

PHILIPS

Curved Business
Monitor

3000 Series



34B2U3600C

EN
User manual

Register your product and get support at www.philips.com/welcome

Table of Contents

| | |
|--|----|
| 1. Important | 1 |
| 1.1 Safety precautions and maintenance | 1 |
| 1.2 Notational Descriptions | 3 |
| 1.3 Disposal of product and packing material | 4 |
| 2. Setting up the monitor | 5 |
| 2.1 Installation | 5 |
| 2.2 Operating the monitor | 8 |
| 2.3 MultiClient Integrated KVM | 10 |
| 2.4 MultiView | 12 |
| 2.5 Remove the Base Assembly for VESA Mounting | 14 |
| 3. Image Optimization | 16 |
| 3.1 SmartImage | 16 |
| 3.2 SmartContrast | 17 |
| 4. Designs to prevent computer vision syndrome (CVS) | 18 |
| 5. Adaptive Sync | 19 |
| 6. Technical Specifications | 20 |
| 6.1 Resolution & Preset Modes | 23 |
| 7. Power Management | 25 |
| 8. Customer care and warranty ... | 26 |
| 8.1 Philips' Flat Panel Displays Pixel Defect Policy | 26 |
| 8.2 Customer Care & Warranty | 29 |
| 9. Troubleshooting & FAQs | 30 |
| 9.1 Troubleshooting | 30 |
| 9.2 General FAQs | 31 |
| 9.3 Multiview FAQs | 34 |

1. Important

This electronic user's guide is intended for anyone who uses the Philips monitor. Take time to read this user manual before you use your monitor. It contains important information and notes regarding the operation of your monitor.

The Philips guarantee applies provided that the product is handled for its intended use, by its operating instructions, and accompanied by the presentation of the original invoice or cash receipt that indicates the date of purchase, dealer's name and model, and production number of the product.

1.1 Safety precautions and maintenance

Warnings

The use of controls, adjustments, or procedures other than those specified in this document may result in exposure to shock, electrical hazards, and/or mechanical hazards.

Read and follow these instructions when connecting and using your monitor.

Excessive sound pressure from earphones and headphones can cause hearing loss. Adjustment of the equalizer to maximum capacity increases the earphones and headphones output voltage; thereby increasing the sound pressure level.

Operation

- Please keep the monitor out of direct sunlight. Lengthy exposure to this type of environment may result in discoloration and damage to the monitor.
- Keep the display away from oil. Oil may damage the plastic cover of the display and void the warranty.
- Remove any object that could fall into ventilation holes or prevent proper cooling of the monitor's electronics.
- Do not block the ventilation holes in the cabinet.
- When positioning the monitor, make sure the power plug and outlet are easily accessible.
- If turning off the monitor by detaching the power cable or DC power cord, wait for 6 seconds before attaching the power cable or DC power cord before returning to normal operation.
- Please use the approved power cord provided by Philips all the times. If your power cord is missing, please contact your local service center. (Please refer to the Service contact information located in the Important information manual.)
- Operate under the specified power supply. Use of incorrect voltage will cause malfunction and may cause fire or electric shock.
- Protect the cable. Do not pull or bend the power cable and signal cable. Do not place the monitor or any other heavy objects on the cables. If damaged, the cables may cause fire or electric shock.
- Do not subject the monitor to severe vibration or high-impact conditions during operation.
- To avoid potential damage, like the panel peeling from the bezel, ensure that the monitor does not tilt downward by more than -5 degrees. If the -5 degree downward tilt angle maximum is exceeded, the monitor damage will not be covered under warranty.

- Do not knock or drop the monitor during operation and/or transportation.
- The USB Type-C port could only be connected to specify equipment with fire enclosure in compliance with IEC 62368-1 or IEC 60950-1.
- Excessive usage of the monitor can cause eye discomfort. It's recommended to take shorter breaks more often at your workstation than longer breaks and less often. For example, a 5-10 minute break after 50-60-minute continuous screen use is likely to be better than a 15-minute break every two hours. Prevent eye strain while using the screen for a constant period by :
 - Looking at something varying distances after a long period of focusing on the screen.
 - Conscious Blinking while you work.
 - Gently closing and rolling your eyes to relax.
 - Reposition your screen to the appropriate height and angle.
 - Adjust the brightness and contrast to an appropriate level.
 - Adjust the environment lighting similar to that of your screen brightness. Avoid fluorescent lighting and surfaces that don't reflect too much light.
 - Seeing a doctor if your symptoms worsen.
- Oil-based cleaning solutions may damage the plastic parts and void the warranty.
- Unplug the monitor if you are not going to use it for an extensive period.
- Unplug the monitor if you need to clean it with a slightly damp cloth. The screen may be wiped with a dry cloth when the power is off. However, never use organic solvents, such as alcohol or ammonia-based liquids.
- To avoid the risk of shock or permanent damage to the set, do not expose the monitor to dust, rain, water, or excessive moisture.
- If your monitor gets wet, wipe it with a dry cloth as soon as possible.
- If a foreign substance or water gets in your monitor, please turn the power off immediately and disconnect the power cord. Then, if damaged, send it to the maintenance center.
- Do not store or use the monitor in locations exposed to heat, direct sunlight, or extreme cold.
- To maintain the best performance of your monitor and use it for a longer lifetime, please use the monitor in a location that falls within the following temperature and humidity ranges:
 - Temperature: 0°C-40°C 32°F-104°F
 - Humidity: 20%-80% RH

Important information for Burn-in/Ghost image

Maintenance

- To protect your monitor from possible damage, do not put excessive pressure on the LCD panel. When moving your monitor, grasp the frame to lift; do not lift the monitor by placing your hand or fingers on the LCD panel.
- Always activate a moving screen saver program when you leave your monitor unattended. Always activate a periodic screen refresh application if your monitor will display unchanging static content. Uninterrupted display of still or static images over an extended period may cause "burn-in",

also known as “after-imaging” or “ghost imaging”, on your screen.

- “Burn-in”, “after-imaging”, or “ghost imaging” is a well-known phenomenon in LCD panel technology. In most cases, the “burn-in”, “after-imaging” or “ghost imaging” will disappear gradually over some time after the power has been switched off.

Warning

Failure to activate a screen saver, or a periodic screen refresh application may result in severe “burn-in” or “after-image” or “ghost image” symptoms that will not disappear and cannot be repaired. The damage mentioned above is not covered under your warranty.

Service

- The casing cover should be opened only by qualified service personnel.
- If there is any need for any document for repair or integration, please contact your local service center. (You can refer to the service contact information listed in the important information manual.)
- For transportation information, please refer to “Technical Specifications”.
- Do not leave your monitor in a car under direct sunlight.

Note

Consult a service technician if the monitor does not operate normally or you are not sure what procedure to take when the operating instructions given in this manual.

1.2 Notational Descriptions

The following subsections describe the notational conventions used in this document.

Notes, Cautions, and Warnings

Throughout this guide, blocks of text may be accompanied by an icon and printed in bold or italic type. These blocks contain notes, cautions, and/or warnings.

They are used as follows:

Note

This icon indicates important information and tips that help you make better use of your computer system.

Caution

This icon indicates information that tells you how to avoid either potential damage to the hardware or loss of data.

Warning

This icon indicates the potential for bodily harm and tells you how to avoid the problem.

Some warnings may appear in alternate formats and may not be accompanied by an icon. In such cases, the specific presentation of the warning is mandated by the relevant regulatory mechanism.

1.3 Disposal of product and packing material

Waste Electrical and Electronic Equipment-WEEE



This marking on the product or its packaging illustrates that, under European Directive 2012/19/EU governing used electrical and electronic appliances, this product may not be disposed with normal household waste. You are responsible for the disposal of this equipment through a designated waste electrical and electronic equipment collection. To determine the locations for dropping off such waste, contact your local government office, the waste disposal organization that serves your household, or the store at which you purchased the product.

Your new monitor contains materials that can be recycled and reused. Specialized companies can recycle your product to increase the number of reusable materials and minimize the amount to be disposed of.

All redundant packing material has been omitted. We have done our utmost to make the packaging easily separable into mono materials.

Please find out about the local regulations on how to dispose of your old monitor and packing from your sales representative.

Taking back/Recycling Information for Customers

Philips establishes technically and economically viable objectives to optimize the environmental performance of the organization's products, services, and activities.

From the planning, design, and production stages, Philips emphasizes the importance of making products that can easily be recycled. At Philips, end-of-life management primarily entails participation in national take-back initiatives and recycling programs whenever possible, preferably in cooperation with competitors, which recycle all materials (products and related packaging material) following all Environmental Laws and taking back programs with the contractor company.

Your display is manufactured with high-quality materials and components which can be recycled and reused.

To learn more about our recycling program please visit:

<http://www.philips.com/a-w/about/sustainability.html>

2. Setting up the monitor

2.1 Installation

1 Package contents

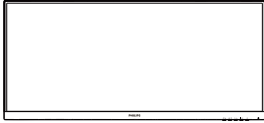

Power



*HDMI



*DP



*USB A-B



*USB C-C



*USB C-A



*USB C-C/A

*Different according to region.

2 Install the base

1. To well protect this monitor and avoid scratching or damaging of the monitor, keep the monitor face down in the cushion for the base installation.

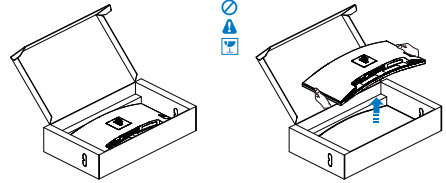

2. Hold the stand with both hands.
 - (1) Gently attach the base to the stand.
 - (2) Use your fingers to tighten the screw located at the bottom of the base, and secure the base to the stand tightly.
 - (3) Gently attach the stand to the VESA mount area until the latch locks the stand.

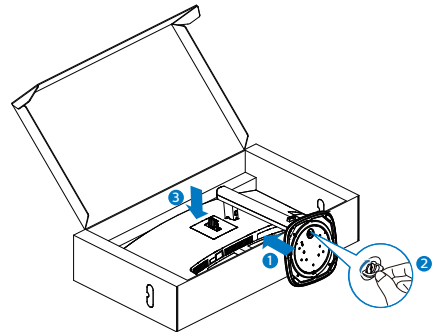

Warning
This product is a curve design. When attaching/detaching the base, place the protective material under the monitor and do not press down on the monitor.

3 Connecting to your PC

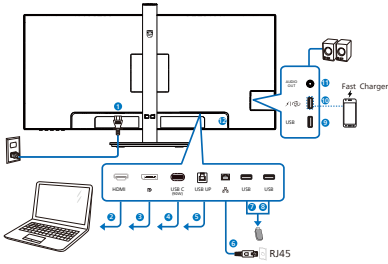

USB docking (USB C-C)

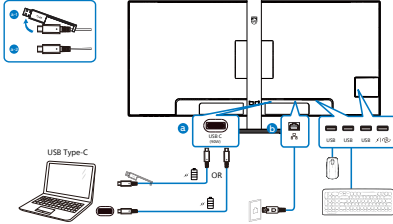

USB hub (USB A-C)

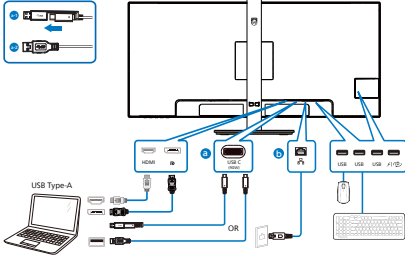

USB hub

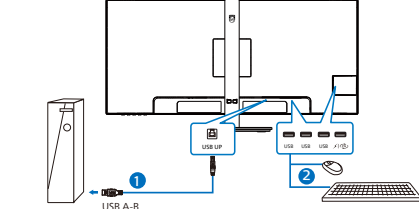

- 1 AC power input
- 2 HDMI input
- 3 DisplayPort input
- 4 USB C (90W)
- 5 USB UP
- 6 RJ45 input

- 7 USB downstream
- 8 USB downstream
- 9 USB downstream
- 10 USB downstream/USB fast charger
- 11 AUDIO OUT
- 12 Kensington anti-theft lock

Connect to PC

1. Connect the power cord to the back of the display firmly.
2. Turn off your computer and unplug its power cable.
3. Connect the monitor signal cable to the video connector on the back of your computer.
4. Plug the power cord of your computer and your monitor into a nearby outlet.
5. Turn on your computer and monitor. If the monitor displays an image, installation is complete.

4 RJ45 driver installation

You can find the "LAN Drivers" from Philips website support page.

Please follow the steps for the installation:

1. Install the LAN driver that matches your system.
2. Double click driver to install, and follow Window's instructions to proceed with installation.
3. It will show "success" when the installation is finished.
4. You must reboot your computer after the installation has completed.
5. Now you will be able to see "Realtek USB Ethernet Network Adapter" from your program installed list.
6. We recommend to periodically visit

the above web link to check for the availability of the most updated driver.

Note

Please contact Philips service hotline for Mac address clone tool as necessary.

5 USB hub

To comply with International energy standards, the USB hub/ports of this monitor are disabled during Standby and Off modes.

Connected USB devices will not work in this state.

To permanently put the USB function in the "ON" state, please go to OSD Menu, then select "USB standby mode", and switch it to the "ON" state. Somehow if your monitor resets to the factory setting, ensure to select "USB standby mode" to "ON" state in the OSD menu.

6 USB charging

This display has USB ports capable of standard power output including some with USB charging functions (identifiable with power icon ). You can use these ports to charge your Smartphone or power your external HDD, for example. The display must be powered ON at all times to be able to use this function.

Some selected Philips displays may not Power or Charge your device when it enters "Sleep/Standby" mode (White power LED blinking). In that case, please enter to OSD Menu and select "USB Standby Mode", then, turn the function to "ON" mode (default=OFF). This will then keep the USB power and charging functions active even when the monitor is in sleep/standby mode.

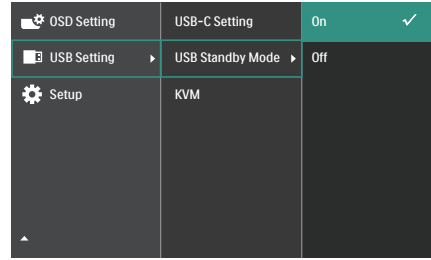

Note

If you Turn OFF your monitor via the power switch at any given time, all the USB ports will power OFF.

 **Warning**
USB 2.4Ghz wireless devices, such as wireless mice, keyboards, and headphoned, may result in decreased efficiency of radio transmission of USB 3.2 or higher version of devices. Should this happen, please try the following methods to help reduce the effects:

- Try to keep USB 2.0 receivers away from a USB 3.2 or higher version of connection port.
- Use a standard USB extension cable or USB hub to increase the space between your wireless receiver and the USB 3.2 or higher version of connection port.

2.2 Operating the monitor

1 Description of the control buttons

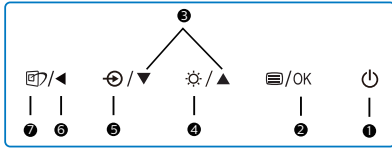
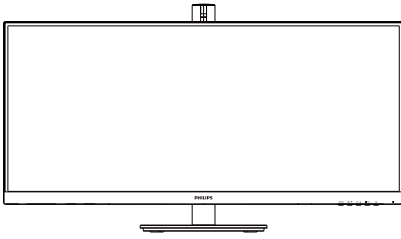

| | | |
|---|--|---|
| 1 | | Switch monitor's power ON or OFF. |
| 2 | | Access the OSD menu. Confirm the OSD adjustment. |
| 3 | | Adjust the OSD menu. |
| 4 | | Adjust the brightness level. |
| 5 | | Change the signal input source. |
| 6 | | Return to previous OSD level. |
| 7 | | SmartImage hot key. There are multiple modes to select: EasyRead, Office, Photo, Movie, Game, Economy, Off. |

2 Description of the On-Screen Display

What is On-Screen Display (OSD)?

On-Screen Display (OSD) is a feature in all Philips LCD monitors. It allows an end user to adjust screen performance or select functions of the monitors directly through an on-screen instruction window. A user-friendly OSD interface is shown below:

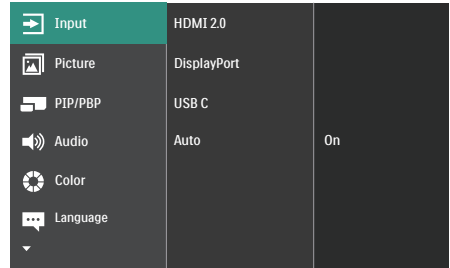

Basic and simple instructions on the control keys

In the OSD shown above, you can press ▼▲ buttons at the front bezel of the monitor to move the cursor, and press OK button to confirm the choice or change.

The OSD Menu

Below is an overall view of the structure of the On-Screen Display. You can use this as a reference when you want to work your way around the different adjustments later on.

| Main menu | Sub menu | |
|-------------|---|--|
| Input | HDMI 2.0 | |
| | DisplayPort USB C Auto | |
| Picture | SmartImage | On, Off |
| | Adaptive Sync | EasyRead, Office, Photo, Movie, Game, Economy, Off |
| | Picture Format | On, Off |
| | Brightness | Wide screen, 4:3, 16:9, Movie 1, Movie 2 |
| | Contrast | 0-100 |
| | Sharpness | 0-100 |
| | SmartResponse | Off, Fast, Faster, Fastest |
| | SmartContrast | On, Off |
| | Gamma | 1.8, 2.0, 2.2, 2.4, 2.6 |
| | Pixel Orbiting | On, Off |
| | Over Scan | On, Off |
| PIP/PBP | PIP / PBP Mode | Off, PIP, PBP |
| | PIP / PBP Input | HDMI 2.0, DisplayPort, USB C |
| | PIP Size | Small, Middle, Large |
| | PIP Position | Top-Right, Top-Left, Bottom-Right, Bottom-Left |
| | Swap | |
| Audio | Volume | 0-100 |
| | Mute | On, Off |
| | Audio Source | HDMI, DisplayPort, USB C |
| Color | Color Temperature | Native, 5000K, 6500K, 7500K, 8200K, 9300K, 11500K |
| | sRGB | |
| | User Define | Red: 0-100 Green: 0-100 Blue: 0-100 |
| Language | English, Deutsch, Español, Ελληνικά , Français, Italiano, Magyar, Nederlands, Portugues, Portugues do Brasil, Polski, Русский , Svenska, Suomi, Türkçe, Čeština, Українська, 简体中文, 繁體中文, 日本語, 한국어 | |
| OSD Setting | Horizontal | 0-100 |
| | Vertical | 0-100 |
| | Transparency | Off, 1, 2, 3, 4 |
| | OSD Time Out | 5s, 10s, 20s, 30s, 60s |
| USB Setting | USB-C Setting | High Data Speed, High Resolution |
| | USB Standby Mode | On, Off |
| | KVM | Auto, USB C, USB Up |
| Setup | Power LED | 0, 1, 2, 3, 4 |
| | Resolution Notification | On, Off |
| | Firmware Upgrade | Yes, No |
| | Reset | Yes, No |
| | Information | |

Note

The Firmware Upgrade option in the OSD menu is only applicable when used with OTG.

3 Resolution notification

This monitor is designed for optimal performance at its native resolution: 3440 x 1440.

When the monitor is powered on at a different resolution, an alert is displayed on the screen as follows: Use 3440 x 1440 for best results.

Display of the native resolution alert can be switched off from Setup in the OSD (On Screen Display) menu.

Note

- The USB hub default setting of USB C input for this monitor is “High Data Speed”. The maximum resolution supported depends on your graphic card capability. If your PC doesn’t support HBR 3, select High Resolution in USB Setting, then the maximum resolution supported will be 3440 x 1440 @75Hz. Press  button > USB Setting > USB > High Resolution
- If your Ethernet connection seems slow, please enter OSD menu and select High Data Speed which supports the LAN speed to 1G.

4 Firmware

There are two ways to perform firmware updates.

1. Over-the-air (OTA)

The over-the-air (OTA) firmware update is through the SmartControl software and is easily downloadable through the Philips website. What does SmartControl do? It is an additional software that helps control the picture, audio, and the other on-screen graphic settings of the monitor.

In the “Setup” section, you can check which firmware version you currently have and if you need to upgrade or not. In addition, it is important to note that the firmware upgrades must be done through the SmartControl software. It is necessary to be connected to a network when updating the firmware on SmartControl over-the-air (OTA).

2. On-the-go (OTG)

This monitor has an OTG function, allowing for direct firmware updates via USB stick. Please contact local customer service before proceeding to obtain relevant information and assistance with the update.

5 Physical Function

Tilt

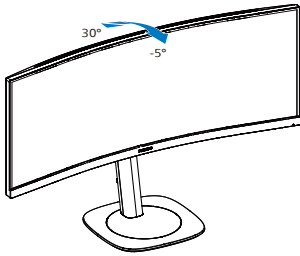

Swivel

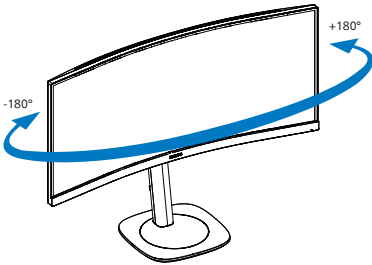

Height adjustment

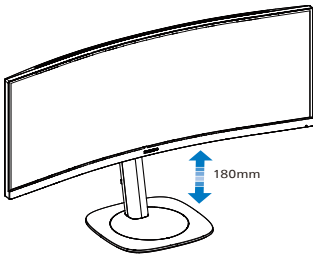

⚠ Warning

- To avoid potential screen damage, such as panel peeling, ensure that the monitor does not tilt downward by more than -5 degrees.
- Do not press the screen while adjusting the angle of the monitor. Grasp only the bezel.

2.3 MultiClient Integrated KVM

1 What is it?

With the MultiClient Integrated Keyboard Video Mouse (KVM) switch feature, it is possible to control two separate PCs with a one monitor/ keyboard/mouse setup.

2 How to enable MultiClient Integrated KVM

With the built-in MultiClient Integrated KVM feature, it's easy to switch between each connected device via the On-Screen Display (OSD) menu setting. For the use of USB-C, HDMI and/or DP as input, use the USB-C cable in the direction of USB Upstream.

Then, connect the upstream cables from your PC to the USB-C and USB UP ports located on the monitor. This process for each PC can be done simultaneously. Please refer to the table and graphic below for more information.

This table explains each source to its corresponding ports on the monitor.

| Source | USB Upstream |
|------------|--------------|
| HDMI or DP | USB UP |
| USB C | USB C |

A Step-by-Step procedure:

1. Connect each cord from the corresponding ports on the monitor, as mentioned in the table above, downstream to each PC.

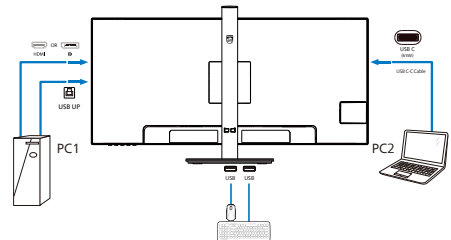

2. Enter the On-Screen Display (OSD) menu. Go to the KVM tab and select "Auto", "USB C", or "USB Up" to switch the monitor view from one device to another. To switch to another monitor view, simply repeat this step.

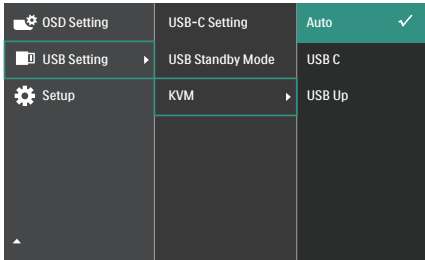

3. Go to the KVM tab and select "Auto", the KVM Smart function can be used.

Users are now able to switch between sources more easily with the latest Smart KVM feature. To move sources, simply click the "ctrl" three times. It would be also available for swapping the Main Picture and the Sub Picture on PIP with Smart KVM.

If you would like to use a DP and/or HDMI cord to input into your device, use the USB-C and USB UP ports with the USB cord being in direction USB upstream.

Please check out the following steps for adjusting the settings for HDMI/DP usage:

1. Connect the USB cable upstream from the PC(s) to the "USB C" and "USB UP" ports of this monitor. This procedure can be done at the same time, if desired.

The dual PC setup should look like this:

PC1: You can use a USB-C/A cable in direction upstream and a HDMI cable or a DP cable and connect it to the USB C port on the monitor

for viewing video and audio content.

PC2: You can use a USB-C/A or USB-C/C cable in direction upstream and a HDMI cable or a DP cable and connect it to the USB-C port on the monitor for viewing video and audio content.

For your convenience. Please use the table below as reference.

| Source | USB Upstream |
|------------|--------------|
| HDMI or DP | USB C |
| DP or HDMI | USB UP |

2. Connect each PC to the downstream end of the USB-C cable.

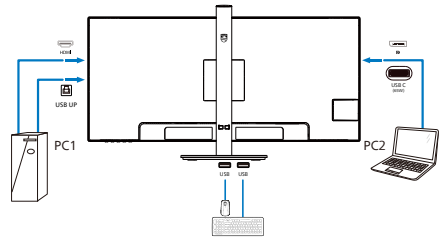

3. Go to the On-Screen Display (OSD) menu and follow the same procedure with the KVM feature as #2 in the previous section.

Note

- Please note that the connection of the input source is not automatic and it is necessary to go to the On-Screen Display (OSD) to select the input you are using.
- You can also ads MultiClient Integrated KVM feature in Picture-by-Picture (PBP) mode. When you enable PBP, you are able to view two different sources projected onto the same screen. The MultiClient Integrated KVM feature enhances productivity by using one screen to control two PCs via the On-Screen Display (OSD) menu setting.

2.4 MultiView



1 What is it?







Multiview enables active variety to connect and view so that you can work with multiple devices like PC and Notebook side-by-side simultaneously, thereby making complex multitasking work a breeze.







2 Why do I need it?

With the ultra-high-resolution Philips MultiView display, you can comfortably experience a world of connectivity in the office or at home. With this display, you can conveniently enjoy multiple content sources on one screen. For example, You may want to keep an eye on the live news video feed with audio in the small window, while working on your latest blog... or you may want to edit an Excel file from your Ultrabook, while logged into a secured company intranet to access files from a desktop.

3 How to enable MultiView by OSD menu?

1. Press  button on the front bezel to enter OSD Menu Screen.

| | | |
|--|---------------|-----------|
|  Input | PIP/PBP Mode | Off |
|  Picture | PIP/PBP Input | HDMI 2.0 |
|  PIP/PBP | PIP Size | Small |
|  Audio | PIP Position | Top-Right |
|  Color | Swap | |
|  Language | | |

2. Press  or  button to select main menu [PIP / PBP], then press **OK** button.
3. Press  or  button to select [PIP / PBP Mode], then press **OK** button.
4. Press  or  button to select [PIP] or [PBP].
5. Now you can move backward to set the [PIP / PBP Input], [PIP Size], [PIP Position], or [Swap].
6. Press **OK** button to confirm your selection.

4 MultiView in OSD menu

- **PIP / PBP Mode:** There are two modes for MultiView: **[PIP]** and **[PBP]**.

[PIP]: Picture in Picture

Open up a sub-window of another signal source.

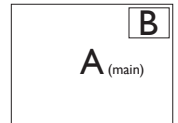

When the sub source is not detected:

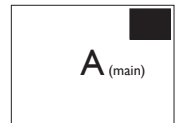

[PBP]: Picture by Picture

Open up a sub-window side-by-side of another signal source.

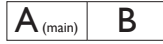

When the sub source is not detected:



Note

The black strip located on the top and the bottom of the screen is for measuring the correct aspect ratio when in the PBP mode. If you expect to see full-screen, adjust your device's resolutions to pop-up attention resolution and you will be able to see 2 devices' source screen project to this display without black strips. It is important to note that the analog signal is not supported on full screen in PBP mode.

- **PIP / PBP Input:** There are different video inputs to choose from as the sub-display source: [HDMI 2.0], [DisplayPort] and [USB C].

Please refer to the table below for compatibility of the main/sub-input source.

| MultiView | | SUB SOURCE POSSIBILITY (x1) | | |
|------------------|-------------|-----------------------------|------|-------------|
| | | Inputs | HDMI | DisplayPort |
| MAIN SOURCE (x1) | HDMI | • | • | • |
| | DisplayPort | • | • | • |
| | USB C | • | • | • |

- **PIP Size:** When PIP is activated, there are three sub-window sizes to choose from [Small], [Middle], and [Large].

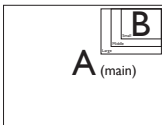

- **PIP Position:** When PIP is activated, there are four sub-window positions to choose from.

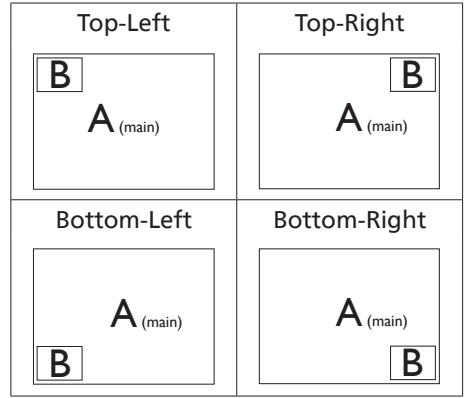

- **Swap:** The main picture source and the sub-picture source are swapped on the display.

Swap A and B source in [PIP] mode:

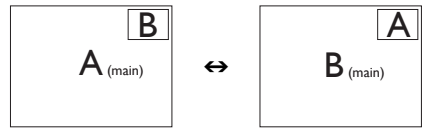

Swap A and B source in [PBP] mode:



- **Off:** Stop MultiView function.



Note

When you activate the SWAP function, the video and its audio source will swap at the same time.

2.5 Remove the Base Assembly for VESA Mounting

Before you start disassembling the display base, please follow the instructions below to avoid any possible damage or injury.

1. Place the monitor face down on a smooth surface. Pay attention not to scratch or damage the screen. Then lift the monitor stand.

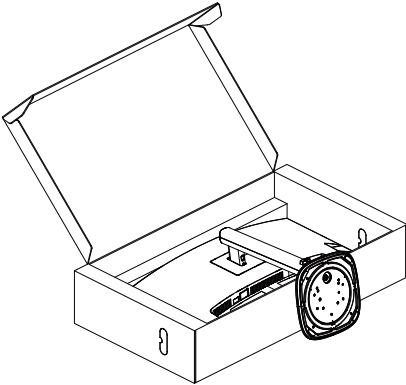

2. While keeping the release button pressed, tilt the base and slide it out.

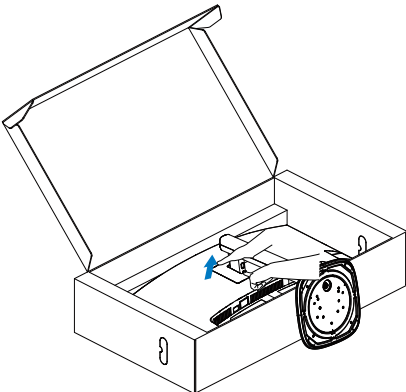

3. Use your finger to pick the groove of the VESA closure to remove it.

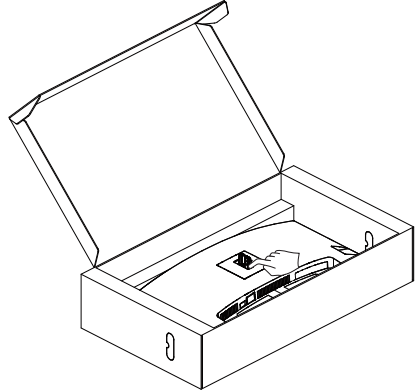

4. Remove the VESA Cover

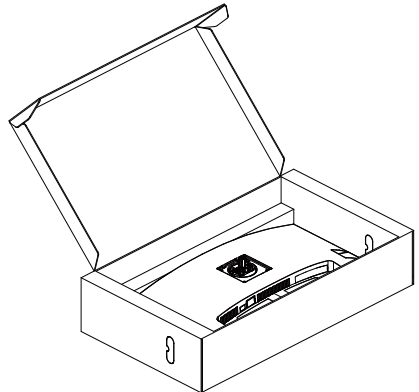

Note
This monitor accepts a 100mm x 100mm VESA-Compliant mounting interface. VESA Mounting Screw M4. Always contact the manufacturer for wall-mount installation.

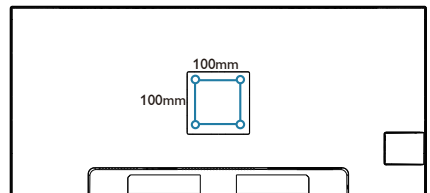

 Warning

This product is a curve design, when attaching/detaching the base, place the protective material under the monitor and, to avoid damage, do not press down on the monitor.

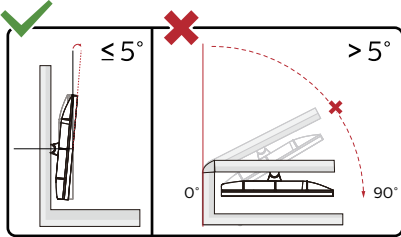

* Display design may differ from those illustrated in this manual.

 Warning

- To avoid potential screen damage, such as panel peeling, ensure that the monitor does not tilt downward by more than -5 degrees.
- Do not press the screen while adjusting the angle of the monitor. Grasp only the bezel.

3. Image Optimization

3.1 SmartImage

1 What is it?

SmartImage provides presets that optimize display for different types of content, dynamically adjusting brightness, contrast, color, and sharpness in real-time. Whether you're working with text applications, displaying images, or watching a video, Philips SmartImage delivers great monitor performance.

2 Why do I need it?

It is ideal to have a monitor that delivers an optimized display of all your favorite types of content. Our SmartImage software dynamically adjusts brightness, contrast, color, and sharpness in real-time to enhance your monitor viewing experience.

3 How does it work?

SmartImage is an exclusive, leading-edge Philips technology that analyzes the content displayed on your screen. Based on the scenario you select, SmartImage dynamically enhances the contrast, color saturation, and sharpness of images to enhance the contents being displayed - all in real time by the press of a single button.

4 How to enable SmartImage?

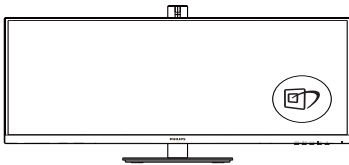

1. Press  to launch the SmartImage on-screen display.
2. Keep pressing   to toggle among EasyRead, Office, Photo, Movie,

Game, Economy and Off.

3. The SmartImage on-screen display will remain on screen for 5 seconds, or you can also press "OK" to make confirmation.

There are multiple modes to select: EasyRead, Office, Photo, Movie, Game, Economy and Off.

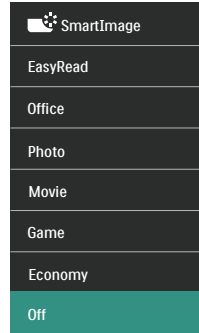

- **EasyRead:** Helps improve reading of text-based applications like PDF ebooks. By using a special algorithm that increases the contrast and boundary sharpness of text content. The display is optimized for a stress-free reading by adjusting the brightness, contrast, and color temperature of the monitor.
- **Office:** Enhances text and dampens brightness to increase readability and reduce eye strain. This mode significantly enhances readability and productivity when you're working with spreadsheets, PDF files, scanned articles or other general office applications.
- **Photo:** This profile combines color saturation, dynamic contrast and sharpness enhancement to display photos and other images with outstanding clarity in vibrant colors - all without artifacts and faded colors.

- **Movie:** Ramped up luminance, deepened color saturation, dynamic contrast, and razor sharpness displays every detail in darker areas of your videos without experiencing color washout.
- **Game:** Turn on over drive circuit for best response time, reduce jaggy edges for fast moving objects on screen, enhance contrast ratio for bright and dark scheme, this profile delivers the best gaming experience for gamers.
- **Economy:** Under this profile, brightness and contrast are adjusted and backlighting is fine-tuned to produce the right display for everyday office applications.
- **Off:** No optimization by SmartImage.

3.2 SmartContrast

1 What is it?

It is a unique technology that dynamically analyzes displayed content and automatically optimizes a monitor's contrast ratio for maximum visual clarity and viewing enjoyment.

2 Why do I need it?

Because SmartContrast offers the best visual clarity and viewing comfort for every type of content. It dynamically controls contrast and adjusts backlighting for bright gaming and video imagery. In addition, by reducing your monitor's power consumption, you save on energy costs and extend the lifetime of your monitor.

3 How does it work?

When you activate SmartContrast, it will analyze the content you are displaying in real time to adjust colors and control backlight intensity. This function will dynamically enhance contrast for a great entertainment experience when viewing videos or playing games.

4. Designs to prevent computer vision syndrome (CVS)

Philips monitor is designed to prevent eye strain caused by prolonged computer use.

Follow the below instructions and use a Philips monitor to efficiently reduce fatigue and maximize working productivity.

1. Appropriate environment lighting:
 - Adjust the environment lighting similar to that of your screen brightness, avoid fluorescent lighting, and surfaces that don't reflect too much light.
 - Adjust the brightness and contrast to the appropriate level.
2. Good working habits:
 - Excessive usage of the monitor can cause eye discomfort, it's better to take shorter breaks more often at your workstation than longer breaks and less often; for example a 5-10 minute break after 50-60-minute continuous screen use is likely to be better than a 15-minute break every two hours.
 - Looking at something varying distances after a long period of focusing on the screen.
 - Gently closing and rolling your eyes to relax.
 - Conscious blinking often while working.
 - Gently stretch your neck, and slowly tilt your head forward, backward, and side for pain relief.

3. Ideal working posture
 - Reposition your screen to the appropriate measurement according to your own height.
4. Choose a Philips monitor for viewing that is easy on the eyes.
 - Anti-glare screen: This feature efficiently reduces annoying and distracting reflections that is associated with eye fatigue.
 - Flicker-free technology is designed to regulate brightness and reduce flicker for more comfortable viewing.
 - EasyRead mode for a paper-like reading experience, giving a more comfortable viewing experience while dealing with long documents on the screen.
 - The Monitor uses low blue light panel and compliance with TÜV Rheinland Low Blue Light Hardware Solution at factory reset/default setting mode.

5. Adaptive Sync



Adaptive Sync

PC gaming has long had an imperfect experience because GPUs and monitors update at different rates. Sometimes a GPU can render many new pictures during a single update of the monitor and the monitor will show pieces of each picture as a single image. This is called “tearing.” Gamers can fix tearing with a feature called “v-sync,” but the image can become jerky as the GPU waits on the monitor to call for an update before delivering new pictures.

The responsiveness of mouse input and overall frames per second is reduced with v-sync, too. AMD Adaptive Sync technology eliminates all of these problems by letting the GPU update the monitor the moment a new picture is ready. Therefore, this feature leaves gamers with unbelievably smooth, responsive, tearing-free gaming.

Followed by the graphic card that are compatible.

- AMD Radeon R7 260X
- AMD Radeon R7 260
- Processor A-Series Desktop and Mobility APUs
 - AMD A10-7890K
 - AMD A10-7870K
 - AMD A10-7850K
 - AMD A10-7800
 - AMD A10-7700K
 - AMD A8-7670K
 - AMD A8-7650K
 - AMD A8-7600
 - AMD A6-7400K
 - AMD RX 6500 XT
 - AMD RX 6600 XT
 - AMD RX 6700 XT
 - AMD RX 6750 XT
 - AMD RX 6800
 - AMD RX 6800 XT
 - AMD RX 6900 XT
- Operating system
 - Windows 11/10
- Graphic Card: R9 290/300 Series & R7 260 Series
 - AMD Radeon R9 300 Series
 - AMD Radeon R9 Fury X
 - AMD Radeon R9 360
 - AMD Radeon R7 360
 - AMD Radeon R9 295X2
 - AMD Radeon R9 290X
 - AMD Radeon R9 290
 - AMD Radeon R9 285

6. Technical Specifications

| Picture/Display | |
|------------------------------|---|
| Display Panel Type | VA |
| Backlight | W-LED |
| Panel Size | 34" W (86.36 cm) |
| Aspect Ratio | 16:9 |
| Pixel Pitch | 0.23175(W) x 0.23175(H) |
| Contrast ratio(typical) | 3500:1 |
| Native Resolution | 3440 x 1440 @ 60 Hz |
| Maximum Resolution | 3440 x 1440 @ 100 Hz (HDMI) 3440 x 1440 @ 120 Hz (DP/USB C) |
| Viewing Angle | 178° (H) / 178° (V) @ C/R > 10 (Typ.) |
| Picture Enhancement | SmartImage |
| Display Colors | 1.07 B (8 Bit + FRC) ¹ |
| Vertical Refresh Rate | 48 - 100 Hz (HDMI) 48 - 120 Hz (DP/USB C) |
| Horizontal Frequency | 30 - 160 KHz (HDMI) 30 - 190 KHz (DP/USB C) |
| sRGB | YES |
| EasyRead | YES |
| Flicker Free | YES |
| Adaptive Sync | YES |
| Over-the-air firmware update | YES |
| Connectivity | |
| Signal Input source | HDMI, DisplayPort, USB C (DP Alt mode) |
| Connectors | 1 x HDMI 2.0 (HDCP 1.4, HDCP 2.2) 1 x DisplayPort 1.4 (HDCP 1.4, HDCP 2.2) 1 x USB-C (upstream, HDCP 1.4, HDCP 2.2) 1 x USB-B (upstream) 4 x USB-A (downstream with x1 fast charge BC 1.2) 1 x RJ45, Ethernet LAN (USB 2.0: 10M/100M; USB 3.0: 1000M) 1 x Audio Out |
| Sync input | Separate Sync |
| USB | |
| USB Ports | USB UP x1 (upstream) USB C x1 (upstream, typical PD 90W, DP Alt mode) USB-A x4 (downstream with x1 fast charge B.C 1.2) |
| Power Delivery | USB C: USB PD version 3.0, typical 90W (5V/3A, 7V/3A, 9V/3A, 10V/3A, 12V/3A, 15V/3A, 20V/4.5A) USB-A: x1 fast charge B.C 1.2, up to 7.5W (5V/1.5A) |
| USB SuperSpeed | USB-C/USB-A: USB 3.2 Gen1, 5 Gbps |

| Convenience | | | |
|--------------------------------|---|-----------------------------------|-----------------------------------|
| USER convenience | | | |
| Built-in speaker | 5 W x 2 | | |
| MultiView | PIP/PBP mode, 2xdevices | | |
| OSD Languages | English, German, Spanish, Greek, French, Italian, Hungarian, Dutch, Portuguese, Brasil Portuguese, Polish, Russian, Swedish, Finnish, Turkish, Czech, Ukranian, Simplified Chinese, Traditional Chinese, Japanese, Korean | | |
| Other Convenience | VESA mount(100x100mm), Kensington Lock | | |
| Plug & Play Compatibility | DDC/CI, Mac OS X, sRGB, Windows 11/10 | | |
| Stand | | | |
| Tilt | -5 / +30 degree | | |
| Swivel | -180 / +180 degree | | |
| Height adjustment | 180 mm | | |
| Power | | | |
| Consumption | AC Input Voltage at 100VAC , 50Hz | AC Input Voltage at 115VAC , 60Hz | AC Input Voltage at 230VAC , 50Hz |
| Normal Operation | 34.6 W (typ.) | 34.4 W (typ.) | 33.5 W (typ.) |
| Sleep (Standby mode) | 0.3 W(typ.) | 0.3 W(typ.) | 0.3 W(typ.) |
| Off mode | 0.3 W(typ.) | 0.3 W(typ.) | 0.3 W(typ.) |
| Off mode(AC switch) | 0 W(typ.) | 0 W(typ.) | 0 W(typ.) |
| Heat Dissipation* | AC Input Voltage at 100VAC , 50Hz | AC Input Voltage at 115VAC , 60Hz | AC Input Voltage at 230VAC , 50Hz |
| Normal Operation | 118.09 BTU/hr (typ.) | 117.41 BTU/hr (typ.) | 114.33 BTU/hr (typ.) |
| Sleep (Standby mode) | 1.02 BTU/hr(typ.) | 1.02 BTU/hr(typ.) | 1.02 BTU/hr(typ.) |
| Off mode | 1.02 BTU/hr(typ.) | 1.02 BTU/hr(typ.) | 1.02 BTU/hr(typ.) |
| Off mode(AC switch) | 0 BTU/hr(typ.) | 0 BTU/hr(typ.) | 0 BTU/hr(typ.) |
| On Mode(ECO mode) | 20.2 W (typ.) | | |
| Power LED indicator | On mode: White, Standby/Sleep mode: White (blinking) | | |
| Power Supply | Built-in, 100-240V AC, 50/60Hz | | |
| Dimensions | | | |
| Product with stand (WxHxD) | 807 x 602 x 287 mm | | |
| Product without stand (WxHxD) | 807 x 369 x 107 mm | | |
| Product with packaging (WxHxD) | 930 x 525 x 188 mm | | |

| Weight | |
|--------------------------------------|---------------------------|
| Product with stand | 10.41 kg |
| Product without stand | 7.82 kg |
| Product with packaging | 15.35 kg |
| Operating Condition | |
| Temperature range (operation) | 0°C to 40 °C |
| Relative humidity (operation) | 20% to 80% |
| Atmospheric pressure (operation) | 700 to 1060hPa |
| Temperature range (Non-operation) | -20°C to 60°C |
| Relative humidity (Non-operation) | 10% to 90% |
| Atmospheric pressure (Non-operation) | 500 to 1060hPa |
| Environmental and energy | |
| ROHS | YES |
| Packaging | 100% recyclable |
| Specific Substances | 100% PVC BFR free housing |
| Cabinet | |
| Color | Black |
| Finish | Texture |

¹ For more information, please refer to Chapter 6.1 on Display Input Format.

 **Note**

1. This data is subject to change without notice. Go to www.philips.com/support to download the latest version of leaflet.
2. In order to update the monitor's firmware to the latest version, Please download the SmartControl software from Philips website. It is necessary to be connected to a network when updating the firmware on SmartControl over-the-air (OTA).

6.1 Resolution & Preset Modes

| H. freq (kHz) | Resolution | V. freq (Hz) |
|---------------|-----------------------|-------------------|
| 31.47 | 720x400 | 70.09 |
| 31.47 | 640x480 | 59.94 |
| 35.00 | 640x480 | 66.67 |
| 37.86 | 640x480 | 72.81 |
| 37.50 | 640x480 | 75.00 |
| 35.16 | 800x600 | 56.25 |
| 37.88 | 800x600 | 60.32 |
| 48.08 | 800x600 | 72.19 |
| 46.88 | 800x600 | 75.00 |
| 47.73 | 832x624 | 74.55 |
| 48.36 | 1024x768 | 60.00 |
| 56.48 | 1024x768 | 70.07 |
| 60.02 | 1024x768 | 75.03 |
| 44.77 | 1280x720 | 59.86 |
| 63.89 | 1280x1024 | 60.02 |
| 79.98 | 1280x1024 | 75.03 |
| 55.94 | 1440x900 | 59.89 |
| 65.29 | 1680x1050 | 59.95 |
| 89.48 | 1720x1440 | 59.97 |
| 89.48 | 1720x1440 PBP Mode | 59.94 |
| 111.98 | 1720x1440 PBP Mode | 75.00 |
| 67.50 | 1920x1080 | 60.00 |
| 67.17 | 2560x1080 | 59.98 |
| 44.41 | 3440x1440 | 29.99 |
| 88.82 | 3440x1440 | 59.97 |
| 150.97 | 3440x1440 | 99.98 |
| 181.2 | 3440x1440 | 120.0 DP/USB C |

Note

1. Please notice that your display works best at native resolution of 3440 x 1440 @ 60Hz. For best display quality, please follow this resolution recommendation. Recommended resolution HDMI 2.0/DP/USB C:3440 x 1440 @ 60Hz If your display is not on the native resolution when connecting to USB C or DP port, please adjust resolution to the optimal state: 3440 x 1440 @60 Hz from your PC.
2. The factory default setting HDMI supports to the resolution 3440 x 1440 @ 60Hz.
3. The USB hub default setting of USB C input for this monitor is "High Data Speed". The maximum resolution supported depends on your graphic card capability.If your PC doesn't support HBR 3, select "High Resolution" in USB Setting, then the maximum resolution supported will be 3440 x 1440 @120Hz.Press  button > USB Setting > USB > High Resolution

Display Input Format

| | 422/420 | 444/RGB | 422/420 | 444/RGB | 422/420 | | 444/RGB | |
|----------------------------|-----------|-----------|---------|---------|-----------------|-----------------|-----------------|-----------------|
| | (HDMI2.0) | (HDMI2.0) | (DP1.4) | (DP1.4) | USBC@ USB3.2 | USBC@ USB2.0 | USBC@ USB3.2 | USBC@ USB2.0 |
| 3440 x 1440 @120Hz, 10bits | N/A | N/A | OK | OK | OK | OK | N/A | OK |
| 3440 x 1440 @120Hz, 8bits | N/A | N/A | OK | OK | OK | OK | N/A | OK |
| 3440 x 1440 @100Hz, 10bits | N/A | N/A | OK | OK | OK | OK | OK | OK |
| 3440 x 1440 @100Hz, 8bits | OK | OK | OK | OK | OK | OK | OK | OK |
| 3440 x 1440 @60Hz, 10bits | OK | OK | OK | OK | OK | OK | OK | OK |
| 3440 x 1440 @60Hz, 8bits | OK | OK | OK | OK | OK | OK | OK | OK |
| Minimum:1920 x 1080 @ 60Hz | OK | OK | OK | OK | OK | OK | OK | OK |

Note

In order for the monitor to function properly, your PC's graphics card must support DisplayPort 1.4 or HDMI 2.0. The display resolution and refresh rate are also dependent on the computer's graphic card capability.

7. Power Management

If you have a VESA DPM compliance display card or software installed on your PC, the monitor can automatically reduce its power consumption when not in use. If an input from a keyboard, mouse, or other input device is detected, the monitor will 'wake up' automatically. The following table shows the power consumption and signaling of this automatic power saving feature:

| Power Management Definition | | | | | |
|-----------------------------|-------|--------|--------|---------------------------------|---------------|
| VESA Mode | Video | H-sync | V-sync | Power Used | LED Color |
| Active | ON | Yes | Yes | 34.4 W (typ.) 198.8 W (max.) | White |
| Sleep (Standby mode) | OFF | No | No | 0.3 W (typ.) | White (blink) |
| Off mode (AC switch) | OFF | - | - | 0W (AC switch) | OFF |

The following setup is used to measure power consumption on this display.

- Native resolution: 3440 x 1440
- Contrast: 50%
- Brightness: 20%
- Color temperature: 6500k with full white pattern
- Audio and USB Inactive (Off)

Note

This data is subject to change without notice.

8. Customer care and warranty

8.1 Philips' Flat Panel Displays Pixel Defect Policy

Philips strives to deliver the highest quality products. We use some of the industry's most advanced manufacturing processes and practice stringent quality control. However, pixel or sub-pixel defects on the TFT Monitor panels used in flat panel monitors are sometimes unavoidable. No manufacturer can guarantee that all panels will be free from pixel defects, but Philips guarantees that any monitor with an unacceptable number of defects will be repaired and/or replaced under warranty. This notice explains the different types of pixel defects and defines acceptable defect levels for each type. To qualify for repair or replacement under warranty, the number of pixel defects on a TFT Monitor panel must exceed these acceptable levels. For example, no more than 0.0004% of the sub-pixels on a monitor may be defective. Furthermore, Philips sets even higher quality standards for certain types or combinations of pixel defects that are more noticeable than others. This policy is valid worldwide.

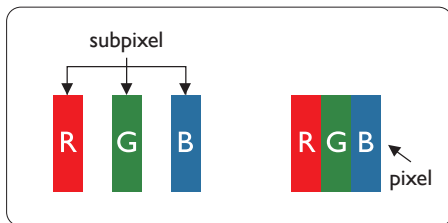

Pixels and Sub pixels

A pixel, or picture element, is composed of three sub-pixels in the primary colors of red, green, and blue. Many pixels

together form an image. When all the sub-pixels of a pixel are lit, the three colored sub-pixels together appear as a single white pixel. When all are dark, the three colored sub-pixels together appear as a single black pixel. Other combinations of lit and dark sub-pixels appear as single pixels of other colors.

Types of Pixel Defects

Pixel and sub-pixel defects appear on the screen in different ways. There are two categories of pixel defects and several types of sub-pixel defects within each category.

Bright Dot Defects

Bright dot defects appear as pixels or sub-pixels that are always lit or 'on'. Meaning, a bright dot is a sub-pixel that stands out on the screen when the monitor displays a dark pattern. There are three types of bright dot defects: One lit red, green, or blue sub-pixel.

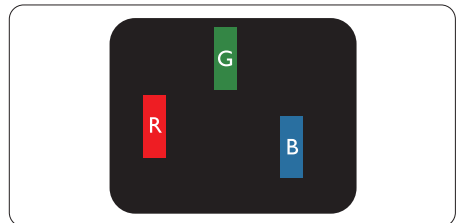

One lit red, green or blue sub pixel.

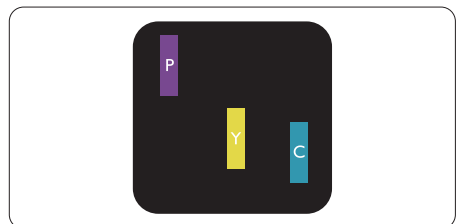

Two adjacent lit sub-pixels:

- Red + Blue = Purple
- Red + Green = Yellow
- Green + Blue = Cyan (Light Blue)

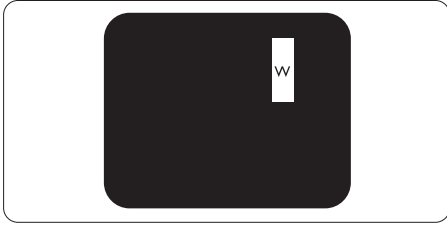

Three adjacent lit sub pixels (one white pixel).

Note
A red or bright blue dot must be more than 50 percent brighter than neighboring dots, while a bright green dot is 30 percent brighter than neighboring dots.

Black Dot Defects

Black dot defects appear as pixels or sub-pixels that are always dark or 'off'. Meaning, a dark dot is a sub-pixel that stands out on the screen when the monitor displays a light pattern. These are the types of black dot defects.

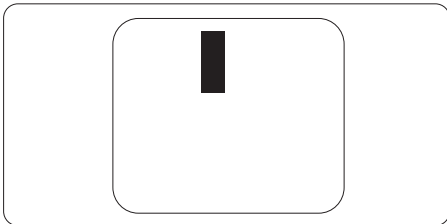

Proximity of Pixel Defects

Because pixel and sub pixels defects of the same type that are near to one another may be more noticeable, Philips also specifies tolerances for the proximity of pixel defects.

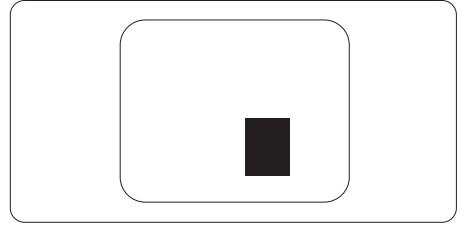

Pixel Defect Tolerances

To qualify for repair or replacement due to pixel defects during the warranty period, a TFT Monitor panel in a Philips flat panel monitor must have pixel or sub-pixel defects exceeding the tolerances listed in the following tables.

| BRIGHT DOT DEFECTS | ACCEPTABLE LEVEL |
|--|-------------------------|
| 1 lit subpixel | 2 |
| 2 adjacent lit subpixels | 1 |
| 3 adjacent lit subpixels (one white pixel) | 0 |
| Distance between two bright dot defects* | >15mm |
| Total bright dot defects of all types | 2 |
| BLACK DOT DEFECTS | ACCEPTABLE LEVEL |
| 1 dark subpixel | 3 or fewer |
| 2 adjacent dark subpixels | 2 or fewer |
| 3 adjacent dark subpixels | 1 |
| Distance between two black dot defects* | >15mm |
| Total black dot defects of all types | 3 or fewer |
| TOTAL DOT DEFECTS | ACCEPTABLE LEVEL |
| Total bright or black dot defects of all types | 5 or fewer |

 **Note**

1 or 2 adjacent sub pixel defects = 1 dot defect

8.2 Customer Care & Warranty

For warranty coverage information and additional support requirements valid for your region, please visit www.philips.com/support website for details or contact your local Philips Customer Care Center.

For the Warranty Period please refer to Warranty Statement in the Important information manual.

For an extended warranty, if you would like to extend your general warranty period, an Out of Warranty service package is offered via our Certified Service Center.

If you wish to make use of this service, please be sure to purchase the service within 30 calendar days of your original purchase date. During the extended warranty period, the service includes pickup, repair, and return service, however, the user will be responsible for all costs accrued.

If the Certified Service Partner cannot perform the required repairs under the offered extended warranty package, we will find alternative solutions for you, if possible, up to the extended warranty period you have purchased.

Please contact our Philips Customer Service Representative or local contact center (by Consumer care number) for more details.

Philips Customer Care Center number listed below.

| • Local Standard Warranty Period | • Extended Warranty Period | • Total Warranty Period |
|----------------------------------|----------------------------|-------------------------------------|
| • Depend on different Regions | • + 1 Year | • Local Standard warranty period +1 |
| | • + 2 Years | • Local Standard warranty period +2 |
| | • + 3 Years | • Local Standard warranty period +3 |

**Proof of original purchase and extended warranty purchase required.

Note

Please refer to the [Important information manual for the regional service hotline](#), which is available on the [Philips website support page](#).

9. Troubleshooting & FAQs

9.1 Troubleshooting

This page deals with problems that can be corrected by a user. If the problem persists after you have tried these solutions, contact a Philips customer service representative.

1 Common Problems

No Picture (Power LED not lit)

- Make sure the power cord is plugged into the power outlet and the back of the monitor.
- First, ensure that the power button on the front of the display is in the OFF position, then press it to the ON position.

No Picture (Power LED is White)

- Make sure the computer is turned on.
- Make sure the signal cable is properly connected to your computer.
- Make sure the monitor cable has no bent pins on the connecting side. If yes, repair or replace the cable.
- The Energy Saving feature may be activated Screen says

Check cable connection

- Make sure the display cable is properly connected to your computer. (Also refer to the Quick Start Guide).
- Check to see if the display cable has bent pins.

- Make sure the computer is turned on.

Visible signs of smoke or sparks

- Do not perform any troubleshooting steps
- Disconnect the monitor from the mains power source immediately for safety
- Contact Philips customer service representative immediately.

2 Imaging Problems

The image appears blurred, indistinct, or too dark

- Adjust the contrast and brightness on On-Screen Display.

An "after-image", "burn-in" or "ghost image" remains after the power has been turned off.

- Uninterrupted display of still or static images over an extended period may cause "burn-in", also known as "after-imaging" or "ghost imaging", on your screen. "Burn-in", "after-imaging", or "ghost imaging" is a well-known phenomenon in LCD panel technology. In most cases, the "burn-in" "after-imaging" or "ghost imaging" will disappear gradually over some time after the power has been switched off.
- Always activate a moving screen saver program when you leave your display unattended.
- Always activate a periodic screen refresh application if your LCD display will display unchanging static content.
- Failure to activate a screen saver, or a periodic screen refresh application may result in severe "burn-in", "after-imaging" or "ghost imaging"

symptoms that will not disappear and cannot be repaired. The damage mentioned above is not covered under your warranty.

The image appears distorted or the text is fuzzy or blurred.

- Set the PC's display resolution to the same mode as the monitor's recommended screen native resolution.

Green, red, blue, dark, and white dots appear on the screen

- The remaining dots are a normal characteristic of the liquid crystal used in today's technology, Please refer to the pixel policy for more detail.

* The "power on" light is too strong and is disturbing

- You can adjust the "power on" light using the power LED Setup in OSD Main Controls.

For further assistance, refer to the Service contact information listed in the Important information manual and contact a Philips customer service representative.

* [Functionality is different according to display.](#)

9.2 General FAQs

Q1: When I install my display what should I do if the screen shows 'Cannot display this video mode'?

Ans.: Recommended resolution for this display: 3440 x 1440.

- Unplug all cables, then connect your PC to the display that you used previously.
- In the Windows Start Menu, select Settings/Control Panel. In the Control Panel Window, select the Display icon. Inside the Display Control Panel, select the 'Settings' tab. Under the setting tab, in the box labeled 'desktop area', move the sidebar to 3440 x 1440 pixels.
- Open 'Advanced Properties' and set the Refresh Rate to 60 Hz, then click OK.
- Restart your computer and repeat steps 2 and 3 to verify that your PC is set at 3440 x 1440.
- Shut down your computer, disconnect your old monitor, and reconnect your Philips LCD monitor.
- Turn on your display and then turn on your PC.

Q2: What is the recommended refresh rate for an LCD monitor?

Ans.: Recommended refresh rate in LCD monitors is 60 Hz, In case of any disturbance on the screen, you can set it up to 75 Hz to see if that removes the disturbance.

Q3: What are the .inf and .icm files? How do I install the drivers (.inf and .icm)?

Ans.: These are the driver files for your monitor. Your computer may ask you for monitor drivers (.inf and .icm files) when you first install your monitor. Follow the instructions in your user manual, and monitor drivers (.inf and .icm files) will be installed automatically.

Q4: How do I adjust the resolution?

Ans.: Your video card/graphic driver and display together determine the available resolutions. You can select the desired resolution under Windows® Control Panel with the "Display properties".

Q5: What if I get lost when I am making display adjustments via OSD?

Ans.: Simply press  button, then select 'Setup' > 'Reset' to recall all the original factory settings.

Q6: Is the LCD screen resistant to scratches?

Ans.: In general it is recommended that the panel surface is not subjected to excessive shocks and is protected from sharp or blunt objects. When handling the display, make sure that there is no pressure or force applied to the panel surface side. This may affect your warranty conditions.

Q7: How should I clean the LCD surface?

Ans.: For normal cleaning, use a clean, soft cloth. For extensive cleaning, please use isopropyl alcohol. Do not use other solvents such as

ethyl alcohol, ethanol, acetone, hexane, etc.

Q8: Can I change the color setting of my display?

Ans.: Yes, you can change your color setting through OSD control as per the following procedures.

- Press "OK" to show the OSD (On Screen Display) menu
- Press "Down Arrow" to select the option "Color" then press "OK" to enter the color setting, there are three settings as below.
 1. Color Temperature: The settings are as follows. Native, 5000K, 6500K, 7500K, 8200K, 9300K, and 11500K. With settings in the 5000K range the panel appears "warm, with a red-white color tone", while a 11500K temperature yields "cool, blue-white toning".
 2. sRGB: This is a standard setting for ensuring the correct exchange of colors between different devices (e.g. digital cameras, monitors, printers, scanners, etc).
 3. User Define: The user can choose his/her preferred color setting by adjusting red, green, and blue colors.

 **Note**

A measurement of the color of light radiated by an object while it is being heated. This measurement is expressed in terms of absolute scale, (degrees Kelvin). Lower Kelvin temperatures such as 2004K are red; higher temperatures such as 9300K are blue. The neutral temperature is white, at 6504K.

Q9: Can I connect my LCD monitor to any PC, workstation, or Mac?

Ans.: Yes. All Philips LCD monitors are fully compatible with standard PCs, Macs, and workstations. You may need a cable adapter to connect the monitor to your Mac system. Please contact your Philips sales representative for more information.

Q10: Are Philips LCD displays Plug-and-Play?

Ans.: Yes, the displays are Plug-and-Play compatible with Windows 11/10

Q11: What is Image Sticking, Image Burn-in, After Image, or Ghost Image in LCD panels?

Ans.: Uninterrupted display of still or static images over an extended period may cause "burn in", also known as "after-imaging" or "ghost imaging", on your screen. "Burn-in", "after-imaging", or "ghost imaging" is a well-known phenomenon in LCD panel technology. In most cases, the "Burn-in" or "after-imaging" or "ghost imaging" will disappear gradually over a period of time after the power has been switched off.

Always activate a moving screen saver program when you leave your display unattended.

Always activate a periodic screen refresh application if your LCD display will display unchanging static content.





Warning

Failure to activate a screen saver, or a periodic screen refresh application may result in severe "burn-in" "after-image" or "ghost image" symptoms that will not disappear and cannot be repaired. The damage mentioned above is not covered under your warranty.

Q12: Why is my Display not showing sharp text, and is displaying jagged characters?

Ans.: Your LCD monitor works best at its native resolution of 3440 x 1440. For the best display, please use this resolution.

Q13: How to unlock/lock my hotkey?

Ans.: To lock the OSD, press and hold the /OK button while the monitor is off and then press  button to turn the monitor on. To un-lock the OSD, press and hold the /OK button while the monitor is off and then press  button to turn the monitor on.



Display controls unlocked

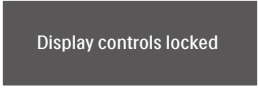

Display controls locked

Q14: Where can I find the Important information manual mentioned in EDFU?

Ans.: Important information manual can be downloaded on the Philips website support page.

9.3 Multiview FAQs

Q1: Can I enlarge the PIP sub-window?

Ans.: Yes, there are 3 sizes to select: [Small], [Middle], [Large]. You can press  to enter the OSD menu. Select your preferred [PIP Size] option from the [PIP / PBP] main menu.

Q2: How to listen to Audio, independent of a video?

Ans.: Normally the audio source is linked to the main picture source. If you want to change audio-source input, you can press  enter in the OSD menu. Select your preferred [Audio Source] option from the [Audio] main menu.

Please note that the next time you turn on your display, the display will by default select the audio source you chose last time. In case you want to change it again, you need to go through the above steps to select your new preferred audio source, which then will become the "default" mode.

Q3: Why do the sub-windows flicker when I enable PIP/PBP?

Ans: It's because the sub-windows video source is interlace timing (i-timing), please change the sub-window signal source to progressive timing (P-timing).



2024 © TOP Victory Investments Ltd. All rights reserved.

This product has been manufactured by and is sold under the responsibility of Top Victory Investments Ltd., and Top Victory Investments Ltd. is the warrantor in relation to this product. Philips and the Philips Shield Emblem are registered trademarks of Koninklijke Philips N.V. and are used under license.

Specifications are subject to change without notice.

Version: 34B2U3600E1WWT