

Dell Silent Mouse MS355

User's Guide

Notes, cautions, and warnings

 **NOTE:** A NOTE indicates important information that helps you make better use of your product.

 **CAUTION:** A CAUTION indicates either potential damage to hardware or loss of data and tells you how to avoid the problem.



 **WARNING:** A WARNING indicates a potential for property damage, personal injury, or death.

Contents

What's in the box	4
Features	5
Dell Peripheral Manager	6
Setting up your wireless mouse	6
Pairing your wireless mouse	8
Pairing your mouse using the Dell Secure Link USB Receiver	8
Pairing your wireless mouse using Bluetooth	9
Pairing your wireless mouse using Dell Pair	10
Pairing your wireless mouse using Swift Pair	10
Add device	11
Specifications	12
Troubleshooting	13
Statutory Information	17
Warranty	17
Limited warranty and return policies	17
For U.S. customers:	17
For European, Middle Eastern and African customers:.....	17
For non-U.S. customers:	17

What's in the box

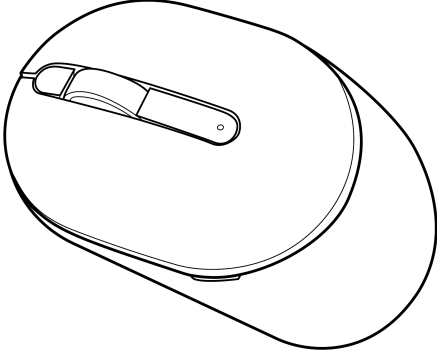
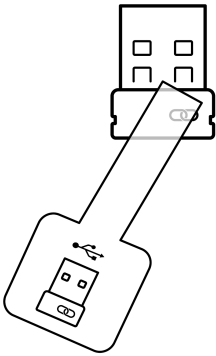
Table 1. Mouse components and descriptions.

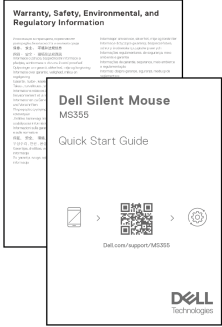
Component image	Component description
	Dell Silent Mouse
	Dell Secure Link USB Receiver
	Battery (AA-type)
	Documents

Features

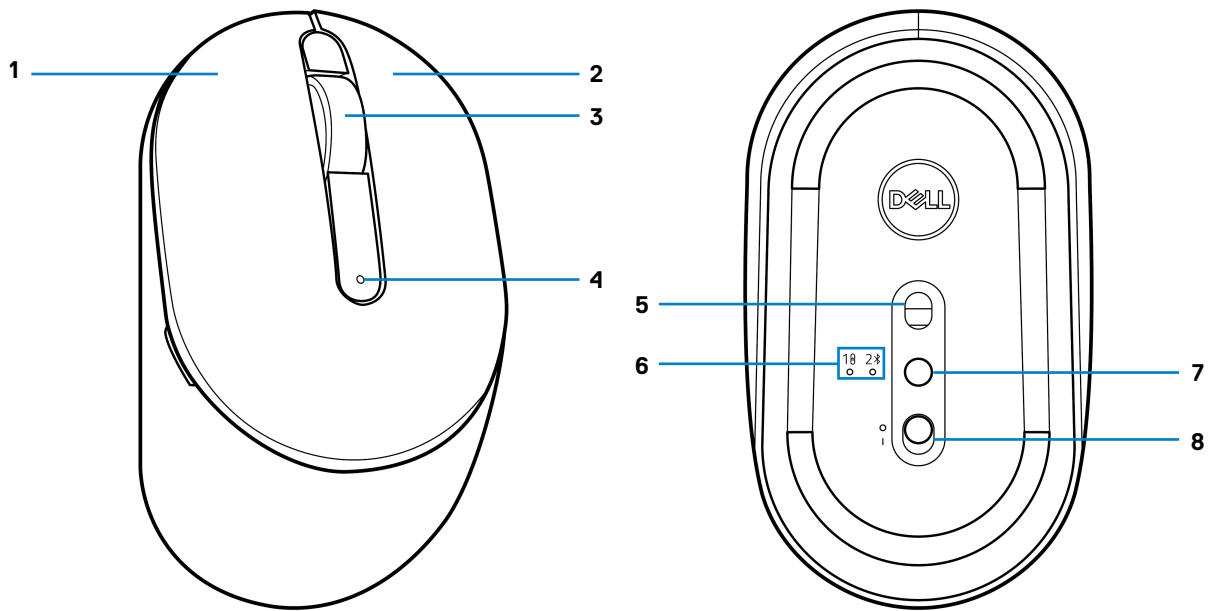

Figure 1. Mouse features

Table 2. Mouse features.

Label	Description
1	Left button
2	Right button
3	Middle button and scroll wheel
4	Low battery LED indicator
5	Optical sensor
6	Connection-mode LED indicators
7	Connection-mode button
8	Power switch

Dell Peripheral Manager

Dell Peripheral Manager software enables you to perform the following:

- Assign program shortcuts to device programmable buttons or keys through the Action tab.
 - Set primary mouse button (left or right) (for mouse only).
 - Adjust mouse sensitivity through DPI setting (for mouse only).
 - Adjust polling rate (for mouse only).
 - View device information such as firmware version and battery status through the Info tab.
 - Upgrade the latest firmware updates on your devices.
 - Pair additional devices through the Dell Secure Link USB Receiver or directly to your computer through Bluetooth.
- For more information, see Dell Peripheral Manager User's Guide on the product page at www.dell.com/support.

Setting up your wireless mouse

1. Locate the slot on the side of the mouse cover. Using your fingertip, lift the mouse cover.

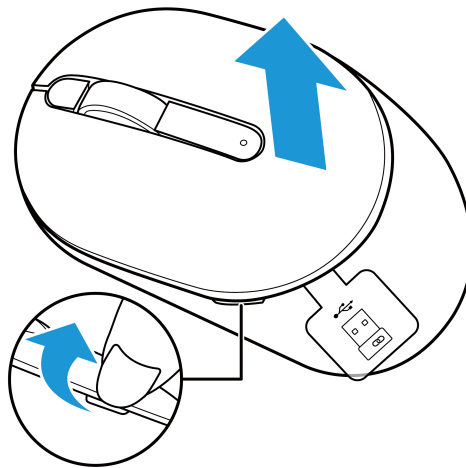

Figure 2. Removing the mouse cover

2. Remove the Dell Secure Link USB Receiver from its compartment.

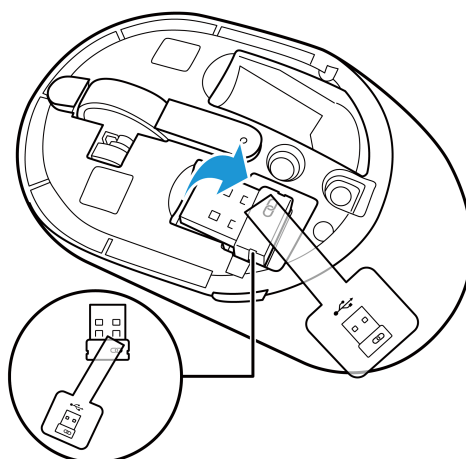

Figure 3. Removing the Dell Secure Link USB Receiver

3. Install the AA battery into the battery compartment.

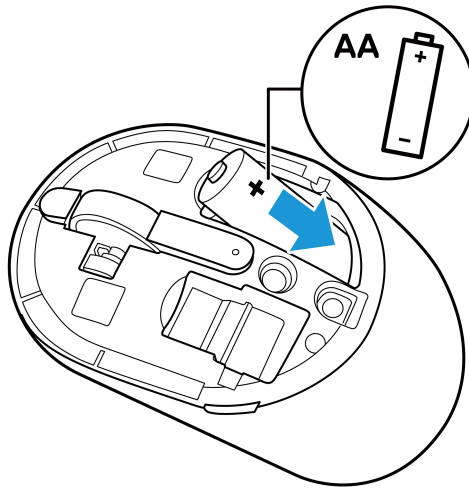

Figure 4. Installing the battery

4. Replace the mouse cover.

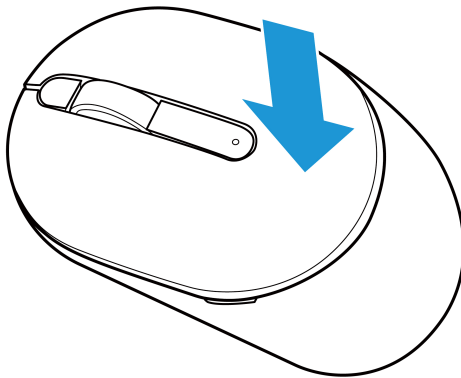

Figure 5. Replacing the mouse cover

5. Slide the power switch to turn on the mouse.

NOTE: Ensure that the distance between your computer and mouse is within ten meters.

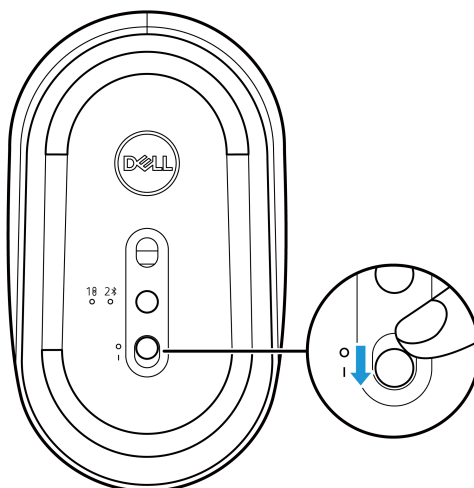

Figure 6. Turning on the mouse

Pairing your wireless mouse

Your Dell wireless mouse can be paired with devices using either the Dell Secure Link USB Receiver or Bluetooth. You can pair and switch between a laptop, desktop, or any compatible mobile device.

Pairing your mouse using the Dell Secure Link USB Receiver

To pair your mouse using the Dell Secure Link USB Receiver, connect the Dell Secure Link USB Receiver to the USB port of your computer.

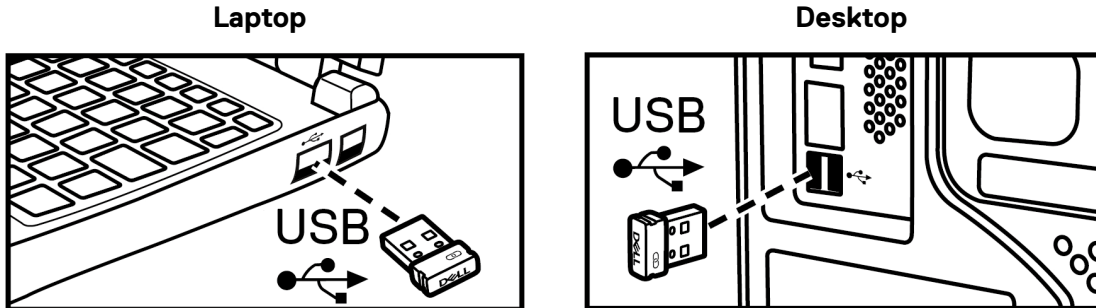

Figure 7. Connecting the Dell Secure Link USB Receiver

The connection-mode LED indicator (1) on the mouse lights up for 30 seconds to indicate the pairing process is in progress, and then turns off.

The mouse is paired with your computer.

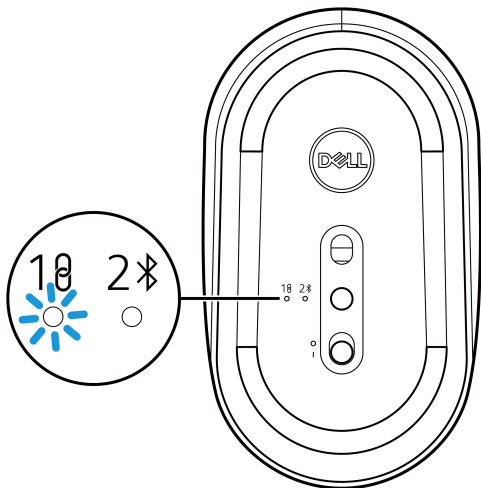

Figure 8. Mouse pairing in progress



Figure 9. The mouse pairing process is completed

NOTE: A USB-C to USB-A adapter (sold separately) is required if your computer does not support USB-A port.

NOTE: The RF device is pre-paired at the factory.

Pairing your wireless mouse using Bluetooth

① **NOTE:** Before pairing your wireless keyboard using Bluetooth, ensure that you update the Bluetooth driver on your Dell computer to the latest version. For more information, see Drivers & Downloads at <https://www.dell.com/support>.

1. Press the connection-mode button to switch to the Bluetooth pairing mode (2 ✂).
2. Press the connection-mode button for 3 seconds. Ensure that the Bluetooth LED (2 ✂) blinks white, indicating that the Bluetooth pairing process has been initiated.

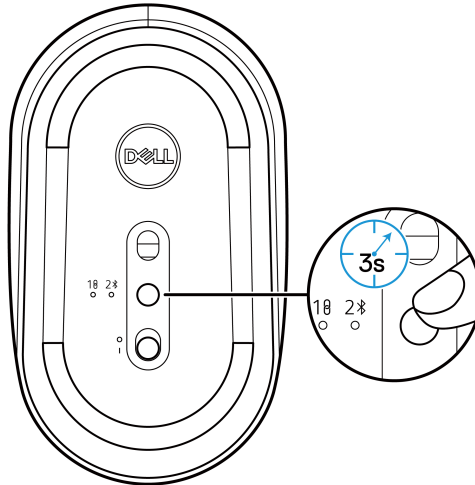

Figure 10. Initiating the Bluetooth pairing mode

The connection-mode LED indicator (2 ✂) blinks for 3 minutes, indicating that your mouse is in the pairing mode.

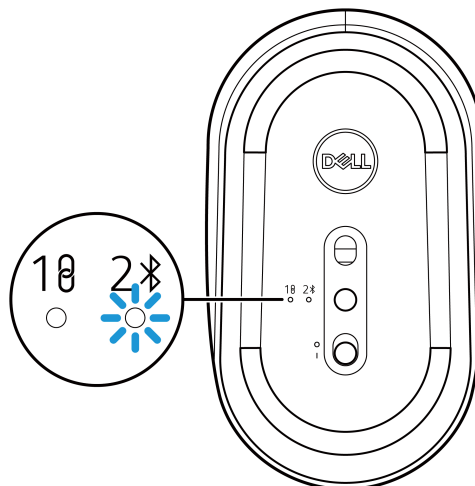



Figure 11. Mouse in the Bluetooth pairing mode

3. Pair your wireless mouse with your Bluetooth-enabled computer.

Pairing your wireless mouse using Dell Pair

NOTE: Dell Pair is available with select accessories, commercial & consumer computers. Availability and functionality vary by model. For more details visit Dell.com/support/kbdoc/000201693.

1. Ensure that Bluetooth of computer is turned on.
2. Place your wireless mouse near your computer. Then press the connection-mode button to switch to the Bluetooth pairing mode (2 )
3. Press the connection-mode button for three seconds. Ensure that the Bluetooth channel LED (2 ) blinks white, indicating the Bluetooth pairing is initiated.
4. The **Let's set up your Dell Keyboard** window appears. Click **Pair**.

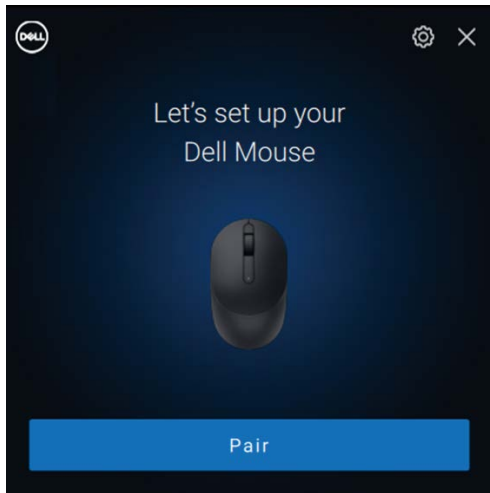

Figure 12-1. Pairing your wireless mouse using Dell Pair

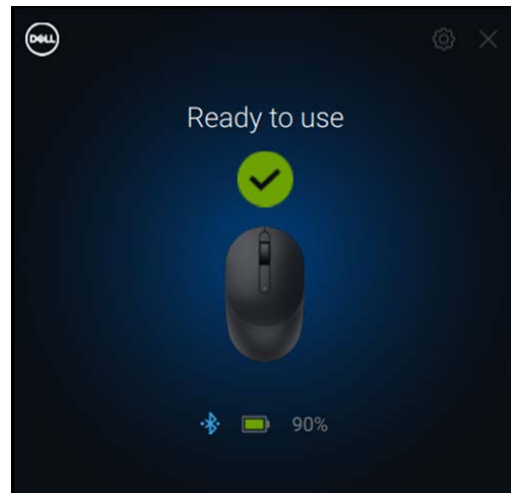

Figure 12-2. Wireless mouse is successfully connected

Pairing your wireless mouse using Swift Pair

1. In Windows Search, type **Bluetooth**.
2. Click **Bluetooth and other devices settings**. The **Settings** window appears.
3. Select the **Show notifications to connect using Swift Pair** check box.

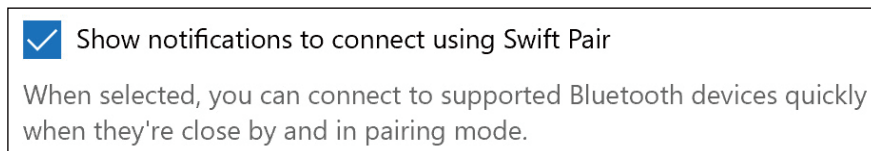



Figure 13. Enable Swift Pair

4. Turn on the Bluetooth.
5. Place your wireless mouse near your computer. Then press the connection-mode button to switch to the Bluetooth pairing mode (2 )
6. Press the connection-mode button for three seconds. Ensure that the Bluetooth channel LED (2 ) blinks white, indicating the Bluetooth pairing is initiated.

The **New Dell MS355 found** window appears.

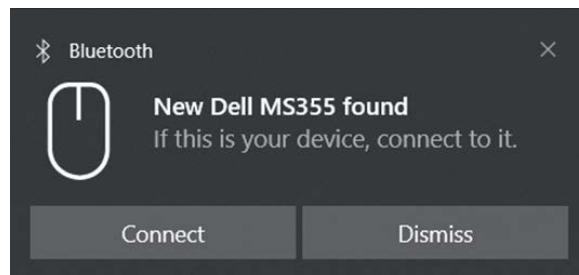

Figure 14. Pairing your wireless mouse using Swift Pair

7. Click **Connect** to confirm the pairing process between the wireless mouse and your computer.

Add device

1. Select **Start > Settings > Devices > Bluetooth & other devices > Add Bluetooth or other device > Bluetooth.**
2. Select **Dell MS355**, and then click **Done**.

NOTE: If Dell MS355 is not listed in your computer, check and ensure that the pairing mode is enabled on the mouse.

3. Confirm the pairing process on both the wireless mouse and your computer.

The Bluetooth LED (2) turns solid white for a few seconds to confirm the pairing, and then the light turns off. After your mouse and computer pairing is completed, the mouse connects to the computer automatically when the Bluetooth is enabled and both devices are within the Bluetooth range.



Figure 15. The mouse pairing process is completed (1 of 2)

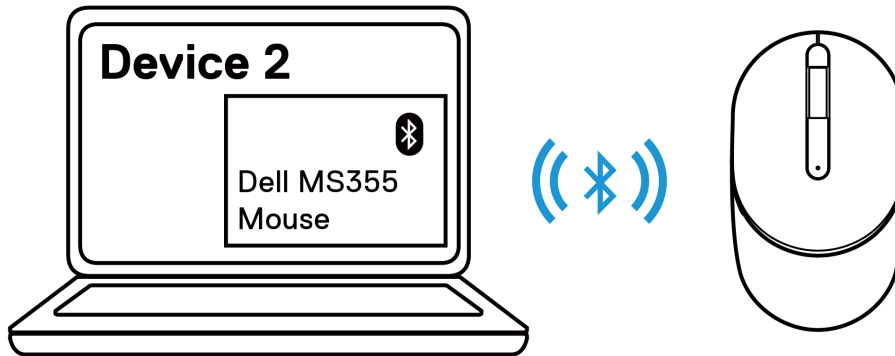

Figure 16. The mouse pairing process is completed (2 of 2)

Specifications

Table 3. Specifications.

Specifications	Value
Model number	MS355
Connection type	Dual Wireless (Bluetooth 5.1 and 2.4 GHz with Dell Secure Link USB Receiver)
System requirement	<ul style="list-style-type: none"> • Windows XP (Dell Secure Link USB Receiver only) • Windows Vista (Dell Secure Link USB Receiver only) • Windows 7, 32/64 bit (Dell Secure Link USB Receiver only) • Windows Server 2003 (Dell Secure Link USB Receiver only) • Windows Server 2008; 2008 R2 (Dell Secure Link USB Receiver only) • Windows Server 2012; 2012 R2, 2016 (Dell Secure Link USB Receiver only) • Windows 8, 32/64 bit, Windows8.1 (Basic function only) • Android • Chrome • iOS, MacOS, iPadOS • Linux (Ubuntu v18.04 LTS, Redhat 8.0+) • Free-DOS (Dell Secure Link USB Receiver only)
Operating voltage	1.6 V ~ 0.9 V
Battery type	One AA alkaline battery
Weight (with battery)	89 g (0.196 lb)
Weight (without battery)	67 g (0.148 lb)
Length	104.46 mm (4.113 in.)
Width	60.28 mm (2.373 in.)
Height	38 mm (1.496 in.)
Operating	-0°C to 40°C (32°F to 104°F)
Storage	-40°C to 65°C (-40°F to 149°F)
Storage humidity	95% maximum relative humidity; non-condensing
RF protocol	<ul style="list-style-type: none"> • Bluetooth 5.1 • 2.4 GHz RF
Range	<ul style="list-style-type: none"> • Up to 10 m radio range. • No performance degradation up to maximum radio range (10 m).

Troubleshooting

Table 4. Troubleshooting.

Problems	Possible solutions
Unable to use the wireless mouse	<ol style="list-style-type: none"> 1. Check if the batteries are inserted in the correct orientation. The battery “+” and “-” ends should be placed as indicated on the battery compartment. 2. Check the battery level. <ul style="list-style-type: none"> • If the wireless mouse uses rechargeable batteries, ensure that the batteries are fully charged. • If the batteries are exhausted, replace them with the new ones. 3. Turn the wireless mouse and then turn it on again. Check if the low battery LED indicator is flashing amber, indicating that the battery power is low. If the battery is fully depleted, the low battery LED indicator will not turn on. 4. Restart your computer. 5. If you are pairing the wireless mouse with the Dell Secure Link USB Receiver, ensure that the Dell Secure Link USB Receiver is directly connected to your computer. <ul style="list-style-type: none"> • Change the USB port. Insert the Dell Secure Link USB Receiver into another USB port on your computer. 6. If you are pairing the mouse using Bluetooth for the first time, see the Pairing your wireless mouse using Bluetooth section for more information. <ul style="list-style-type: none"> • On your computer, turn off the Bluetooth, and then turn it on. • Check for interference that may affect Bluetooth connectivity such as, nearby Wifi and USB 3.0 devices. 7. Ensure that the distance between your computer and mouse is within ten meters
Mouse buttons do not work.	<ol style="list-style-type: none"> 1. Ensure that the battery is fully charged. 2. Turn off the mouse, and then turn it on. 3. On your computer, turn the Bluetooth off and on. 4. Restart your computer. 5. Check for interference that may affect Bluetooth connectivity such as, nearby Wifi and USB 3.0 devices. <ul style="list-style-type: none"> • Check for any wireless devices that are in close proximity such as wireless networking devices (Bluetooth printer and USB 3.0 dongle), wireless pointing devices, and microwave ovens. • Move away from these devices.
Unable to pair the wireless mouse with your computer.	<ol style="list-style-type: none"> 1. Check the battery level. <ul style="list-style-type: none"> • If the wireless mouse/wireless keyboard uses rechargeable batteries, ensure that the batteries are fully charged. • If the batteries are exhausted, replace them with the new ones. 2. Turn the wireless mouse off, and then turn it on. Check if the low battery indicator LED is flashing amber ten times, indicating that the battery power is low. If the battery is fully depleted, the low battery indicator LED will not turn on. 3. Ensure your wireless mouse is with the correct connection mode (RF or Bluetooth). 4. Restart your computer.

Problems	Possible solutions
<p>Unable to pair the wireless mouse with your computer using Bluetooth.</p>	<ol style="list-style-type: none"> 1. Check the battery level. <ul style="list-style-type: none"> • If the wireless mouse uses rechargeable batteries, ensure that the batteries are fully charged. • If the batteries are exhausted, replace them with the new ones. 2. Turn the wireless mouse off, and then turn it on again. Check if the low battery LED indicator is flashing amber, indicating that the battery power is low. If the battery is fully depleted, the low battery LED indicator will not turn on. 3. On your computer, turn the Bluetooth off and on. 4. Restart your computer. Check if you have the latest Bluetooth driver installed on your computer. Go to www.dell.com/support and update the correct Bluetooth driver. For more information, see Download and install the Bluetooth driver. 5. Check the operating system is Windows 11/Windows 10/Windows 8/ Chrome/Android. 6. Ensure that the Bluetooth device is in pairing mode. See Pairing your wireless mouse using Bluetooth in this user guide. 7. Ensure that the wireless mouse is set to Bluetooth Low Energy (BLE) mode in your computer. For more information, see the documentation that came with your computer.
<p>Wireless mouse pointer does not move or left/right buttons do not work</p>	<ol style="list-style-type: none"> 1. Check the battery level. <ul style="list-style-type: none"> • If the wireless mouse uses a rechargeable battery, ensure that the battery is fully charged. • If the battery is exhausted, replace it with a new one. 2. Turn the wireless mouse off, and then turn it on. Check if the battery-status light is flashing amber for ten times, indicating that the battery power is low. If the battery is fully depleted, the battery-status will not turn on. 3. Restart your computer.

Problems	Possible solutions
Wireless connection is lost.	<ol style="list-style-type: none"> 1. Ensure that the Dell Secure Link USB Receiver is connected directly to your computer. 2. Check the battery level. <ul style="list-style-type: none"> • If the wireless mouse uses rechargeable batteries, ensure that the batteries are fully charged. • If the batteries are exhausted, replace them with the new ones. 3. Turn the wireless mouse off, and then turn it on again. Check if the low battery LED indicator is flashing amber for ten times, indicating that the battery power is low. If the battery is fully depleted, the low battery LED indicator will not turn on. 4. On your computer, turn the Bluetooth off and on. 5. Restart your computer. Check if you have the latest Bluetooth driver installed on your computer. Go to www.dell.com/support and update the correct Bluetooth driver. For more information, see Download and install the Bluetooth driver. 6. Check for interference that may affect Bluetooth or Wifi connectivity such as, nearby Wifi and USB 3.0 devices. <ul style="list-style-type: none"> • Check for any wireless devices that are in close proximity such as wireless networking devices (Bluetooth printer and USB 3.0 dongle), wireless pointing devices, and microwave ovens. • Move away from these devices. 7. Ensure that the distance between your laptop, desktop, or a compatible mobile device where the Dell Secure Link USB Receiver is connected is within 1m. 8. Ensure that the USB-A port where the Dell Secure Link USB Receiver is connected is not close to the USB-A port(s) where other devices are connected. 9. If necessary, connect the Dell Secure Link USB Receiver to the dongle extender and check the wireless connection again.
Mouse movement and button clicks are lagging and erratic.	<ol style="list-style-type: none"> 1. Check for interference that may affect Bluetooth or RF connectivity such as, nearby Wifi and USB 3.0 devices. <ul style="list-style-type: none"> • Check for any wireless devices that are in close proximity such as wireless networking devices (Bluetooth printer and USB 3.0 dongle), wireless pointing devices, and microwave ovens. • Move away from these devices. 2. Ensure that the distance between your laptop, desktop, or a compatible mobile device where the Dell Secure Link USB Receiver is connected is within 1m. 3. Ensure that the USB-A port where the Dell Secure Link USB Receiver is connected is not close to the USB-A port(s) where other devices are connected. 4. If necessary, connect the Dell Secure Link USB Receiver to the dongle extender and check the wireless connection again.

Problems	Possible solutions
Solving a slow moving cursor.	<ol style="list-style-type: none">1. Ensure that the sensor is not obstructed or dirty.2. Glass or very smooth glossy surfaces are not suitable for the mouse sensor to capture the mouse movement. Using a dark colored fabric mouse pad can improve the tracking.3. Change the mouse settings to adjust the pointer speed. Click on the tab that matches the Operating System (OS) installed on your laptop/desktop and perform the steps within that section to change the settings.<ol style="list-style-type: none">1. In the Search box, type <code>main.cpl</code>. The Mouse Properties dialog box appears.2. Click or tap <code>main.cpl</code> in the list of programs.3. Click the Pointer Options tab. In the Motion section, move the slider to adjust the pointer speed to the desired level.4. Click or tap OK.

Statutory Information

Warranty

Limited warranty and return policies

Dell-branded products carry a three-year limited hardware warranty. If purchased together with Dell system, it will follow the system warranty.

For U.S. customers:

This purchase and your use of this product are subject to Dell's end user agreement, which you can find at [Dell.com/terms](https://www.dell.com/terms). This document contains a binding arbitration clause.

For European, Middle Eastern and African customers:

Dell-branded products that are sold and used are subject to applicable national consumer legal rights, the terms of any retailer sale agreement that you have entered into (which will apply between you and the retailer) and Dell's end user contract terms.

Dell may also provide an additional hardware warranty – full details of the Dell end user contract and warranty terms can be found by going to [Dell.com/terms](https://www.dell.com/terms), selecting your country from the list at the bottom of the "home" page and then clicking the "terms and conditions" link for the end user terms or the "support" link for the warranty terms.

For non-U.S. customers:

Dell-branded products that are sold and used are subject to applicable national consumer legal rights, the terms of any retailer sale agreement that you have entered into (which will apply between you and the retailer) and Dell's warranty terms. Dell may also provide an additional hardware warranty – full details of Dell's warranty terms can be found by going to [Dell.com](https://www.dell.com), selecting your country from the list at the bottom of the "home" page and then clicking the "terms and conditions" link or the "support" link for the warranty terms.