

Precision 3590

Owner's Manual

Notes, cautions, and warnings

 **NOTE:** A NOTE indicates important information that helps you make better use of your product.

 **CAUTION:** A CAUTION indicates either potential damage to hardware or loss of data and tells you how to avoid the problem.

 **WARNING:** A WARNING indicates a potential for property damage, personal injury, or death.

Chapter 1: Views of Precision 3590	8
Right	8
Left	9
Top	10
Front	11
Back	12
Bottom	12
Service Tag	13
Battery-charge status light	13
Chapter 2: Set up your Precision 3590	14
Chapter 3: Specifications of Precision 3590	16
Dimensions and weight	16
Processor	16
Chipset	18
Operating system	19
Memory	19
External ports and slots	19
Internal slots	20
Ethernet	20
Wireless module	20
WWAN module	21
Audio	22
Storage	23
Media-card reader	23
Keyboard	23
Keyboard function keys	24
Camera	26
Touchpad	26
Power adapter	27
Power adapter requirements of Precision 3590 (option 1)	27
Power adapter requirements of Precision 3590 (option 2)	28
Battery	29
Display	30
Fingerprint reader (optional)	31
Sensor	31
GPU—Integrated	32
GPU—Discrete	32
External display support	32
Hardware security	32
Smart-card reader	33
Contactless smart-card reader	33
Contacted smart-card reader	36

Operating and storage environment.....	37
Dell support policy.....	37
ComfortView Plus.....	37
Using the privacy shutter.....	38
Dell Optimizer.....	38
Chapter 4: Working inside your computer.....	40
Safety instructions.....	40
Before working inside your computer.....	40
Safety precautions.....	41
Electrostatic discharge—ESD protection.....	41
ESD Field Service kit	42
Transporting sensitive components.....	43
After working inside your computer.....	43
BitLocker.....	43
Recommended tools.....	43
Screw list.....	44
Major components of Precision 3590.....	45
Chapter 5: Removing and installing Customer Replaceable Units (CRUs).....	48
SIM card tray.....	48
Removing the SIM card tray (optional).....	48
Installing the SIM card tray (optional).....	49
Base cover.....	50
Removing the base cover.....	50
Installing the base cover.....	53
Wireless card.....	55
Removing the wireless card.....	55
Installing the wireless card.....	56
Wireless Wide Area Network (WWAN) card.....	58
Removing the 4G WWAN card.....	58
Installing the 4G WWAN card.....	60
Removing the 5G WWAN card.....	61
Installing the 5G WWAN card.....	63
Memory module.....	64
Removing the memory module.....	64
Installing the memory module.....	65
Solid State Drive (SSD).....	66
Removing the M.2 2230 SSD from slot 1 (SSD1).....	66
Installing the M.2 2230 SSD in slot 1 (SSD1).....	67
Removing the M.2 2280 SSD from slot 1 (SSD1).....	68
Installing the M.2 2280 SSD in slot 1 (SSD1).....	69
Removing the M.2 2230 SSD from slot 2 (SSD2).....	70
Installing the M.2 2230 SSD in slot 2 (SSD2).....	71
Fan.....	72
Removing the fan.....	72
Installing the fan.....	73
Chapter 6: Removing and installing Field Replaceable Units (FRUs).....	75

Battery.....	75
Rechargeable Li-ion battery precautions.....	75
Removing the battery.....	75
Installing the battery.....	77
Assembly-inner frame.....	78
Removing the assembly-inner frame.....	78
Installing the assembly-inner frame.....	80
Touchpad.....	82
Removing the touchpad.....	82
Installing the touchpad.....	83
Speakers.....	84
Removing the speakers.....	84
Installing the speakers.....	85
Coin-cell battery.....	87
Removing the coin-cell battery.....	87
Installing the coin-cell battery.....	87
Heat sink.....	88
Removing the heat sink (Discrete GPU).....	88
Installing the heat sink (Discrete GPU).....	89
Removing the heat sink (Integrated GPU).....	90
Installing the heat sink (Integrated GPU).....	91
System board.....	92
Removing the system board.....	92
Installing the system board.....	96
Power button.....	99
Removing the power button.....	99
Installing the power button.....	100
Power button with optional fingerprint reader.....	101
Removing the power button with an optional fingerprint reader.....	101
Installing the power button with an optional fingerprint reader.....	102
Keyboard.....	103
Removing the keyboard.....	103
Installing the keyboard.....	105
Display assembly.....	107
Removing the display assembly.....	107
Installing the display assembly.....	110
Display bezel.....	113
Removing the display bezel.....	113
Installing the display bezel.....	114
Display panel.....	115
Removing the display panel.....	115
Installing the display panel.....	118
Camera module.....	121
Removing the camera module.....	121
Installing the camera module.....	122
Display hinges.....	124
Removing the display hinges.....	124
Installing the display hinges.....	124
Display back cover.....	125
Removing the display back cover.....	125

Installing the display back cover.....	126
Display cable.....	127
Removing the display cable.....	127
Installing the display cable.....	128
Sensor board.....	129
Removing the sensor board.....	129
Installing the sensor board.....	130
Fingerprint reader (optional).....	131
Removing the fingerprint reader (optional).....	131
Installing the fingerprint reader (optional).....	132
Smart-card reader.....	134
Removing the smart-card reader.....	134
Installing the smart-card reader.....	135
Dummy SIM-card slot filler.....	136
Removing the dummy SIM-card slot filler.....	136
Installing the dummy SIM-card slot filler.....	137
Palm-rest assembly.....	138
Removing the palm-rest assembly.....	138
Installing the palm-rest assembly.....	140
Chapter 7: Software.....	142
Operating system.....	142
Drivers and downloads.....	142
Chapter 8: BIOS Setup.....	143
Entering BIOS Setup program.....	143
Navigation keys.....	143
F12 One Time Boot menu.....	143
View Advanced Setup options.....	144
View Service options.....	144
System Setup options.....	144
Updating the BIOS.....	165
Updating the BIOS in Windows.....	165
Updating the BIOS in Linux and Ubuntu.....	166
Updating the BIOS using the USB drive in Windows.....	166
Updating the BIOS from the One-Time boot menu.....	166
System and setup password.....	167
Assigning a System Setup password.....	167
Deleting or changing an existing system password or setup password.....	168
Clearing CMOS settings.....	168
Clearing BIOS (System Setup) and System passwords.....	169
Chapter 9: Troubleshooting.....	170
Handling swollen rechargeable Li-ion batteries.....	170
Locating the Service Tag or Express Service Code of your Dell computer	170
Dell SupportAssist Pre-boot System Performance Check diagnostics.....	171
Running the SupportAssist Pre-Boot System Performance Check.....	171
Built-in self-test (BIST).....	171
M-BIST.....	171

LCD Power rail test (L-BIST).....	172
LCD Built-in Self-Test (BIST).....	172
System-diagnostic lights.....	173
Recovering the operating system.....	174
Real-Time Clock (RTC Reset).....	174
Backup media and recovery options.....	175
Wi-Fi power cycle.....	175
Drain residual flea power (perform hard reset).....	175
Chapter 10: Getting help and contacting Dell.....	176

Views of Precision 3590

Right

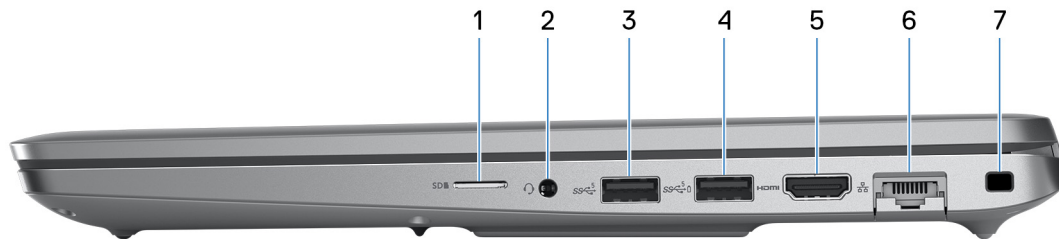

Figure 1. Right view

1. microSD-card slot

Reads from and writes to the microSD-card.

2. Universal audio jack

Connect headphones or a headset (headphone and microphone combo).

3. USB 3.2 Gen 1 port

Connect devices such as external storage devices and printers. It provides data transfer speeds up to 5 Gbps.

4. USB 3.2 Gen 1 port with PowerShare

Connect devices such as external storage devices and printers.

It provides data transfer speeds up to 5 Gbps. PowerShare enables you to charge your USB devices even when your computer is turned off.

NOTE: If your computer is turned off or in a hibernate state, you must connect the power adapter to charge your devices using the PowerShare port. You must enable this feature in the BIOS setup program.

NOTE: Certain USB devices may not charge when the computer is turned off or in a sleep state. In such cases, turn on the computer to charge the device.

5. HDMI 2.1 TMDs port

Connect to a TV, external display, or another HDMI-in enabled device. Provides video and audio output.

6. Network port

Connect an Ethernet (RJ45) cable from a router or a broadband modem for network or Internet access, with a transfer rate of 10/100/1000 Mbps.

7. Security-cable slot (wedge-shaped)

Connect a security cable to prevent unauthorized movement of your computer.

Left

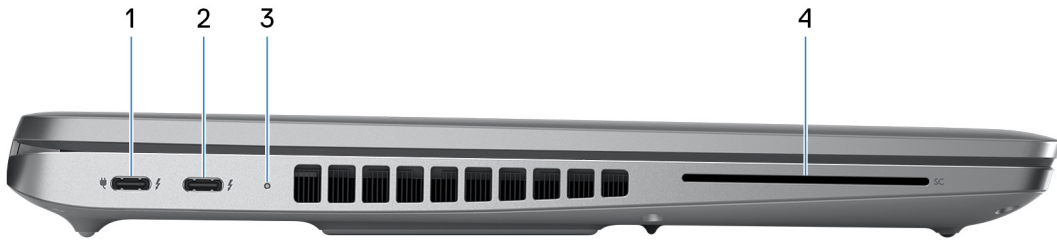

Figure 2. Left view

1. Thunderbolt 4.0 with DisplayPort Alt Mode/USB Type-C/USB4/Power Delivery

Supports USB4, DisplayPort 2.1, Thunderbolt 4 and also enables you to connect to an external display using a display adapter. Provides data transfer rates of up to 40 Gbps for USB4 and Thunderbolt 4.

NOTE: You can connect a Dell Docking Station to one of the Thunderbolt 4 ports. For more information, search in the Knowledge Base Resource at [Dell Support Site](#).

NOTE: A USB Type-C to DisplayPort adapter (sold separately) is required to connect a DisplayPort device.

NOTE: USB4 is backward compatible with USB 3.2, USB 2.0, and Thunderbolt 3.

NOTE: Thunderbolt 4 supports two 4K displays or one 8K display.

2. Thunderbolt 4.0 with DisplayPort Alt Mode/USB Type-C/USB4/Power Delivery

Supports USB4, DisplayPort 2.1, Thunderbolt 4 and also enables you to connect to an external display using a display adapter. Provides data transfer rates of up to 40 Gbps for USB4 and Thunderbolt 4.

NOTE: You can connect a Dell Docking Station to one of the Thunderbolt 4 ports. For more information, search in the Knowledge Base Resource at [Dell Support Site](#).

NOTE: A USB Type-C to DisplayPort adapter (sold separately) is required to connect a DisplayPort device.

NOTE: USB4 is backward compatible with USB 3.2, USB 2.0, and Thunderbolt 3.

NOTE: Thunderbolt 4 supports two 4K displays or one 8K display.

3. Battery-status light

Battery-status light indicates the battery-charge status.

- White-Battery is charging.
- Solid yellow-Battery charge is low.
- Blinking yellow-Battery charge is critical.
- Off—Battery is fully charged.

4. Smart-card reader slot (optional)

Using smart card provides authentication in corporate networks.

Top

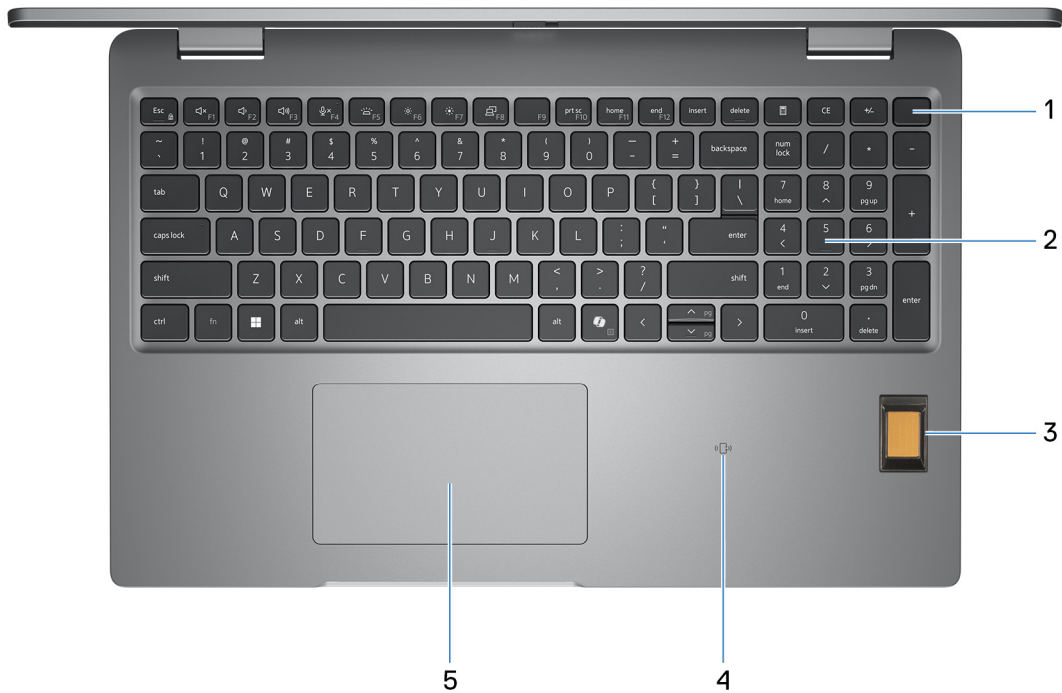

Figure 3. Image: Top view

1. Power button with optional fingerprint reader

Press to turn on the computer if it is turned off, in sleep state, or in hibernate state.

When the computer is turned on, press the power button to put the computer into sleep state; press and hold the power button to force shut-down the computer.

If the power button has a fingerprint reader, place your finger on the power button steadily to log in.

NOTE: You can customize the power-button behavior in Windows.

2. Keyboard

Use the keyboard to input characters and functions into your computer.

3. Fingerprint reader (optional)

Press your finger on the fingerprint reader to log in to your computer. The fingerprint reader enables your computer to recognize your fingerprints as a password.

NOTE: Configure the fingerprint reader to register your fingerprint and enable access.

4. NFC or Contactless smart card reader (optional)

NFC or Contactless smart card reader provides contactless access of cards in corporate networks.

5. Touchpad

Move your finger on the touchpad to move the mouse pointer. Tap to left-click and two fingers tap to right-click.

Front



Figure 4. Image: Front view

1. Left microphone

Provides digital sound input for audio recording and voice calls.

2. Infrared emitter (optional)

The infrared emitter emits infrared light, which enables the infrared camera to sense and track motion.

3. Infrared camera (optional)

Enhances security when paired with Windows Hello face authentication.

4. Camera shutter

Slide the privacy shutter to the left to access the camera lens.

5. Camera

A camera enables you to video chat, capture photos, and record videos.

6. Camera-status light

Turns on when the camera is in use.

7. Ambient-light sensor (optional)

The sensor detects the ambient light and automatically adjusts the display brightness.

8. Right microphone

Provides digital sound input for audio recording and voice calls.

Back



Figure 5. Image: Back view

1. Nano-SIM card slot (optional)

Insert a nano-SIM card to connect to a mobile broadband network.

NOTE: Availability of the nano-SIM card slot depends on the region and configuration ordered.

Bottom

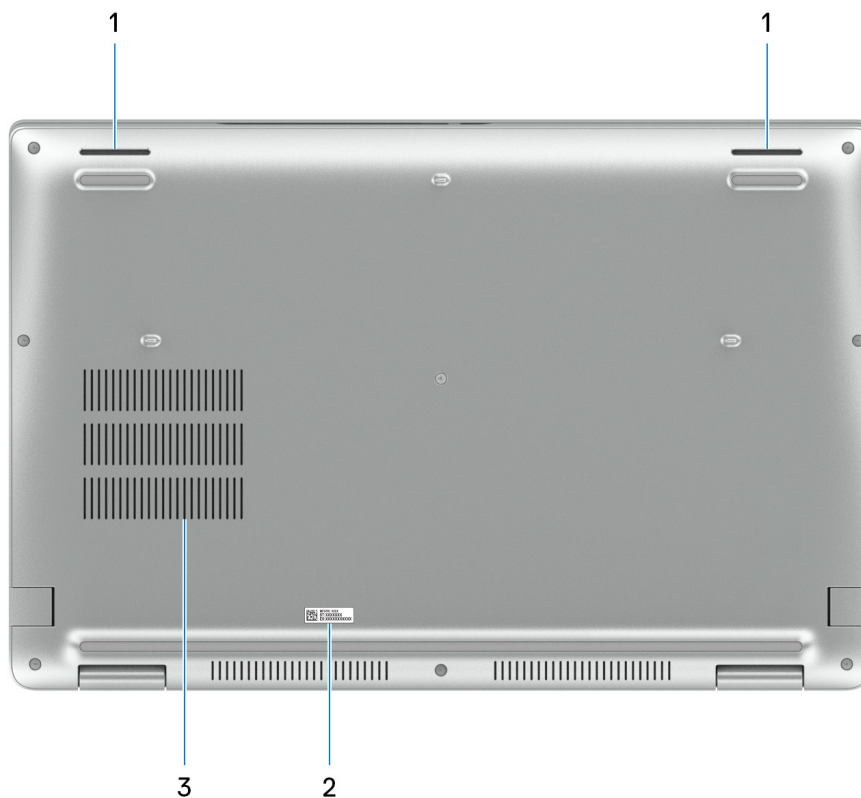

Figure 6. Image: Bottom view

1. Speakers

Provide audio output.

2. Service Tag label

The Service Tag is a unique alphanumeric identifier that enables Dell service technicians to identify the hardware components in your computer and access warranty information.

3. Air vents

Air vents provide ventilation for your computer. Clogged air vents can cause overheating and can affect your computer's performance and potentially cause hardware issues. Keep the air vents clear of obstructions and clean them regularly to prevent the build-up of dust and dirt. For more information about cleaning air vents, search for articles in the Knowledge Base Resource at [Dell Support Site](#).

Service Tag

The service tag is a unique alphanumeric identifier that allows Dell service technicians to identify the hardware components in your computer and access warranty information.

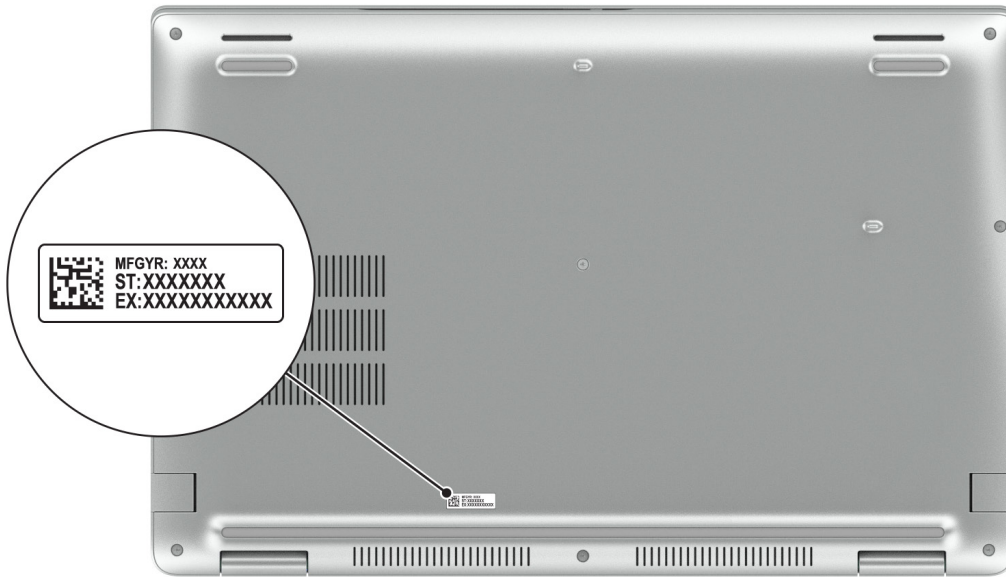

Figure 7. Image: Service Tag location

Battery-charge status light

The following table lists the battery-charge status light of your Precision 3590.

Table 1. Battery charge and status light behavior

Power source	LED behavior	System power state	Battery charge level
AC adapter	Off	S0 or S5	Fully charged
AC adapter	Solid white	S0 or S5	< Fully charged
Battery	Off	S0 or S5	11-100%
Battery	Solid amber (590+/-3 nm)	S0 or S5	< 10%

- S0 (ON): Computer is turned on.
- S4 (Hibernate): The computer consumes the least power in the Hibernate state than in the ON or OFF state. The computer is almost in the OFF state. The context data is written to a storage device, allowing you to resume from where you left when the computer is turned on.
- S5 (OFF): The computer is in a shutdown state.

Set up your Precision 3590

About this task

NOTE: The images in this document may differ from your computer depending on the configuration you ordered.

Steps

1. Connect the power adapter and press the power button.



Figure 8. Connect power adapter and press the power button

NOTE: The battery may go into power-saving mode during shipment to conserve charge on the battery. Ensure that the power adapter is connected to your computer when it is turned on for the first time.

2. Finish the operating system setup.

For Ubuntu:

Follow the on-screen instructions to complete the setup. For more information about installing and configuring Ubuntu, search in the Knowledge Base Resource at [Dell Support Site](#).

For Windows:

Follow the on-screen instructions to complete the setup. When setting up, Dell Technologies recommends that you:





- Connect to a network for Windows updates.

NOTE: If connecting to a secured wireless network, enter the password for the wireless network access when prompted.

- If connected to the Internet, sign-in with or create a Microsoft account.

3. Locate and use Dell apps from the Windows Start menu—Recommended.

Table 2. Locate Dell apps

Resources	Description
	<p>Dell Product Registration Register your computer with Dell.</p>
	<p>Dell Help & Support Access help and support for your computer.</p>
	<p>SupportAssist SupportAssist is the smart technology that keeps your computer running at its best by optimizing settings, detecting issues, removing viruses and notifies when you must make computer updates. SupportAssist proactively checks the health of your computer hardware and software. When an issue is detected, the necessary system state information is sent to Dell to begin troubleshooting. SupportAssist is preinstalled on most of the Dell devices running the Windows operating system. For more information, see <i>SupportAssist for Business PCs manuals</i> at Support Assist for Business PCs.</p> <p>NOTE: In SupportAssist, click the warranty expiry date to renew or upgrade your warranty.</p>
	<p>Dell Update Updates your computer with critical fixes and latest device drivers as they become available. For more information about using Dell Update, see the product guides and third-party license documents at Dell Support Site.</p>
	<p>Dell Digital Delivery Download software applications, which are purchased but not preinstalled on your computer. For more information about using Dell Digital Delivery, search in the Knowledge Base Resource at Dell Support Site.</p>

Specifications of Precision 3590

Dimensions and weight

The following table lists the height, width, depth, and weight of your Precision 3590.

Table 3. Dimensions and weight

Description	Values
Height:	
Front height	20.80 mm (0.82 in.)
Rear height	22.80 mm (0.90 in.)
Width	357.80 mm (14.09 in.)
Depth	233.30 mm (9.19 in.)
Weight  NOTE: The weight of your computer depends on the configuration that is offered.	1.62 kg (3.58 lb) - minimum

Processor

The following table lists the details of the processors that are supported for your Precision 3590.

Table 4. Processor

Description	Option one	Option two	Option three
Processor type	Intel Core Ultra 5 125U vPro Essentials	Intel Core Ultra 7 155U vPro Essentials	Intel Core Ultra 5 125H vPro Essentials
Processor wattage	15 W	15 W	28 W
Processor total core count	12	12	14
Performance-cores	2	2	4
Efficient-cores	<ul style="list-style-type: none"> E-cores: 8 LPE-cores: 2 	<ul style="list-style-type: none"> E-cores: 8 LPE-cores: 2 	<ul style="list-style-type: none"> E-cores: 8 LPE-cores: 2
Processor total thread counts <i>i</i> NOTE: Intel Hyper-Threading Technology is only available on Performance-cores.	14	14	18
Processor speed	Up to 4.30 GHz	Up to 4.80 GHz	Up to 4.50 GHz
Performance-cores frequency			
Processor base frequency	1.30 GHz	1.70 GHz	1.20 GHz
Maximum turbo frequency	4.30 GHz	4.80 GHz	4.50 GHz
Efficient-cores frequency			
Processor base frequency	800 MHz	1.20	700 MHz
Maximum turbo frequency	3.60 GHz	3.80 GHz	3.60 GHz
Processor cache	12 MB	12 MB	18 MB
Integrated graphics	Intel Graphics	Intel Graphics	Intel Graphics or Intel Arc Graphics

Table 5. Processor

Description	Option four	Option five	Option six
Processor type	Intel Core Ultra 5 135H vPro Enterprise	Intel Core Ultra 7 155H vPro Essentials	Intel Core Ultra 7 165H vPro Enterprise
Processor wattage	28 W	28 W	28 W
Processor total core count	14	16	16
Performance-cores	4	6	6
Efficient-cores	<ul style="list-style-type: none"> E-cores: 8 LPE-cores: 2 	<ul style="list-style-type: none"> E-cores: 8 LPE-cores: 2 	<ul style="list-style-type: none"> E-cores: 8 LPE-cores: 2
Processor total thread counts <i>i</i> NOTE: Intel Hyper-Threading Technology is only available on Performance-cores.	18	22	22
Processor speed	Up to 4.60 GHz	Up to 4.80 GHz	Up to 5 GHz
Performance-cores frequency			
Processor base frequency	1.70 GHz	1.40 GHz	1.40 GHz
Maximum turbo frequency	4.60 GHz	4.80 GHz	5 GHz
Efficient-cores frequency			
Processor base frequency	1.20 GHz	900 MHz	900 MHz
Maximum turbo frequency	3.60 GHz	3.80 GHz	3.80 GHz
Processor cache	18 MB	24 MB	24 MB
Integrated graphics	Intel Graphics or Intel Arc Graphics	Intel Graphics or Intel Arc Graphics	Intel Graphics or Intel Arc Graphics

Chipset

The following table lists the details of the chipset that is supported in your Precision 3590.

Table 6. Chipset

Description	Values
Chipset	Integrated in the processor
Processor	Intel Core Ultra 5/7
DRAM bus width	64-bit
Flash EPROM	64 MB
PCIe bus	Up to Gen4

Operating system

Your Precision 3590 supports the following operating systems:

- Windows 11 Home
- Windows 11 Pro
- Ubuntu Linux 22.04 LTS

Memory

The following table lists the memory specifications that are supported by your Precision 3590.

Table 7. Memory specifications

Description	Values
Memory slots	Two-SODIMM slots
Memory type	DDR5
Memory speed	5600 MT/s
Maximum memory configuration	64 GB
Minimum memory configuration	8 GB
Memory size per slot	8 GB, 16 GB, or 32 GB
Memory configurations supported	<ul style="list-style-type: none">• 1 x 8 GB, DDR5, 5600 MT/s, single-channel• 1 x 16 GB, DDR5, 5600 MT/s, single-channel• 2 x 8 GB, DDR5, 5600 MT/s, dual-channel• 2 x 16 GB, DDR5, 5600 MT/s, dual-channel• 1 x 32 GB, DDR5, 5600 MT/s, single-channel• 2 x 32 GB, DDR5, 5600 MT/s, dual-channel

External ports and slots

The following table lists the external ports and slots of your Precision 3590.

Table 8. External ports and slots

Description	Values
Network port	One RJ45 port
USB ports	<ul style="list-style-type: none">• One USB 3.2 Gen 1 port• One USB 3.2 Gen 1 port with PowerShare• Two Thunderbolt 4 ports with Power Delivery and DisplayPort <p>NOTE: You can connect a Dell Docking Station to this port. For more information, search in the Knowledge Base Resource at Dell Support Site.</p>
Audio port	One Universal audio port
Video port(s)	One HDMI 2.1 TMDS port

Table 8. External ports and slots (continued)

Description	Values
Media-card reader	One microSD-card slot
Power-adaptor port	Supported through the Thunderbolt 4 ports available on your computer
Security-cable slot	One wedge-shaped lock slot
SIM-card slot	nano-SIM card slot (optional)

Internal slots

The following table lists the internal slots of your Precision 3590.

Table 9. Internal slots

Description	Values
M.2	<ul style="list-style-type: none"> One M.2 2230 slot for WiFi and Bluetooth combo card One M.2 2230 or 2280 slot for solid state drive One M.2 2230 slot for solid-state drive One M.2 3042 slot for WWAN card <p>NOTE: To learn more about the features of different types of M.2 cards, search in the Knowledge Base Resource at Dell Support Site.</p>

Ethernet

The following table lists the wired Ethernet Local Area Network (LAN) specifications of your Precision 3590.

Table 10. Ethernet specifications

Description	Values
Model	Intel I219-LM 10/100/Gb (1000BASE-T) for vPRO configurations
Transfer rate	10/100/1000 Mbps

Wireless module

The following table lists the Wireless Local Area Network (WLAN) modules that are supported on your Precision 3590.

Table 11. Wireless module specifications

Description	Option one	Option two
Model number	Realtek RTL8852BE	Intel AX211
Transfer rate	Up to 1201 Mbps	Up to 2400 Mbps
Frequency bands supported	2.4 GHz/5 GHz	2.4 GHz/5 GHz/6 GHz
Wireless standards	<ul style="list-style-type: none"> WiFi 802.11a/b/g 	<ul style="list-style-type: none"> WiFi 802.11a/b/g

Table 11. Wireless module specifications (continued)

Description	Option one	Option two
	<ul style="list-style-type: none"> • Wi-Fi 4 (WiFi 802.11n) • Wi-Fi 5 (WiFi 802.11ac) • Wi-Fi 6 (WiFi 802.11ax) 	<ul style="list-style-type: none"> • Wi-Fi 4 (WiFi 802.11n) • Wi-Fi 5 (WiFi 802.11ac) • Wi-Fi 6E (WiFi 802.11ax) <p>NOTE: Wi-Fi 6 is supported in regions where Wi-Fi 6E is unavailable.</p>
Encryption	<ul style="list-style-type: none"> • 64-bit/128-bit WEP • AES-CCMP • TKIP 	<ul style="list-style-type: none"> • 64-bit/128-bit WEP • AES-CCMP • TKIP
Bluetooth wireless card	Bluetooth 5.3	Bluetooth 5.3
	<p>NOTE: The functionality of the Bluetooth wireless card may vary depending on the operating system that is installed on your computer.</p>	

WWAN module

The following table lists the Wireless Wide Area Network (WWAN) modules that are supported in your Precision 3590.

NOTE: The WWAN module is available only on certain configurations and in certain regions.

NOTE: Availability of the eSIM feature on this module depends on your region.

NOTE: For instructions on how to setup SIM or eSIM connections on your computer, see the *SIM/eSIM Setup Guide for Windows* available with your product documentation at [Dell Support Site](#).

Table 12. WWAN module specifications

Description	Option one	Option two
Model number	Qualcomm Snapdragon SDX12 Advanced (DW5825e), CAT 12	Qualcomm Snapdragon X62 Global 5G Modem (DW5932e)
Form factor	M.2 3042 Key-B	M.2 3042 Key-B
Host interface	USB 3.0/2.0	PCIe Gen3
Network standard	LTE FDD/TDD, WCDMA/HSPA+, GNSS/Beidou, GPS/GLONASS/Beidou/Galileo	NR FR1 (Sub6) FDD/TDD, LTE FDD/TDD, WCDMA/HSPA+, GPS/GLONASS/Galileo/Beidou
Transfer data rate	<ul style="list-style-type: none"> • Up to 600 Mbps DL (CAT 12) • Up to 150 Mbps UL 	<ul style="list-style-type: none"> • 5G NR: DL 3.5 Gbps/ UL 900 Mbps • LTE: DL 1.6 Gbps (CAT19)/ UL 211 Mbps (CAT18) • UMTS: DL DC-HSPA+ Rel8:42 Mbps / UL 5.76 Mbps
Operating frequency bands	<ul style="list-style-type: none"> • LTE (B1, B2, B3, B4, B5, B7, B8, B12, B13, B14, B17, B18, B19, B20, B25, B26, B28, B29, B30, B32, B38, B39, B40, B41, B42, B43, B48, B66, B71) • HSPA+ (1,2,4,5,6,8,19) 	<ul style="list-style-type: none"> • NR (n1, n2, n3, n5, n7, n8, n20, n25, n28, n30, n38, n40, n41, n48, n66, n71, n77, n78, n79) • LTE (B1, B2, B3, B4, B5, B7, B8, B12, B13, B14, B17, B18, B19, B20, B25, B26, B28, B29, B30, B32, B34, B38,

Table 12. WWAN module specifications (continued)

Description	Option one	Option two
		B39, B40, B41, B42, B43, B46, B48, B66, B71*) <ul style="list-style-type: none"> WCDMA/HSPA+ (1, 2, 4, 5, 8) *Modem hardware supports but currently disabled
Power supply	DC 3.135 V to 4.40 V, Typical 3.30 V	DC 3.135 V to 3.63 V, Typical 3.3 V
SIM card	Supported through external SIM slot	Supported through external SIM slot
eSIM with dual SIM (DSSA)	Supported ⓘ NOTE: The availability of eSIM functionality embedded on the module is dependent on the region and specific carrier requirements.	Supported ⓘ NOTE: The availability of eSIM functionality embedded on the module is dependent on the region and specific carrier requirements.
Antenna diversity	Supported	Supported
Radio on/off	Supported	Supported
Wake on wireless	Supported	Supported
Temperature	<ul style="list-style-type: none"> Normal operating temperature: -10°C to +55°C Extended Operating temperature: -30°C to +75°C 	<ul style="list-style-type: none"> Normal operating temperature: -10°C to +55°C Extended Operating temperature: -30°C to +75°C Storage temperature: -40°C to +85°C
Antenna connector	<ul style="list-style-type: none"> WWAN main antenna x 1 WWAN diversity antenna x 1 	<ul style="list-style-type: none"> WWAN main antenna x 1 WWAN diversity antenna x 1 4x4 MIMO antenna x 2
ⓘ NOTE: For instructions to find your computer's International Mobile Equipment Identity (IMEI) number, search in the Knowledge Base Resource at Dell Support Site .		

Audio

The following table lists the audio specifications of your Precision 3590.

Table 13. Audio specifications

Description	Values
Audio controller	Realtek Waves, MaxxAudio 13.0
Stereo conversion	Supported
Internal audio interface	High definition audio interface
External audio interface	Universal Audio Jack/HDMI 2.1 TMDS port
Number of speakers	2
Internal-speaker amplifier	Not supported
External volume controls	Keyboard shortcut controls

Table 13. Audio specifications (continued)

Description		Values
Speaker output:		
	Average	2 W
	Peak	2 W
Microphone		Digital-array microphones in camera assembly

Storage

This section lists the storage options on your Precision 3590.

Your Precision 3590 supports one of the following storage configurations:

- One M.2 2230 or 2280 solid state drive
- One M.2 2230 solid state drive

Table 14. Storage specifications

Storage type	Interface type	Capacity
M.2 2230 or 2280 solid state drive	PCIe Gen4 NVMe, up to 64 Gbps	Up to 2 TB
M.2 2230 solid state drive	PCIe Gen4 NVMe, up to 64 Gbps	Up to 1 TB
M.2 2230 solid state drive self-encrypting drive	PCIe Gen4 NVMe, up to 64 Gbps	512 GB

Media-card reader

The following table provides the specification of media cards supported by your Precision 3590.

Table 15. Media-card reader specifications

Description	Values
Media-card slot type	One micro-SD card slot
Media-cards supported	<ul style="list-style-type: none"> • microSecure Digital (mSD) • microSecure Digital High Capacity (mSDHC) • microSecure Digital Extended Capacity (mSDXC)
<p> NOTE: The maximum capacity that is supported by the media-card reader varies depending on the standard of the media card that is installed on your computer.</p>	



Keyboard

The following table lists the keyboard specifications of your Precision 3590.

Table 16. Keyboard specifications

Description	Values
Keyboard type	<ul style="list-style-type: none"> • Standard backlit AI hotkey keyboard • Standard non-backlit AI hotkey keyboard

Table 16. Keyboard specifications (continued)

Description	Values
	<p> NOTE: Copilot in Windows is available only in approved markets.</p>
Keyboard layout	QWERTY
Number of keys	<ul style="list-style-type: none"> • English US, English International, English UK, Canada (Bilingual), Arabic, Chinese (Traditional), French (Canadian), Greek, Hebrew, Korean, Russian, Thai, Ukrainian: 99 keys • Bulgarian, English UK, French (Canadian), Spanish (Latin America), Brazilian, Belgian, Czech/Slovak (MUI), Danish, Estonian, French (European), German, Hungarian, Italian, Nordic (MUI), Norwegian, Portugese Iberian, Slovenian, Spanish (Castilian), Spanish (Latin America), Swedish/Finnish, Swiss/European (MUI), Turkish, Turkish (F): 100 keys • Japanese - 103 keys
Keyboard size	<p>X=18.05 mm key pitch</p> <p>Y=18.05 mm key pitch</p>
Keyboard shortcuts	<p>Some keys on your keyboard have two symbols on them. These keys can be used to type alternate characters or to perform secondary functions. To type the alternate character, press Shift and the desired key. To perform secondary functions, press Fn and the desired key.</p> <p> NOTE: You can define the primary behavior of the function keys (F1–F12) changing Function Key Behavior in the BIOS setup program.</p> <p> NOTE: If Copilot in Windows is not available on your computer, pressing the Copilot key launches Windows search. For more information about Copilot in Windows, search in the Knowledge Base Resource at the Dell Support site.</p>

Keyboard function keys

The **F1-F12** keys at the top of the keyboard are function keys. By default, these keys are used to perform specific functions defined by the software application in use.

Table 17. List of keyboard shortcuts



Key	Primary behavior
F1	Mute audio
F2	Decrease volume
F3	Increase volume
F4	Mute microphone
F5	<p>Keyboard backlight</p> <p> NOTE: Toggle to cycle the keyboard backlight status through off, low-backlight, and high-backlight.</p>
F6	Decrease brightness

Table 17. List of keyboard shortcuts (continued)

Key	Primary behavior
F7	Increase brightness
F8	Switch to external display
F10	Print Screen
F11	Home
F12	End
Copilot	Launch Copilot in Windows  NOTE: If Copilot in Windows is not available on your computer, the CoPilot key launches Windows Search. For more information about Copilot in Windows, search in the Knowledge Base Resource at Dell Support Site .

You can run the secondary tasks that are indicated by the symbols on the function keys by pressing the function key with **fn**, for example, **fn** and **F1**. See the table below for the list of secondary tasks and the key combinations to run them.



-  **NOTE:** Keyboard characters may differ depending on the keyboard language configuration. Keys that are used for tasks remain the same, regardless of the keyboard language.
-  **NOTE:** You can define the primary behavior of function keys in the **Function Key Behavior** menu of the BIOS setup program.

Table 18. Secondary tasks of keyboard keys

Key combination for task	What the task does
fn and F1	Operating system and application-specific F1 behavior
fn and F2	Operating system and application-specific F2 behavior
fn and F3	Operating system and application-specific F3 behavior
fn and F4	Operating system and application-specific F4 behavior
fn and F5	Operating system and application-specific F5 behavior
fn and F6	Operating system and application-specific F6 behavior
fn and F7	Operating system and application-specific F7 behavior
fn and F8	Operating system and application-specific F8 behavior
fn and F9	Operating system and application-specific F9 behavior
fn and F10	Operating system and application-specific F10 behavior
fn and F11	Operating system and application-specific F11 behavior
fn and F12	Operating system and application-specific F12 behavior

Keys with alternate characters

There are other keys on your keyboard with alternate characters. The symbols that are shown at the bottom of these keys are the main characters that are displayed when the key is pressed; the symbols that are shown at the top of these keys are displayed when the key is pressed with the shift key. For example, if you press **2**, **2** is displayed; if you press **Shift** and **2**, **@** is displayed.

Camera

The following table lists the camera specifications of your Precision 3590.

Table 19. Camera specifications

Description		Values
Number of cameras		One
Camera type		<ul style="list-style-type: none"> FHD RGB camera FHD RGB+IR camera FHD RGB+IR camera with Ambient Light Sensor, Express Sign-In with Presence Detection and Intelligent Privacy
Camera location		Front camera
Camera sensor type		CMOS sensor technology
Camera resolution:		
	Still image	2.07 megapixel
	Video	1920 x 1080 (FHD) at 30 fps
Infrared camera resolution:		
	Still image	0.23 megapixels
	Video	640 x 360 at 30 fps
Diagonal viewing angle:		
	Camera	80 degrees
	Infrared camera	86.60 degrees

Touchpad

The following table lists the touchpad specifications of your Precision 3590.

Table 20. Touchpad specifications

Description		Values
Touchpad resolution:		>300 DPI
Touchpad dimensions:		
	Horizontal	115 mm (4.52 in.)
	Vertical	67 mm (2.64 in.)
Touchpad gestures		For more information about the touchpad gestures that are available on: <ul style="list-style-type: none"> Windows, see the Microsoft Knowledge Base article at Microsoft Support Site. Ubuntu, see Ubuntu Support Site.

Power adapter

The following table lists the power adapter specifications of your Precision 3590.

Table 21. Power-adapter specifications

Description	Option one	Option two	Option three
Type	65 W adapter, USB-C	100 W adapter, USB-C	130 W adapter, USB-C
Power-adapter dimensions:			
Height	27.94 mm (1.10 in.)	26.41 mm (1.04 in.)	22.09 mm (0.87 in.)
Width	51.05 mm (2.01 in.)	59.94 mm (2.36 in.)	66.04 mm (2.60 in.)
Depth	112.01 mm (4.41 in.)	121.92 mm (4.80 in.)	143 mm (5.63 in.)
Input voltage	100 VAC-240 VAC	100 VAC-240 VAC	100 VAC-240 VAC
Input frequency	50 Hz-60 Hz	50 Hz-60 Hz	50 Hz-60 Hz
Input current (maximum)	1.70 A	1.70 A	1.80 A
Output current (continuous)	<ul style="list-style-type: none"> 20 V/3.25 A (continuous) 15 V/3 A (continuous) 9 V/3 A (continuous) 5 V/3 A (continuous) 	<ul style="list-style-type: none"> 20 V/5 A (continuous) 15 V/3 A (continuous) 9 V/3 A (continuous) 5 V/3 A (continuous) 	<ul style="list-style-type: none"> 20 V/6.50 A (continuous) 5 V/1 A (continuous)
Rated output voltage	<ul style="list-style-type: none"> 20 VDC 15 VDC 9 VDC 5 VDC 	<ul style="list-style-type: none"> 20 VDC 15 VDC 9 VDC 5 VDC 	<ul style="list-style-type: none"> 20 VDC 5 VDC
Temperature range:			
Operating	0°C to 40°C (32°F to 104°F)	0°C to 40°C (32°F to 104°F)	0°C to 40°C (32°F to 104°F)
Storage	-20°C to 70°C (-40°F to 158°F)	-40°C to 70°C (-40°F to 158°F)	-40°C to 70°C (-40°F to 158°F)
 CAUTION: Operating and storage temperature ranges may differ among components, so operating or storing the device outside these ranges may impact the performance of specific components.			

Power adapter requirements of Precision 3590 (option 1)

NOTE: If you did not purchase the Dell-branded power adapter that is recommended for your computer, ensure that the power adapter you use meets the following requirements.

The following table lists the power adapter requirements for your Precision 3590.

Table 22. Power adapter requirements

Description	Value
Power that is required from a power adapter to achieve optimal performance	65 W
Power that charges the computer at a slower speed	Less than 60 W

Table 22. Power adapter requirements (continued)

Description	Value
<p>i NOTE: A warning message may appear informing you about the use of a lower-powered adapter and slower charging speed.</p>	
<p>Minimum power that is required from a power adapter to operate the computer and charge the battery</p> <p>i NOTE: A warning message appears informing you about the use of a lower-powered adapter and slower charging speed.</p>	27 W
USB Power Delivery (PD) fast charging	Supported
ExpressCharge mode	<p>Supported</p> <p>i NOTE: Ensure that the computer with a 42 Wh battery is connected to a 65 W power adapter for this feature to be supported.</p> <p>i NOTE: ExpressCharge mode must also be enabled in the BIOS Setup screen. Select Power > Battery Configuration > ExpressCharge, then press Enter.</p>

Power adapter requirements of Precision 3590 (option 2)

i **NOTE:** If you did not purchase the Dell-branded power adapter that is recommended for your computer, ensure that the power adapter you use meets the following requirements.

The following table lists the power adapter requirements for your Precision 3590.

Table 23. Power adapter requirements

Description	Value
Power that is required from a power adapter to achieve optimal performance	100 W
<p>Power that charges the computer at a slower speed</p> <p>i NOTE: A warning message may appear informing you about the use of a lower-powered adapter and slower charging speed.</p>	Less than 75 W
<p>Minimum power that is required from a power adapter to operate the computer and charge the battery</p> <p>i NOTE: A warning message appears informing you about the use of a lower-powered adapter and slower charging speed.</p>	45 W
USB Power Delivery (PD) fast charging	Supported
ExpressCharge mode	<p>Supported</p> <p>i NOTE: Ensure that the computer with a 54 Wh battery is connected to a 100 W power adapter for this feature to be supported.</p> <p>i NOTE: ExpressCharge mode must also be enabled in the BIOS Setup screen. Select Power > Battery Configuration > ExpressCharge, then press Enter.</p>

Battery

The following table lists the battery specifications of your Precision 3590.

Table 24. Battery specifications

Description	Option one	Option two	Option three	Option four
Battery type	3 cell, 42 Wh, ExpressCharge, ExpressCharge Boost	3 cell, 42 Wh, Long Cycle Life, ExpressCharge	3 cell, 54 Wh, ExpressCharge, ExpressCharge Boost	3 cell, 54 Wh, Long Cycle Life, ExpressCharge
Battery voltage	11.40 VDC	11.40 VDC	11.40 VDC	11.40 VDC
Battery weight (minimum)	0.19 kg (0.41 lb)	0.19 kg (0.41 lb)	0.22 kg (0.48 lb)	0.22 kg (0.48 lb)
Battery dimensions:				
	Height	5.73 mm (0.22 in.)	5.73 mm (0.22 in.)	5.73 mm (0.22 in.)
	Width	263 mm (10.35 in.)	263 mm (10.35 in.)	263 mm (10.35 in.)
	Depth	68.90 mm (2.71 in.)	68.90 mm (2.71 in.)	68.90 mm (2.71 in.)
Temperature range:				
	Operating	<ul style="list-style-type: none"> Charge: 0°C to 45°C (32°F to 113°F) Discharge: 0°C to 70°C (32°F to 158°F) 	<ul style="list-style-type: none"> Charge: 0°C to 45°C (32°F to 113°F) Discharge: 0°C to 70°C (32°F to 158°F) 	<ul style="list-style-type: none"> Charge: 0°C to 45°C (32°F to 113°F) Discharge: 0°C to 70°C (32°F to 158°F)
	Storage	-20°C to 65°C (-4°F to 149°F)	-20°C to 65°C (-4°F to 149°F)	-20°C to 65°C (-4°F to 149°F)
Battery operating time	Varies depending on operating conditions and can significantly reduce under certain power-intensive conditions.			
Battery charging time (approximate)	<p>Express Charge Method:</p> <ul style="list-style-type: none"> 0°C to 15°C maximum allowable charge time from 0% to 100% RSOC is 4 hours. 16°C to 45°C normal express charge. 46°C to 50°C maximum allowable charge time from 0% to 100% RSOC is 3 hours. <p>Standard Charge/ Predominately AC</p>	<p>Express Charge Method:</p> <ul style="list-style-type: none"> 0°C to 15°C maximum allowable charge time from 0% to 100% RSOC is 4 hours. 16°C to 45°C normal express charge. 46°C to 50°C maximum allowable charge time from 0% to 100% RSOC is 3 hours. <p>Standard Charge/ Predominately AC User Charge Method:</p>	<p>Express Charge Method:</p> <ul style="list-style-type: none"> 0°C to 15°C maximum allowable charge time from 0% to 100% RSOC is 4 hours. 16°C to 45°C normal express charge. 46°C to 50°C maximum allowable charge time from 0% to 100% RSOC is 3 hours. <p>Standard Charge/ Predominately AC</p>	<p>Express Charge Method:</p> <ul style="list-style-type: none"> 0°C to 15°C maximum allowable charge time from 0% to 100% RSOC is 4 hours. 16°C to 45°C normal express charge. 46°C to 50°C maximum allowable charge time from 0% to 100% RSOC is 3 hours. <p>Standard Charge/ Predominately AC</p>

Table 24. Battery specifications (continued)

Description	Option one	Option two	Option three	Option four
	<p>User Charge Method:</p> <ul style="list-style-type: none"> 0°C to 15°C maximum allowable charge time from 0% to 100% RSOC is 4 hours. 16°C to 50°C maximum allowable charge time from 0% to 100% RSOC is 3 hours. <p>Express Charge Boost Charge Method (Fast Charge for Initial 35%):</p> <ul style="list-style-type: none"> 16°C to 45°C target charge time from 0% to 35% RSOC is 20 minutes for Accelerated Charge. 	<ul style="list-style-type: none"> 0°C to 15°C maximum allowable charge time from 0% to 100% RSOC is 4 hours. 16°C to 50°C maximum allowable charge time from 0% to 100% RSOC is 3 hours. 	<p>User Charge Method:</p> <ul style="list-style-type: none"> 0°C to 15°C maximum allowable charge time from 0% to 100% RSOC is 4 hours. 16°C to 50°C maximum allowable charge time from 0% to 100% RSOC is 3 hours. <p>Express Charge Boost Charge Method (Fast Charge for Initial 35%):</p> <ul style="list-style-type: none"> 16°C to 45°C target charge time from 0% to 35% RSOC is 20 minutes for Accelerated Charge. 	<p>User Charge Method:</p> <ul style="list-style-type: none"> 0°C to 15°C maximum allowable charge time from 0% to 100% RSOC is 4 hours. 16°C to 50°C maximum allowable charge time from 0% to 100% RSOC is 3 hours.
Coin-cell battery	CR2032	CR2032	CR2032	CR2032
<p>⚠ CAUTION: Operating and storage temperature ranges may differ among components, so operating or storing the device outside these ranges may impact the performance of specific components.</p> <p>⚠ CAUTION: Dell recommends that you charge the battery regularly for optimal power consumption. If your battery charge is completely depleted, connect the power adapter, turn on your computer, and then restart your computer to reduce the power consumption.</p>				

Display

The following table lists the display specifications of your Precision 3590.

Table 25. Display specifications

Description	Option one	Option two	Option three
Display type	15.6-inch Full High Definition (FHD)	15.6-inch Full High Definition (FHD)	15.6-inch Full High Definition (FHD), ComfortView Plus Low Blue Light, Battery Saving
Touch options	No	Yes	No
Display-panel technology	In-Plane Switching (IPS)	In-Plane Switching (IPS)	In-Plane Switching (IPS)
Display-panel dimensions (active area):			
Height	193.60 mm (7.62 in.)	193.60 mm (7.62 in.)	193.60 mm (7.62 in.)

Table 25. Display specifications (continued)

Description		Option one	Option two	Option three
	Width	344.20 mm (13.55 in.)	344.20 mm (13.55 in.)	344.20 mm (13.55 in.)
	Diagonal	396 mm (15.60 in.)	396 mm (15.60 in.)	396 mm (15.60 in.)
Display-panel native resolution		1920 x 1080	1920 x 1080	1920 x 1080
Luminance (typical)		250 nits	250 nits	400 nits
Megapixels		2.07	2.07	2.07
Color gamut		45% NTSC	45% NTSC	100% sRGB
Pixels Per Inch (PPI)		141	141	141
Contrast ratio (typical)		700:1	700:1	800:1
Response time (maximum)		35 millisecond	35 millisecond	35 millisecond
Refresh rate		60 Hz	60 Hz	60 Hz
Horizontal view angle		+/- 80 degrees	+/- 80 degrees	+/- 80 degrees
Vertical view angle		+/- 80 degrees	+/- 80 degrees	+/- 80 degrees
Pixel pitch		0.179 mm (0.007 in.) x 0.179 mm (0.007 in.)	0.179 mm (0.007 in.) x 0.179 mm (0.007 in.)	0.179 mm (0.007 in.) x 0.179 mm (0.007 in.)
Power consumption (maximum)		4.60 W	4.60 W	4.50 W
Anti-glare vs glossy finish		Anti-glare	Anti-glare	Anti-glare

Fingerprint reader (optional)

The following table lists the specifications of the optional fingerprint-reader of your Precision 3590.

Table 26. Fingerprint reader specifications

Description	Values
Sensor technology	Capacitive
Sensor resolution	500 dpi
Sensor pixel size	108 x 88

Sensor

The following table lists the sensor of your Precision 3590.

Table 27. Sensor

Sensor support
Ambient light sensor (optional)

Table 27. Sensor (continued)

Sensor support
Accelerometer in the base: ST Micro LIS2DW12TR
Accelerometer in the hinge-up (Upsell config with Emza/ALS/IR camera): ST Micro LNG2DMTR

GPU—Integrated

The following table lists the specifications of the integrated Graphics Processing Unit (GPU) supported by your Precision 3590.

Table 28. GPU—Integrated

Controller	Memory size	Processor
Intel Arc Graphics	Shared system memory	For Intel Core H processors and requires 128-bit (dual-channel) memory with minimum of 16 GB memory
Intel Graphics	Shared system memory	Intel Core Ultra 5/7

GPU—Discrete

The following table lists the specifications of the discrete Graphics Processing Unit (GPU) supported by your Precision 3590.

Table 29. GPU—Discrete

Controller	Memory size	Memory type
NVIDIA RTX 500 Ada Generation	4 GB	GDDR6

External display support

The following table lists the external display support for your Precision 3590.

Table 30. External display support

Graphics card	Supported external displays with laptop display enabled	Supported external displays with laptop display disabled
Intel Arc Graphics	3	4
Intel Graphics	3	4
 NOTE: For more information about external display support, see the External Display Connection Guide on Dell Support Site .		

Hardware security

The following table lists the hardware security of your Precision 3590.

Table 31. Hardware security

Hardware security
Trusted Platform Module (TPM) 2.0 discrete
FIPS 140-2 certification for TPM

Table 31. Hardware security (continued)

Hardware security
TCG Certification for TPM (Trusted Computing Group)
Finger Print Reader in Power Button available with and without ControlVault 3 Plus
ControlVault 3 Plus Advanced Authentication with FIPS 140-3 Level 3 Certification
Contacted Smart Card and ControlVault 3 Plus
Contactless Smart Card, NFC, and ControlVault 3 Plus
SED SSD NVMe, SSD, and hard drive (Opal and non-Opal) per SDL
FIPS 201 Full Scan FPR and ControlVault 3 Plus

Smart-card reader

Contactless smart-card reader

This section lists the contactless smart-card reader specifications of your Precision 3590. This module is only available in computers shipped with Smart-card readers.

Table 32. Contactless smart-card reader specifications

Title	Description	Dell ControlVault 3 Plus Contactless smart-card reader with NFC
Felica Card Support	Reader and software capable of supporting Felica contactless cards	Yes
Prox (Proximity) (125kHz) Card support	Reader and software capable of supporting Prox /Proximity/125 kHz contactless cards	No
ISO 14443 Type A Card Support	Reader and software capable of supporting ISO 14443 Type A contactless cards	Yes
ISO 14443 Type B Card Support	Reader and software capable of supporting ISO 14443 Type B contactless cards	Yes
ISO/IEC 21481	Reader and software capable of supporting ISO/IEC 21481 compliant contactless cards and tokens	Yes
ISO/IEC 18092	Reader and software capable of supporting ISO/IEC 21481 compliant contactless cards and tokens	Yes
ISO 15693 Card Support	Reader and software capable of supporting ISO15693 contactless cards	Yes
NFC Tag Support	Supports reading and processing of NFC compliant tag information	Yes
NFC Reader Mode	Support for NFC Forum Defined Reader mode	Yes
NFC Writer Mode	Support for NFC Forum Defined Writer mode	Yes
NFC Peer-to-Peer Mode	Support for NFC Forum Defined Peer to Peer mode	Yes

Table 32. Contactless smart-card reader specifications (continued)

Title	Description	Dell ControlVault 3 Plus Contactless smart-card reader with NFC
NFC Proximity OS Interface	Enumerates NFP (Near Field Proximity) device for operating system to utilize	Yes
PC/SC operating system interface	Personal Computer/Smart Card specification for integration of hardware readers into personal computer environments	Yes
CCID driver compliance	Common driver support for Integrated Circuit Card Interface Device for operating system level drivers	Yes
Dell ControlVault support	The device connects to Dell ControlVault for usage and processing	Yes

i NOTE: 125 Khz proximity cards are not supported.

Table 33. Supported cards

Manufacturer	Card
HID	jCOP readertest3 A card (14443a)
	1430 1L
	DESFire D8H
	DESFIRE 4K Standard - 1450NGGNN
	iClass 16K/16 - 2002PGGMN
	iClass SR 16K/16 - 2002HPGGMN
	iCLASS 2K tag
	iCLASS GP - 2003 PGGMN
	iClass Clamshell - 2080PMSMV
	iClass Prox 16K/16 - 2022BGGMNN
	Mifare M1P 1430 NGGNN
	iclass Prox 2020BGGMNM
	DesFire D8P 1456CSGMN
	iCLASS MIFARE Px GM49Y 2623BNPGGBNAB
	iCLASS MIFARE Px 8M1L
	iClass SEOS JW 5006PGGMN
	Crescendo iCLASS Px G8H
	iCLASS Seos IY
	SEOS JMC4 J1Y 5806VNG1NNN4
	SEOS Key FOB 5266PNNA
SEOS Clamshell 5656PMSAV	
SEOS + Prox 5106RGGMNN	
SEOS + DESFire 5906PNG1ANN7	
SEOS iClass 5006PGGMN7	
Seos Essential + Prox 551PPGGANN	

Table 33. Supported cards (continued)

Manufacturer	Card
	iCLASS 2K 2000PGGMN
	iCLASS 2K 3000PGGMN
	MIFARE DESFire 3700CPGGAN
	iCLASS DP
	DESFire 1Y
NXP/Mifare	Mifare DESFire 8K White PVC card
	Mifare Classic 1K White PVC card
	NXP Mifare Classic S50 ISO card
	Mifare DESFire 2K
	Mifare Plus S 2K/4K
	Mifare Plus X 4K
G&D	idOnDemand - SCE3.2 144K
	SCE6.0 FIPS 80K Dual + 1K Mifare
	SCE6.0 nonFIPS 80K Dual + 1K Mifare
	SCE6.0 FIPS 144K Dual + 1K Mifare
	SCE6.0 nonFIPS 144K Dual + 1K Mifare
	SCE7.0 FIPS 144K
Oberthur	idOnDemand - OCS5.2 80K
	ID-One Cosmo 64 RSA D V5.4 T = 0 card
	ID-One Cosmo 128K V5.5 card
Gemalto	TOP DL GX4 144K card
Sony	Felica RC-S962
	Felica RC-S965
	Felica RC-S966
PIVKey	C910 PKI
NIST	PIV1
IDENTIV	PIV programmed cards
	uTrust
Transport cards	Oyster (London) MIFARE DESFire
	T-Money (Korea)
	Octopus Card (Hong Kong)
	SUICA (Japan)

Table 34. Qualified NFC tags

NFC tag	Supported
Tap and do - NFC Forum Type 1 Tag - Topaz 512 (BCM920203)	Yes
Tap and do - NFC Forum Type 1 Tag - Topaz 512 (BCM20203T512)	Yes

Table 34. Qualified NFC tags (continued)

NFC tag	Supported
Tap and do - NFC Forum Type 1 Tag - Topaz (BCM20203T96)	Yes
Tap and do - NFC Forum Type 2 Tag - Mifare UltraLight	Yes
Tap and do - NFC Forum Type 2 Tag - Mifare UltraLight C	Yes
Tap and do - NFC Forum Type 2 Tag - NTAG203	Yes
Tap and do - NFC Forum Type 3 Tag - FeliCa Lite RC-S965	Yes
Tap and do - NFC Forum Type 3 Tag - FeliCa RC-S962	Yes
Tap and do - NFC Forum Type 4 Tag - Mifare DESFire EV1Card 2K	Yes
Tap and do - NFC Forum Type 4 Tag - Mifare DESFire EV1Card 4K	Yes
Tap and do - NFC Forum Type 4 Tag - Mifare DESFire EV1Card 8K	Yes
Tap and do - ISO 15693 - Tag-it Plus	Yes
HID I-code ISO card	Yes

Contacted smart-card reader

The following table lists the contacted smart-card reader specifications of your Precision 3590.

Table 35. Contacted smart-card reader specifications

Title	Description	Dell ControlVault 3 Plus Contacted smart-card reader
ISO 7816-3 Class A Card Support	Reader capable of reading 5 V powered smart card	Yes
ISO 7816-3 Class B Card Support	Reader capable of reading 3 V powered smart card	Yes
ISO 7816-3 Class C Card support	Reader capable of reading 1.8 V powered smart card	Yes
T = 0 support	Cards support character level transmission	Yes
T = 1 support	Cards support block level transmission	Yes
EMVCo Certified	Formally certified based on EMVCo smart card standards	Yes
PC/SC operating system interface	Personal Computer/Smart Card specification for integration of hardware readers into personal computer environments	Yes
CCID driver compliance	Common driver support for Integrated Circuit Card Interface Device for operating system level drivers	Yes
Windows Certified	Certified by the Windows Hardware Certification program	Yes
FIPS 201 (PIV/HSPD-12) Compliant	Device compliant with FIPS 201/PIV/HSPD-12 requirements	Yes

Table 35. Contacted smart-card reader specifications (continued)

Title	Description	Dell ControlVault 3 Plus Contacted smart-card reader
ISO 7816-1 Compliant	Specification for the physical characteristics of integrated circuit cards with contacts	Yes
ISO 7816-2 Compliant	Specification for the dimensions and location of the contacts	Yes
ISO 7816-3 Compliant	Specification for electrical interface and transmission protocols	Yes
ISO 7816-4 Compliant	Specification for organization, security and commands for interchange	Yes
Dell ControlVault support	Device connects to Dell ControlVault for usage and processing	Yes

Operating and storage environment

This table lists the operating and storage specifications of your Precision 3590.

Airborne contaminant level: G1 as defined by ISA-S71.04-1985

Table 36. Computer environment

Description	Operating	Storage
Temperature range	0°C to 35°C (32°F to 95°F)	-40°C to 65°C (-40°F to 149°F)
Relative humidity (maximum)	10% to 90% (non-condensing)	0% to 95% (non-condensing)
Vibration (maximum)*	0.66 GRMS	1.30 GRMS
Shock (maximum)	110 G†	160 G†
Altitude range	-15.2 m to 3048 m (-49.87 ft to 10,000 ft)	-15.2 m to 10,668 m (-49.87 ft to 35,000 ft)
 CAUTION: Operating and storage temperature ranges may differ among components, so operating or storing the device outside these ranges may impact the performance of specific components.		

* Measured using a random vibration spectrum that simulates the user environment.

† Measured using a 2 ms half-sine pulse.

Dell support policy

For information about Dell support policy, search in the Knowledge Base Resource at [Dell Support Site](#).

ComfortView Plus

 **WARNING: Prolonged exposure to blue light from the display may lead to long-term effects such as eye strain, eye fatigue, or damage to the eyes.**

Blue light is a color in the light spectrum which has a short wavelength and high energy. Chronic exposure to blue light, particularly from digital sources may disrupt sleep patterns and cause long-term effects such as eye strain, eye fatigue, or damage to the eyes.

The display on this computer is designed to minimize blue light and complies with TÜV Rheinland's requirement for low blue light displays.

Low blue light mode is enabled at the factory, so no further configuration is necessary.

To reduce the risk of eye strain, it is also recommended that you:

- Position the display at a comfortable viewing distance between 20 and 28 inches (50 cm and 70 cm) from your eyes.
- Blink frequently to moisten your eyes, wet your eyes with water, or apply suitable eye drops.
- Take an extended break for 20 minutes every two hours.
- Look away from your display, and gaze at a distant object at 20 ft (609.60 cm) away for at least 20 seconds during each break.

Using the privacy shutter

1. Slide the privacy shutter to the left to access the camera lens.
2. Slide the privacy shutter to the right to cover the camera lens.



Figure 9. Camera shutter

Dell Optimizer

This section provides the Dell Optimizer specifications of your Precision 3590.

On Precision 3590 with Dell Optimizer, the following features are supported:

- **ExpressConnect**—Automatically joins the access point with the strongest signal, and directs bandwidth to conferencing applications when in use.









- **ExpressSign-in**—The Intel Context Sensing Technology's proximity sensor detects your presence to instantly wake up the computer and login using the IR camera and Windows Hello feature. Windows locks when you walk away.
- **ExpressResponse**—Prioritizes the most important applications. Applications open faster and perform better.
- **ExpressCharge**—Extends the battery runtime and improves battery performance by adapting to your patterns.
- **Intelligent Audio**—Collaborate like you're in the same room. Intelligent Audio enhances your audio quality and reduces background noises, so you can hear and be heard, creating a better conference experience for all.

For more information about configuring and using these features, see [Dell Optimizer User Guide](#).

Working inside your computer



Safety instructions

Use the following safety guidelines to protect your computer from potential damage and to ensure your personal safety. Unless otherwise noted, each procedure in this document assumes that you have read the safety information that shipped with your computer.

-  **WARNING:** Before working inside your computer, read the safety information that is shipped with your computer. For more safety best practices, see [Dell Regulatory Compliance Home Page](#).
-  **WARNING:** Disconnect your computer from all power sources before opening the computer cover or panels. After you finish working inside the computer, replace all covers, panels, and screws before connecting your computer to an electrical outlet.
-  **CAUTION:** To avoid damaging the computer, ensure that the work surface is flat, dry, and clean.
-  **CAUTION:** You should only perform troubleshooting and repairs as authorized or directed by the Dell technical support team. Damage due to servicing that is not authorized by Dell is not covered by your warranty. See the safety instructions that is shipped with the product or at [Dell Regulatory Compliance Home Page](#).
-  **CAUTION:** Before touching anything inside your computer, ground yourself by touching an unpainted metal surface, such as the metal at the back of the computer. While you work, periodically touch an unpainted metal surface to dissipate static electricity which could harm internal components.
-  **CAUTION:** To avoid damaging the components and cards, handle them by their edges, and avoid touching the pins and the contacts.
-  **CAUTION:** When you disconnect a cable, pull it by its connector or its pull tab, not the cable itself. Some cables have connectors with locking tabs or thumbscrews that you must disengage before disconnecting the cable. When disconnecting cables, keep them evenly aligned to avoid bending the connector pins. When connecting cables, ensure that the connector on the cable is correctly oriented and aligned with the port.
-  **CAUTION:** Press and eject any installed card from the media-card reader.
-  **CAUTION:** Exercise caution when handling rechargeable Li-ion batteries in laptops. Swollen batteries should not be used and should be replaced and disposed properly.

Before working inside your computer

Steps

1. Save and close all open files and exit all open applications.
2. Shut down your computer. For Windows operating system, click **Start** >  **Power** > **Shut down**.
 -  **NOTE:** If you are using a different operating system, see the documentation of your operating system for instructions.
3. Turn off all the attached peripherals.
4. Disconnect your computer from the electrical outlets.
5. Disconnect all attached network devices and peripherals, such as keyboard, mouse, and monitor from your computer.
6. Remove any media card and optical drive from your computer, if applicable.
7. Enter the Service Mode.

Service Mode

Service Mode is used to cut off power without disconnecting the battery cable from the system board before conducting repairs in the computer.

 **CAUTION:** If you are unable to turn on the computer to put it into Service Mode, proceed to disconnect the battery cable. To disconnect the battery cable, follow the steps in [Removing the battery](#).

 **NOTE:** Ensure that your computer is shut down and the power adapter is disconnected.

- a. Press and hold the B key and the power button for 3 seconds or until the Dell logo appears on the screen.
- b. Press any key to continue.
- c. If the power adapter is not disconnected, a message prompting you to disconnect the power adapter appears on the screen. Disconnect the power adapter and then press any key to enter into the Service Mode. The Service Mode process automatically skips the following step if the **Owner Tag** of the computer is not set up in advance by the user.
- d. When the **ready-to-proceed** message appears on the screen, press any key to proceed. The computer emits three short beeps and shuts down immediately.
The computer shuts down and enters the Service Mode.

Safety precautions

This section details the primary steps to be followed before performing any disassembly instructions.

Observe the following safety precautions before you perform any installation or break-fix procedures involving disassembly or reassembly:

- Turn off the computer and all attached peripherals.
- Disconnect the computer from AC power.
- Disconnect all network cables and peripherals from the computer.
- Use an ESD field service kit when working inside any notebook to avoid electrostatic discharge (ESD) damage.
- Place the removed component on an anti-static mat after removing it from the computer.
- Wear shoes with nonconductive rubber soles to reduce the chance of getting electrocuted.
- Unplugging, pressing, and holding the power button for 15 seconds should discharge residual power in the system board.

Standby power

Dell products with standby power must be unplugged before you open the back cover. Systems that are equipped with standby power are powered while turned off. The internal power enables the computer to be remotely turned on (Wake-on-LAN) and suspended into a sleep mode and has other advanced power management features.

Bonding

Bonding is a method for connecting two or more grounding conductors to the same electrical potential. This is done by using a field service electrostatic discharge (ESD) kit. When connecting a bonding wire, ensure that it is connected to bare metal and never to a painted or nonmetal surface. Ensure that the wrist strap is secure and in full contact with your skin. Remove all jewelry, watches, bracelets, or rings before grounding yourself and the equipment.

Electrostatic discharge—ESD protection

ESD is a major concern when you handle electronic components, especially sensitive components such as expansion cards, processors, memory modules, and system boards. A slight charge can damage circuits in ways that may not be obvious, such as intermittent problems or a shortened product life span. As the industry pushes for lower power requirements and increased density, ESD protection is an increasing concern.

Due to the increased density of semiconductors used in recent Dell products, the sensitivity to static damage is now higher than in previous Dell products. For this reason, some previously approved methods of handling parts are no longer applicable.

Two recognized types of ESD damage are catastrophic and intermittent failures.

- **Catastrophic** – Catastrophic failures represent approximately 20 percent of ESD-related failures. The damage causes an immediate and complete loss of device functionality. An example of catastrophic failure is a memory module that has

received a static shock and immediately generates a "No POST/No Video" symptom with a beep code that is emitted for missing or nonfunctional memory.

- **Intermittent** – Intermittent failures represent approximately 80 percent of ESD-related failures. The high rate of intermittent failures means that most of the time when damage occurs, it is not immediately recognizable. The memory module receives a static shock, but the tracing is merely weakened and does not immediately produce outward symptoms that are related to the damage. The weakened trace may take weeks or months to melt, and in the meantime may cause degradation of memory integrity, intermittent memory errors, and so on.

Intermittent failures that are also called latent or "walking wounded" are difficult to detect and troubleshoot.

Perform the following steps to prevent ESD damage:

- Use a wired ESD wrist strap that is properly grounded. Wireless anti-static straps do not provide adequate protection. Touching the chassis before handling parts does not ensure adequate ESD protection on parts with increased sensitivity to ESD damage.
- Handle all static-sensitive components in a static-safe area. If possible, use anti-static floor pads and workbench pads.
- When unpacking a static-sensitive component from its shipping carton, do not remove the component from the anti-static packing material until you are ready to install the component. Before unwrapping the anti-static packaging, use the anti-static wrist strap to discharge the static electricity from your body. For more information about the wrist strap and ESD wrist strap tester, see [Components of an ESD Field Service Kit](#).
- Before transporting a static-sensitive component, place it in an anti-static container or packaging.

ESD Field Service kit

The unmonitored field service kit is the most commonly used service kit. Each Field Service kit includes three main components: anti-static mat, wrist strap, and bonding wire.

 **CAUTION: It is critical to keep ESD-sensitive devices away from internal parts that are insulated and often highly charged, such as plastic heat sink casings.**

Working Environment

Before deploying the ESD Field Service kit, assess the situation at the customer location. For example, deploying the kit for a server environment is different than for a desktop or laptop environment. Servers are typically installed in a rack within a data center; desktops or laptops are typically placed on office desks or cubicles. Always look for a large open flat work area that is free of clutter and large enough to deploy the ESD kit with additional space to accommodate the type of computer that is being repaired. The workspace should also be free of insulators that can cause an ESD event. On the work area, insulators such as styrofoam and other plastics should always be moved at least 12 inches or 30 centimeters away from sensitive parts before physically handling any hardware components.

ESD Packaging

All ESD-sensitive devices must be shipped and received in static-safe packaging. Metal, static-shielded bags are preferred. However, you should always return the damaged component using the same ESD bag and packaging that the new part arrived in. The ESD bag should be folded over and taped shut and all the same foam packing material should be used in the original box that the new part arrived in. ESD-sensitive devices should be removed from packaging only at an ESD-protected work surface, and parts should never be placed on top of the ESD bag because only the inside of the bag is shielded. Always place parts in your hand, on the anti-static mat, in the computer, or inside an ESD bag.

Components of an ESD Field Service kit

The components of an ESD Field Service kit are:

- **Anti-Static Mat** – The anti-static mat is dissipative and parts can be placed on it during service procedures. When using an anti-static mat, your wrist strap should be snug and the bonding wire should be connected to the anti-static mat and to any bare metal on the computer being worked on. Once deployed properly, service parts can be removed from the ESD bag and placed directly on the anti-static mat. ESD-sensitive items are safe in your hand, on the anti-static mat, in the computer, or inside an ESD bag.
- **Wrist Strap and Bonding Wire** – The wrist strap and bonding wire can be either directly connected between your wrist and bare metal on the hardware if the anti-static mat is not required, or connect to the anti-static mat to protect hardware that is temporarily placed on the mat. The physical connection of the wrist strap and bonding wire between your skin, the anti-static mat, and the hardware is known as bonding. Use only Field Service kits with a wrist strap, anti-static mat, and

bonding wire. Never use wireless wrist straps. Always be cautious that the internal wires of a wrist strap are prone to damage from normal wear and tear, and must be checked regularly with a wrist strap tester in order to avoid accidental ESD hardware damage. It is recommended to test the wrist strap and bonding wire at least once per week.

- **ESD Wrist Strap Tester** – The wires inside an ESD strap are prone to damage over time. When using an unmonitored kit, it is a best practice to regularly test the strap prior to each service, and at a minimum, test once per week. A wrist strap tester is the best method for doing this test. To perform the test, plug the bonding-wire of the wrist-strap into the tester while it is strapped to your wrist and push the button to test. A green LED is lit if the test is successful; a red LED is lit and an alarm sounds if the test fails.

 **NOTE:** It is recommended to always use the traditional wired ESD grounding wrist strap and protective anti-static mat when servicing Dell products. In addition, it is critical to keep sensitive parts separate from all insulator parts while servicing the computer.

Transporting sensitive components

When transporting ESD sensitive components such as replacement parts or parts to be returned to Dell, it is critical to place these parts in anti-static bags for safe transport.

After working inside your computer

About this task

 **CAUTION:** Leaving stray or loose screws inside your computer may severely damage your computer.

Steps

1. Replace all screws and ensure that no stray screws remain inside your computer.
2. Connect any external devices, peripherals, or cables you removed before working on your computer.
3. Replace any media cards, disks, or any other parts that you removed before working on your computer.
4. Connect your computer to their electrical outlets.
 -  **NOTE:** To exit service mode, ensure to connect the AC adapter to the power-adapter port on your computer.
5. Press the power button to turn on the computer. Your computer will automatically return to normal functioning mode.

BitLocker

 **CAUTION:** If BitLocker is not suspended before updating the BIOS, the Bitlocker key is not recognized the next time you reboot the computer. You will then be prompted to enter the recovery key to progress, and the system displays a prompt for the recovery key on each reboot. If the recovery key is not known, this can result in data loss or an operating system reinstall. For more information, see Knowledge Article: [updating the BIOS on Dell systems with BitLocker enabled](#).

The installation of the following components triggers BitLocker:

- Hard disk drive or solid-state drive
- System board

Recommended tools

The procedures in this document may require the following tools:

- Phillips screwdriver #1
- Plastic scribe







Screw list

- NOTE:** When removing screws from a component, it is recommended to note the screw type and the quantity of screws, and then place them in a screw storage box. This is to ensure that the correct number of screws and correct screw type is restored when the component is replaced.
- NOTE:** Some computers have magnetic surfaces. Ensure that the screws are not left attached to such surfaces when replacing a component.
- NOTE:** Screw color may vary depending on the configuration ordered.

Table 37. Screw list

Component	Screw type	Quantity	Screw image
Wireless card	M2x3	1	
5G WWAN bracket	M2x3	1	
5G WWAN thermal shield	M2x3	2	
M.2 2230 solid state drive in Slot 1 and Slot 2	M2x3	1	
Solid state drive thermal shield in Slot 2	M2x3	2	
Assembly-inner frame	M2x3	12	
Touchpad	M2x2.5	6	
System fan	M2x4	2	
Heat sink	M2x4	1	
Display cable	M2x3	2	
Type-C bracket	M2x4	3	
System board	M2x3	3	
Power button NOTE: Applicable to computer shipped both with and without fingerprint reader	M2x2.5	2	
Keyboard	M2x2	10	

Table 37. Screw list (continued)

Component	Screw type	Quantity	Screw image
Keyboard bracket	M2x2	21	
Display-cable bracket	M2x3	2	
Display panel	M2.5x3.5	4	
Display assembly hinges	M2.5x5	6	
Display hinges	M2.5x3.5	2	
Fingerprint-reader bracket	M2x3	1	
Smart-card reader	M2x2	2	

Major components of Precision 3590

The following image shows the major components of Precision 3590.

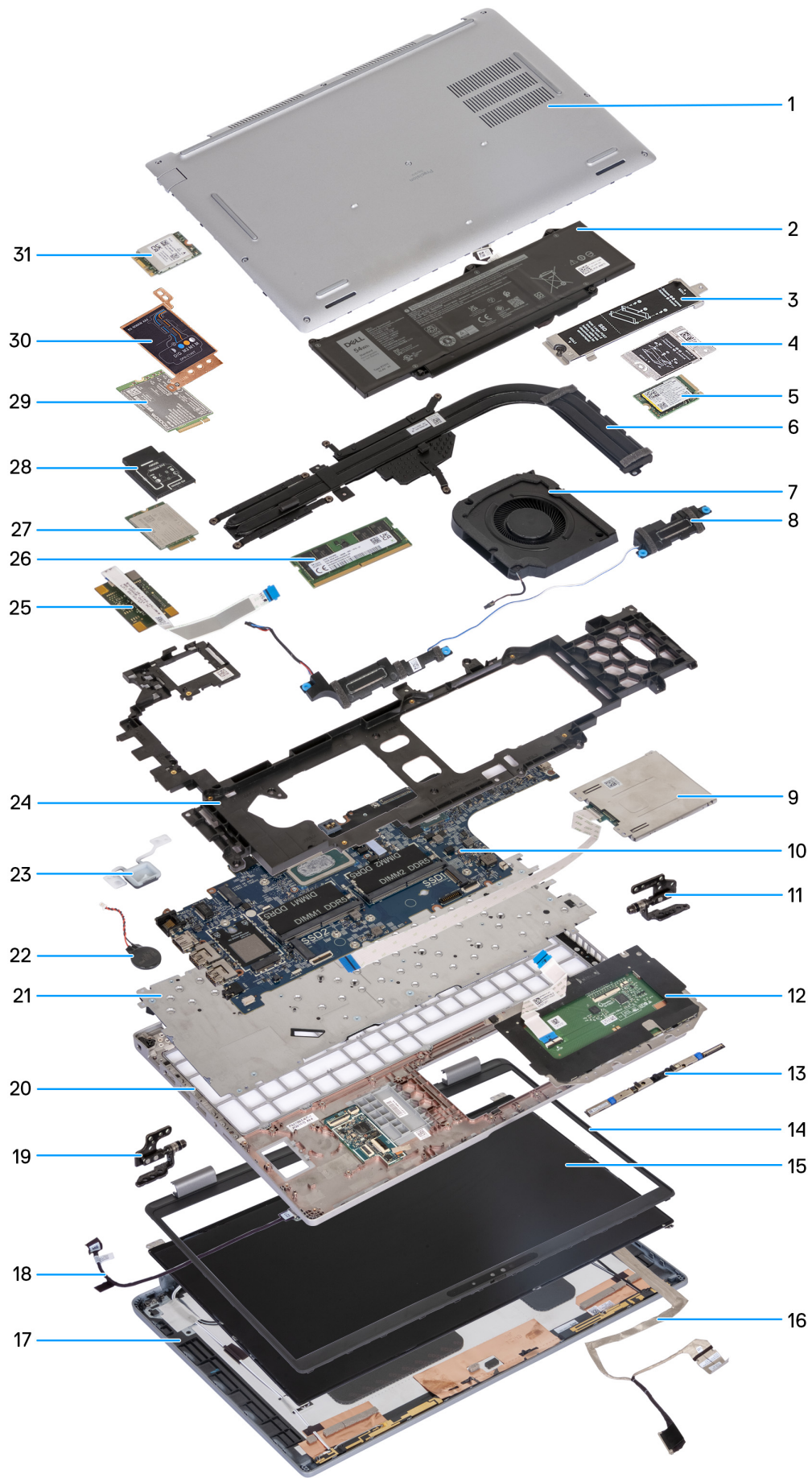



Figure 10. Major components of your computer

1. Base cover
2. Battery
3. M.2 2230/2280 SSD thermal shield for SSD Slot 1
4. M.2 2230 SSD thermal shield for SSD Slot 2
5. M.2 2230 SSD
6. Heat sink
7. Fan
8. Speakers
9. Smart-card reader (optional)
10. System board
11. Left hinges
12. Touchpad
13. Camera module
14. Display bezel
15. Display panel
16. Display cable
17. Display back cover
18. Sensor board with cable
19. Right hinges
20. Palm-rest assembly
21. Keyboard
22. Coin-cell battery
23. Power button
24. Assembly-inner frame
25. Fingerprint reader
26. Memory module
27. 4G WWAN card
28. 4G WWAN card bracket
29. 5G WWAN card
30. 5G WWAN-card shield
31. WLAN card

 **NOTE:** Dell provides a list of components and their part numbers for the original system configuration purchased. These parts are available according to warranty coverages purchased by the customer. Contact your Dell sales representative for purchase options.

Removing and installing Customer Replaceable Units (CRUs)

The replaceable components in this chapter are Customer Replaceable Units (CRUs).

 **CAUTION:** Customers can replace only the Customer Replaceable Units (CRUs) following the safety precautions and replacement procedures.

 **NOTE:** The images in this document may differ from your computer depending on the configuration you ordered.

SIM card tray

Removing the SIM card tray (optional)

Prerequisites

1. Follow the procedure in [Before working inside your computer](#).

 **NOTE:** The procedure for SIM card tray removal is only applicable for computers that are shipped with a WWAN module.

 **CAUTION:** Removing the SIM card when the computer is turned on can cause data loss or damage to the card. Ensure that your computer is turned off or the network connections are disabled.

About this task

The following images indicate the location of the SIM card tray and provide a visual representation of the removal procedure.

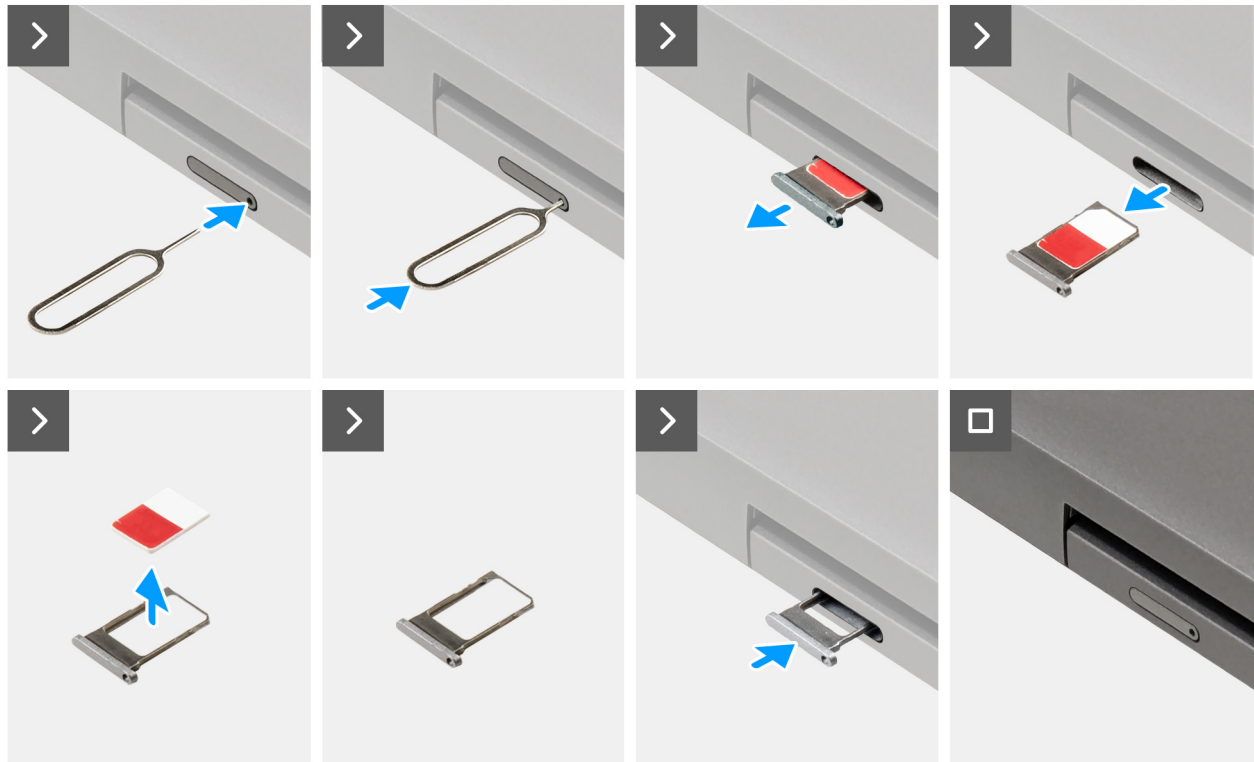

Figure 11. Removing the SIM card tray

Steps

1. Insert a pin into the release hole to release the SIM card tray.
2. Push the pin to disengage the lock, and eject the SIM card tray.
3. Slide the SIM card tray out of the slot on the computer.
4. Remove the SIM card from the SIM card tray.
5. Slide and push the SIM card tray back into the slot.

Installing the SIM card tray (optional)

Prerequisites

NOTE: The procedure for SIM card tray installation is only applicable for computers that are shipped with a WWAN module.

If you are replacing a component, remove the existing component before performing the installation procedure.

About this task

The following images indicate the location of the SIM card tray and provide a visual representation of the installation procedure.

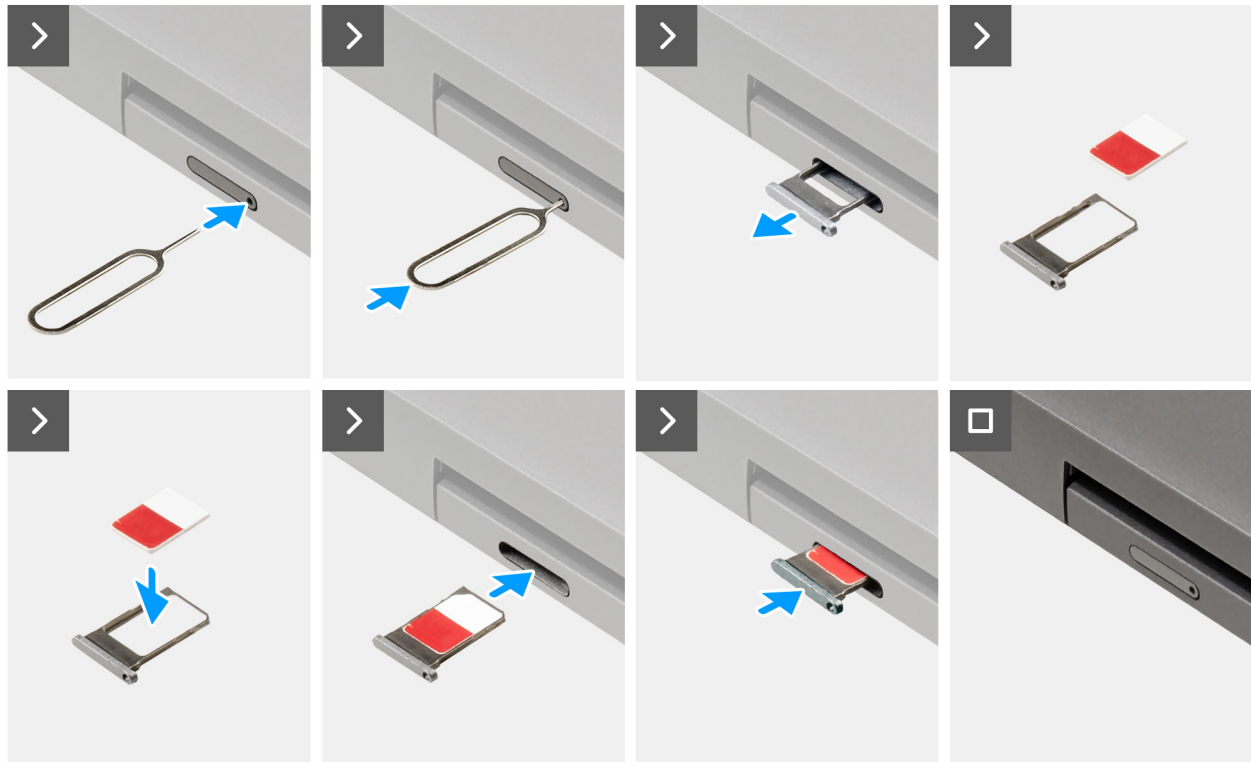

Figure 12. Installing the SIM card tray

Steps

1. Insert a pin into the release hole to release the SIM card tray.
2. Push the pin to disengage the lock, and eject the SIM card tray.
3. Slide the SIM card tray out of the slot on the computer.
4. Align and place the SIM card in the dedicated slot on the SIM card tray, with the metallic contact of the SIM card facing up.
5. Align the SIM card tray with the slot on the computer and carefully slide it in.
6. Slide the SIM card tray into the slot, until it clicks into place.

Next steps

1. Follow the procedure in [After working inside your computer](#).

Base cover

Removing the base cover

Prerequisites

1. Follow the procedure in [Before working inside your computer](#).

NOTE: Ensure that your computer is in Service Mode. For more information, see [Before working inside your computer](#).

CAUTION: If you are unable to turn on the computer, if your computer is unable to enter Service Mode, or the computer does not support Service Mode, proceed to disconnect the battery cable.

2. Remove the SIM card.

About this task

NOTE: Before removing the base cover, ensure that there is no microSD-card that is installed in the microSD-card slot on your computer.

The following images indicate the location of the base cover and provide a visual representation of the removal procedure.

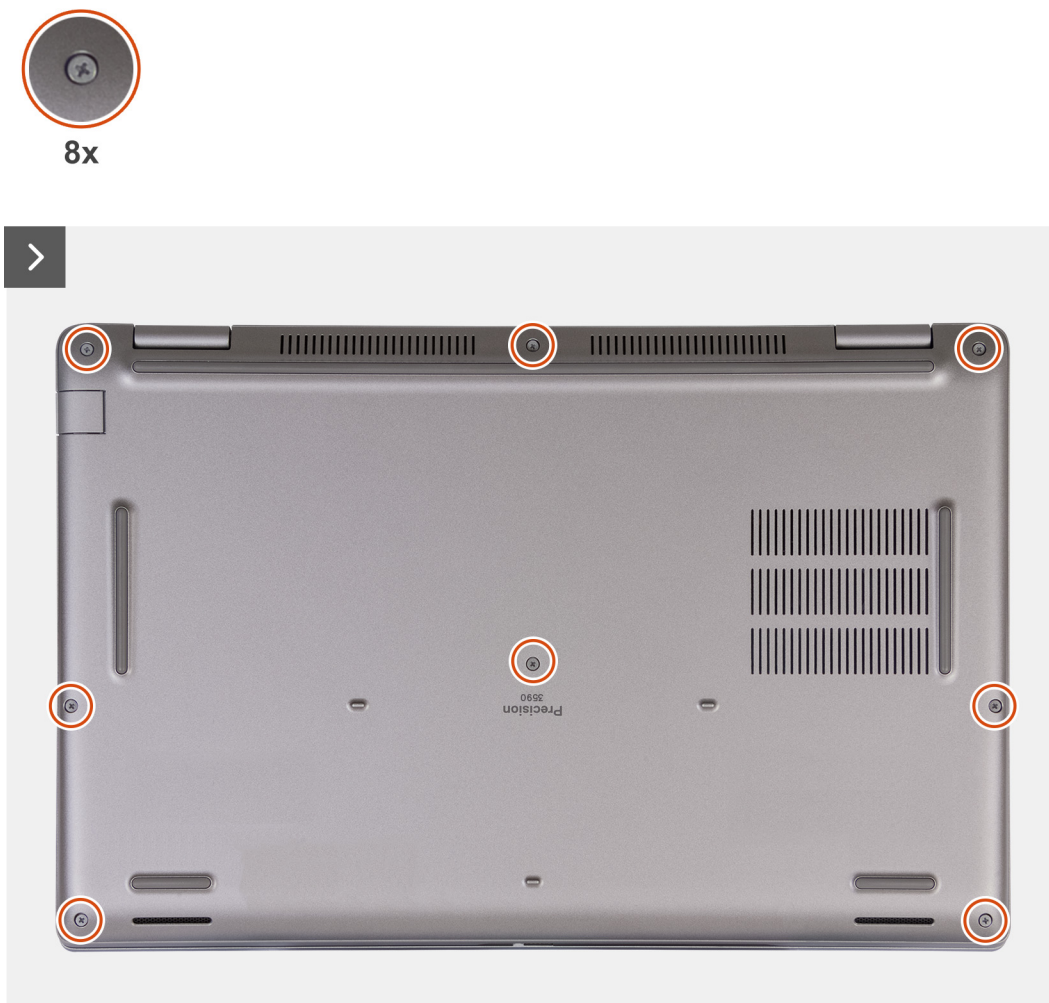

Figure 13. Loosen the captive screws

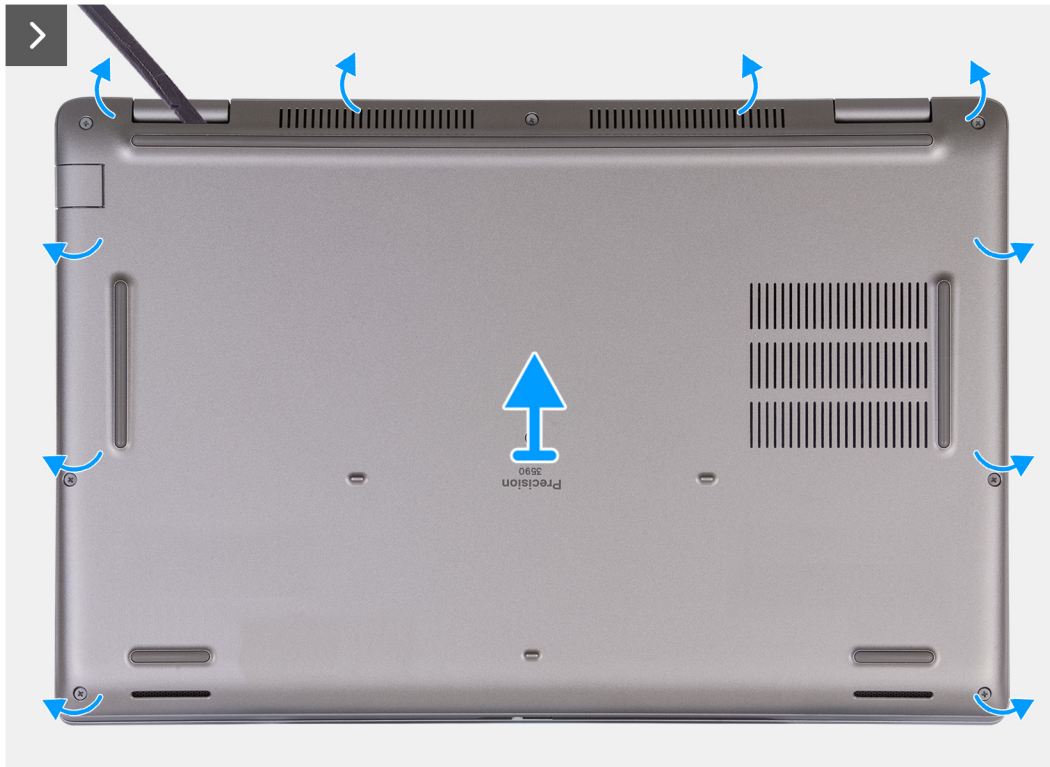

Figure 14. Removing the base cover

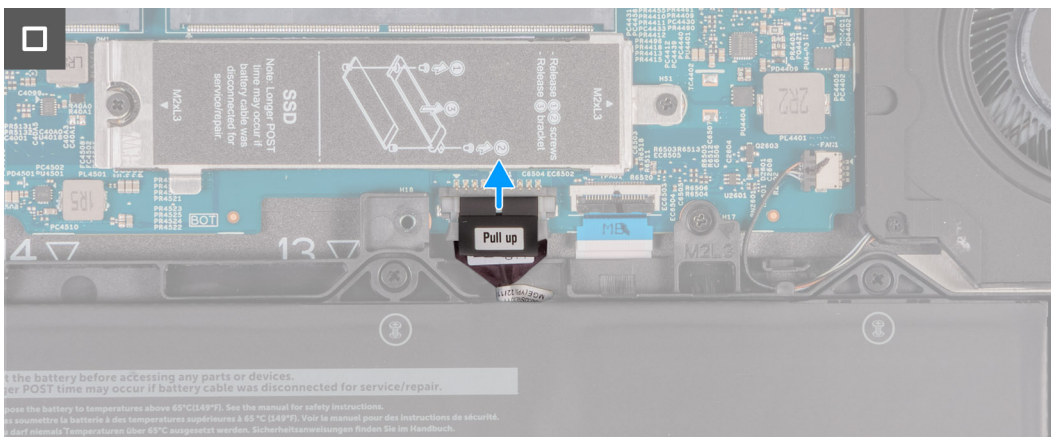

Figure 15. Disconnecting the battery cable

Steps

1. Loosen the eight captive screws that secure the base cover to the palm-rest assembly.
2. Using a plastic scribe, pry open the base cover from the recesses that are located in the U-shaped indents at the top edge of the base cover near the hinges.
3. Lift the base cover off the keyboard and palm-rest assembly.
 - NOTE:** Ensure that your computer is in Service Mode. If your computer is unable to enter Service Mode, disconnect the battery cable from the system board. To disconnect the battery cable, follow steps 4 and 5.
4. Disconnect the battery cable from the battery cable connector (BATT1) on the system board.
5. Press and hold the power button for five seconds to ground the computer and drain the flea power.

Installing the base cover

Prerequisites

If you are replacing a component, remove the existing component before performing the installation procedure.

About this task

The following images indicate the location of the base cover and provide a visual representation of the installation procedure.

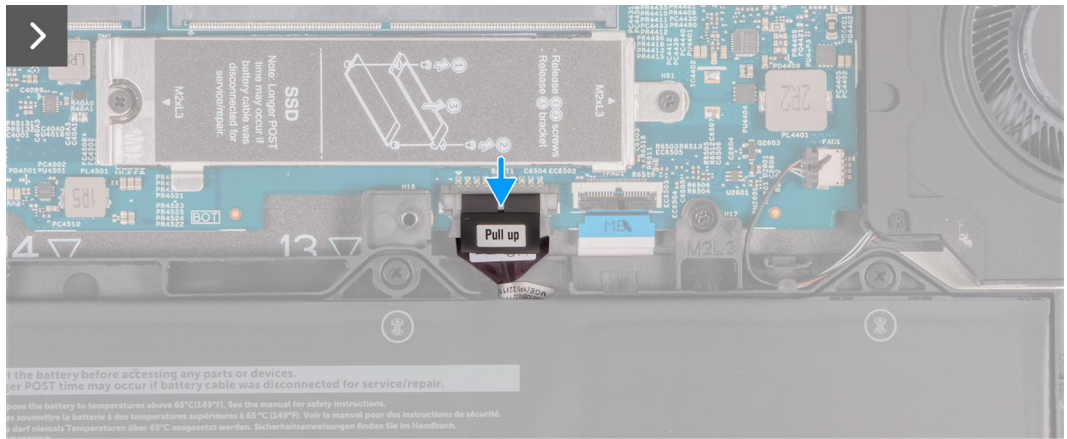

Figure 16. Connecting the battery cable



8x



Figure 17. Installing the base cover



Figure 18. Tighten the captive screws

NOTE: If the battery is not a pre-requisite and if you have disconnected the battery cable, ensure to connect the battery cable. To connect the battery cable, follow step 1 and step 2 in the procedure.

Steps

1. Connect the battery cable to the battery cable connector (BATT1) on the system board.
2. Align the screw holes on the base cover with the screw holes on the palm-rest and keyboard assembly, and then snap the base cover into place.
3. Tighten the eight captive screws that secure the base cover to the palm-rest and keyboard assembly.

Next steps

1. Install the [SIM card](#).
2. Follow the procedure in [After working inside your computer](#).

NOTE: Ensure that your computer is in Service Mode. For more information, see [Before working inside your computer](#).

Wireless card

Removing the wireless card

Prerequisites

1. Follow the procedure in [Before working inside your computer](#).
2. Remove the [SIM card](#).
3. Remove the [base cover](#).

About this task

The following images indicate the location of the wireless card and provide a visual representation of the removal procedure.

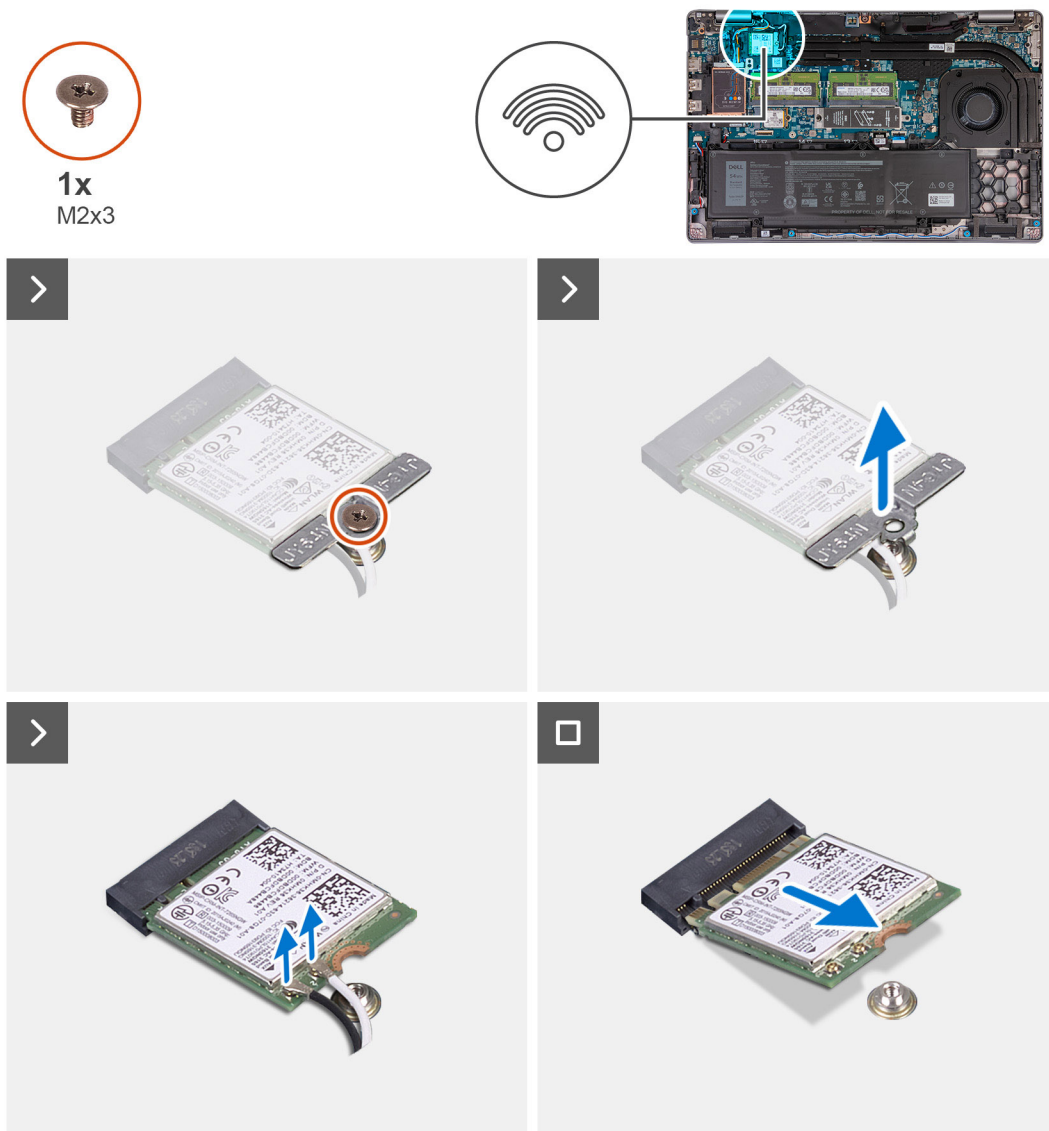

Figure 19. Removing the wireless card

Steps

1. Remove the screw (M2x3) that secures the wireless-card bracket to the wireless card and palm-rest and keyboard assembly.
2. Lift the wireless-card bracket off the wireless card.
3. Disconnect the antenna cables from the wireless card.
4. Slide and remove the wireless card off the wireless-card slot.

Installing the wireless card

Prerequisites

If you are replacing a component, remove the existing component before performing the installation process.

About this task

The following images indicate the location of the wireless card and provide a visual representation of the installation procedure.

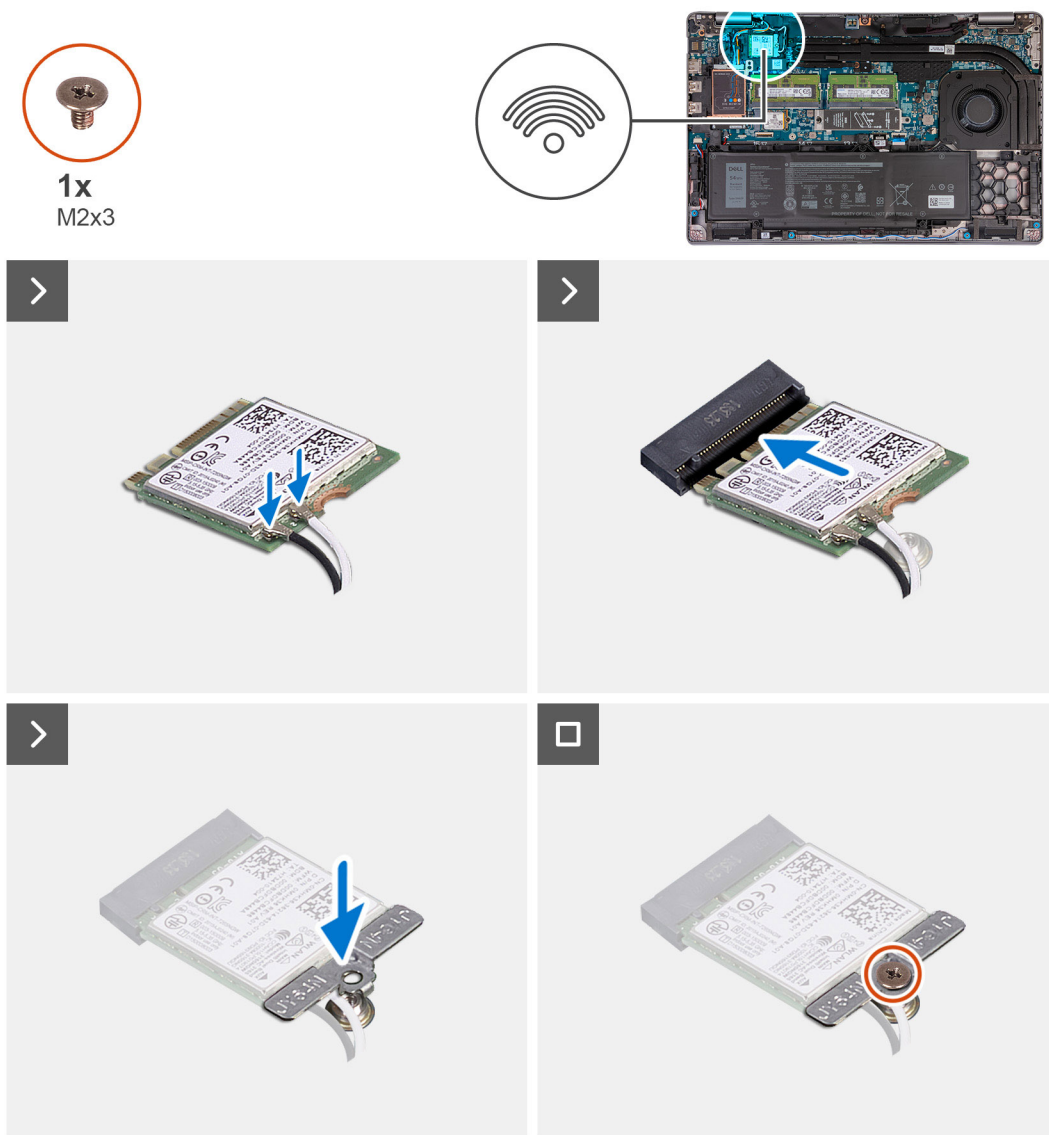

Figure 20. Installing the wireless card

Steps

1. Connect the antenna cables to the wireless card.

The following table provides the antenna-cable color scheme for the wireless card that is supported for your computer.

Table 38. Antenna-cable color scheme

Connectors on the wireless card	Antenna-cable color	Silkscreen marking	
Main	White	MAIN	△ (white triangle)
Auxiliary	Black	AUX	▲ (black triangle)

2. Align the notch on the wireless card with the tab on the wireless-card slot.
3. Adhere the wireless card at an angle into the wireless-card slot.
4. Align the screw hole on the wireless-card bracket with the screw hole on the wireless card and palm-rest and keyboard assembly.
5. Tighten the screw (M2x3) that secures the wireless-card bracket to the wireless card and the palm-rest and keyboard assembly.

Next steps

1. Install the [base cover](#).
2. Install the [SIM card](#).
3. Follow the procedure in [After working inside your computer](#).

Wireless Wide Area Network (WWAN) card

Removing the 4G WWAN card

Prerequisites

1. Follow the procedure in [Before working inside your computer](#).
2. Remove the [SIM card](#).
3. Remove the [base cover](#).

About this task

 **NOTE:** The 4G WWAN card is available only on certain configurations. It is connected to the computer with two antenna cables.

The following images indicate the location of the 4G WWAN card and provide a visual representation of the removal procedure.



1x
M2x3

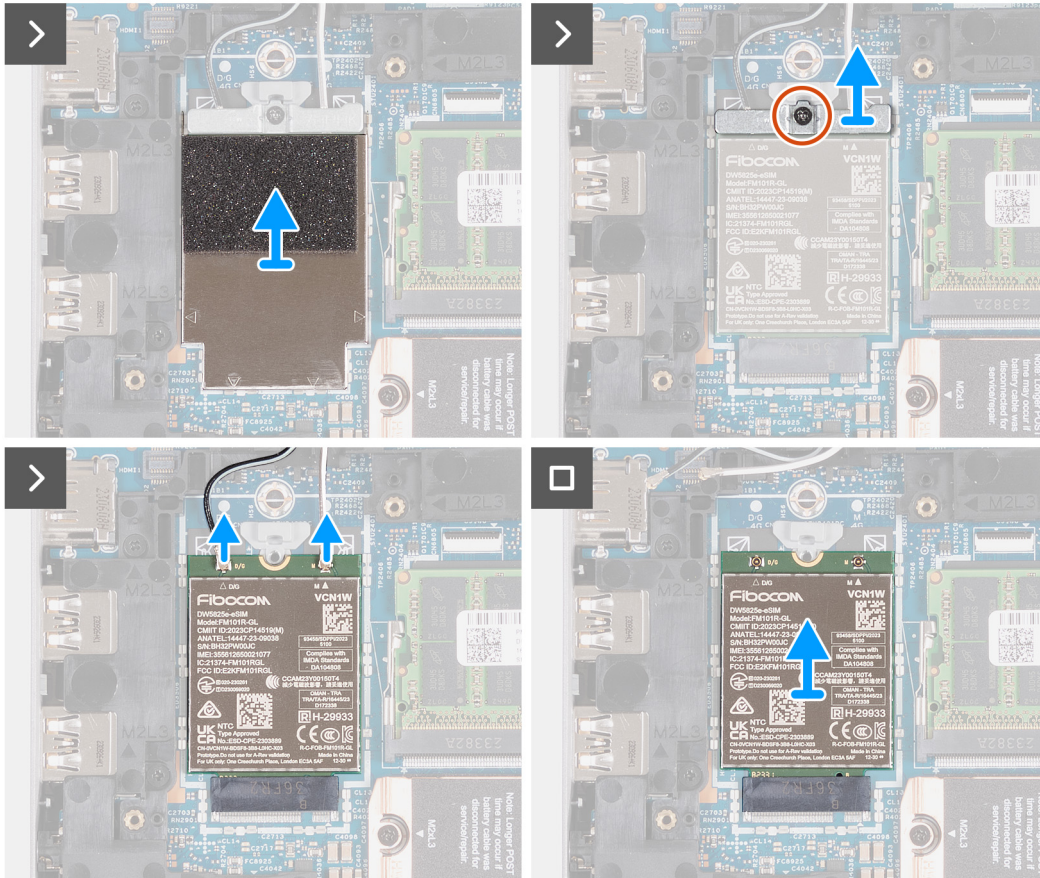
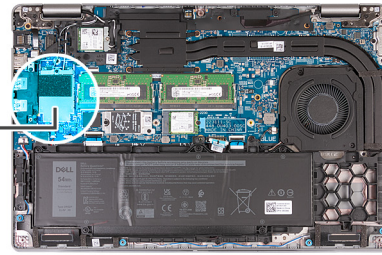

Figure 21. Removing the 4G WWAN card

Steps

1. Using a plastic scribe, pry open the 4G WWAN-card shield that secures the 4G WWAN card to the palm-rest assembly.
2. Lift the 4G WWAN-card shield off the 4G WWAN card.
3. Remove the screw (M2x3) that secures the 4G WWAN-card bracket to the 4G WWAN card and palm-rest assembly.
4. Lift the 4G WWAN-card bracket off the 4G WWAN card and palm-rest assembly.
5. Disconnect the antenna cables from the 4G WWAN card.
6. Remove the 4G WWAN card off the 4G WWAN-card slot on the system board.

- NOTE:** If you are replacing the 4G WWAN card, ensure that the thermal pad is in place.
- NOTE:** If you are replacing the system board, ensure to peel the thermal pad from the old system board to the new system board.
- NOTE:** If the thermal pad is damaged, peel the thermal pad from the system board and replace it with a new thermal pad. The thermal pad must be purchased separately.

Installing the 4G WWAN card

Prerequisites

If you are replacing a component, remove the existing component before performing the installation process.

About this task

NOTE: The 4G WWAN card is available only on certain configurations. It is connected to the computer with two antenna cables.

The following images indicate the location of the 4G WWAN card and provide a visual representation of the installation procedure.

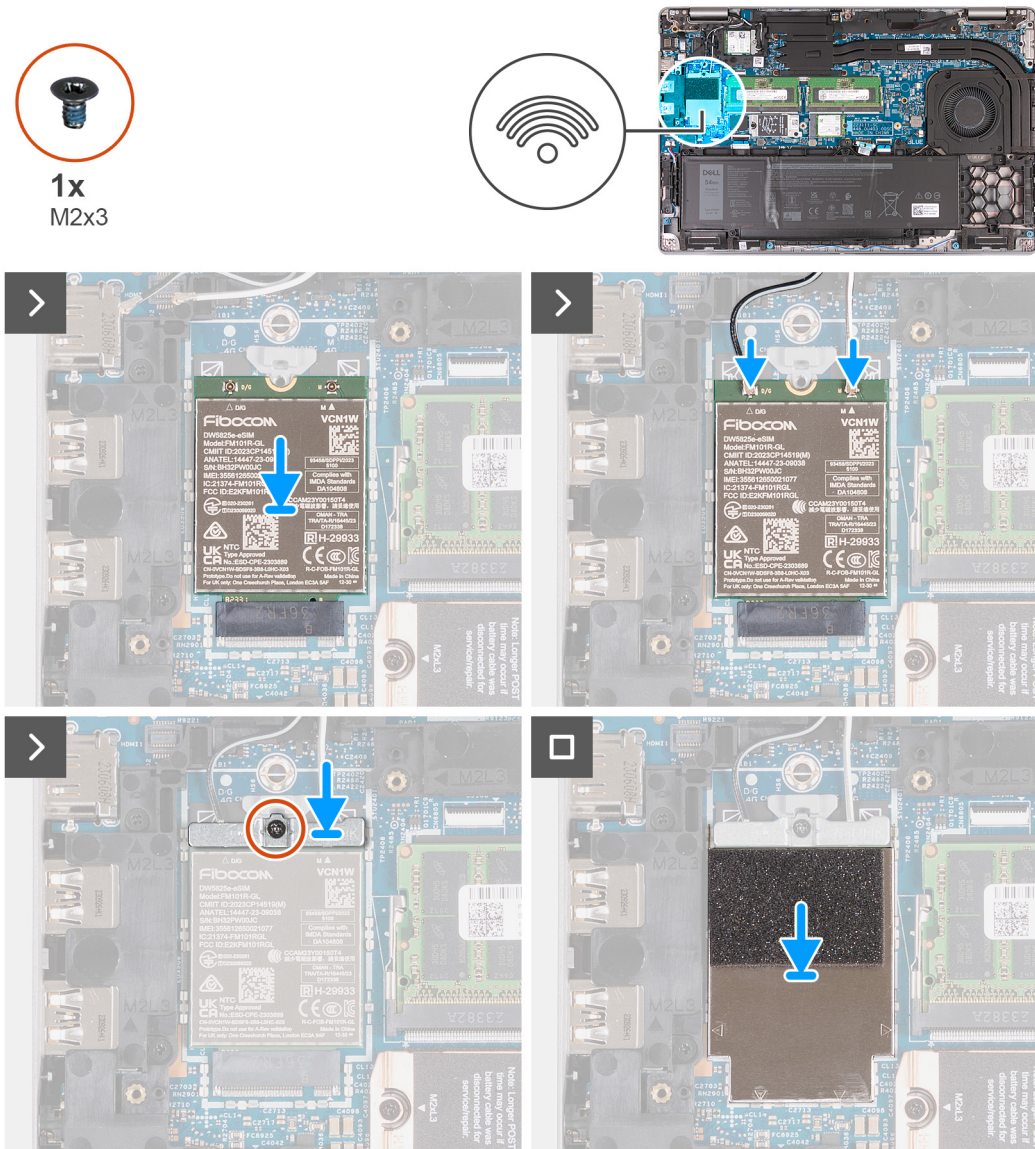

Figure 22. Installing the 4G WWAN card

Steps

- NOTE:** If you are replacing the 4G WWAN card, ensure that the thermal pad is in place.
- NOTE:** If you are replacing the system board, ensure to peel the thermal pad from the old system board to the new system board.

NOTE: If the thermal pad is damaged, peel the thermal pad from the system board and replace it with a new thermal pad. The thermal pad must be purchased separately.

Align the notch on the 4G WWAN card with the tab on the 4G WWAN-card slot.

2. Insert the 4G WWAN card at an angle into the 4G WWAN-card slot.
3. Connect the antenna cables to the 4G WWAN card.

The following table provides the antenna-cable color scheme for the 4G WWAN card that is supported on your computer.

Table 39. Antenna-cable color scheme for 4G WWAN cards

Connectors on the WWAN card	Antenna-cable color	Silkscreen marking	
Main	White	MAIN	△ (white triangle)
Auxiliary	Black	AUX	▲ (black triangle)

4. Align the screw hole on the 4G WWAN-card bracket with the screw hole on the 4G WWAN card and palm-rest assembly.
5. Replace the screw (M2x3) that secures the wireless-card bracket to the wireless card and the palm-rest assembly.
6. Align and place the 4G WWAN-card shield on the 4G WWAN card.

Next steps

1. Install the [base cover](#).
2. Install the [SIM card](#).
3. Follow the procedure in [After working inside your computer](#).

Removing the 5G WWAN card

Prerequisites

1. Follow the procedure in [Before working inside your computer](#).
2. Remove the [SIM card](#).
3. Remove the [base cover](#).

About this task

NOTE: The 5G WWAN card is available only on certain configurations. It is connected to the computer with four antenna cables.

The following images indicate the location of the 5G WWAN card and provide a visual representation of the removal procedure.



3x
M2x3

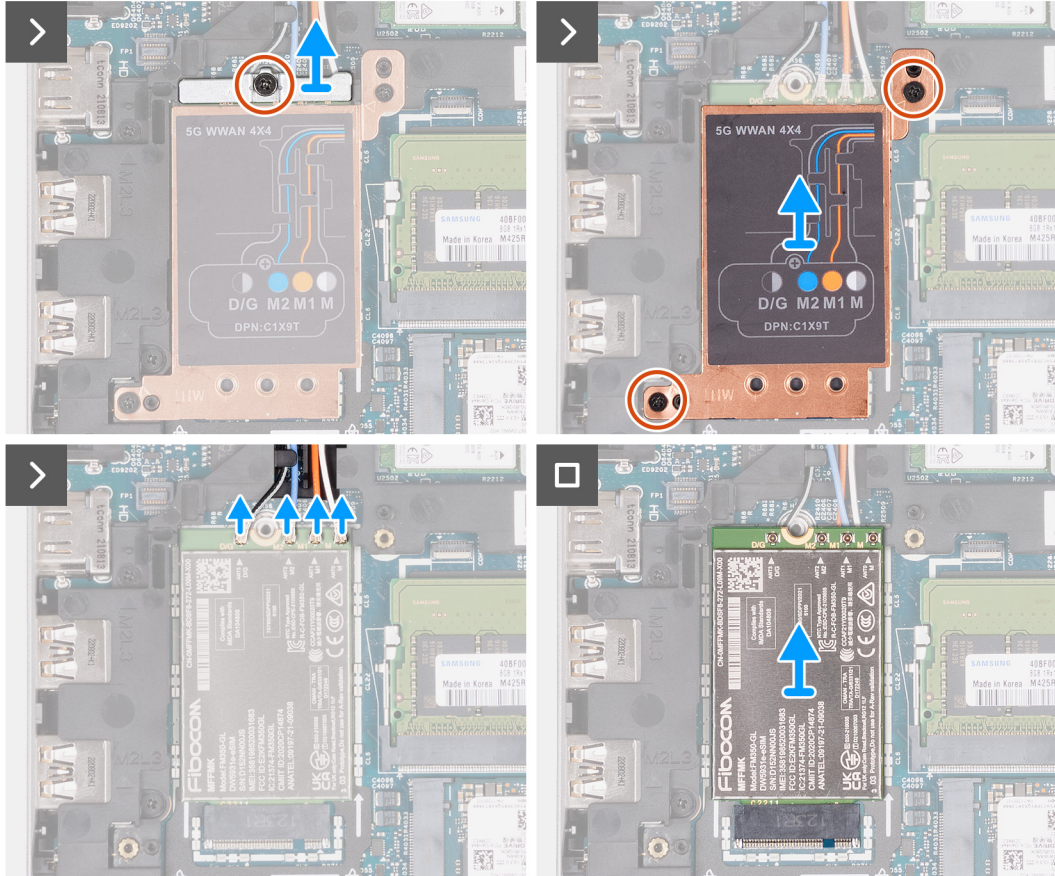
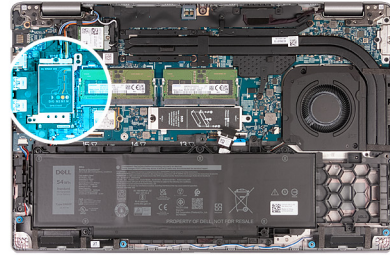

Figure 23. Removing the 5G WWAN card

Steps

1. Remove the screw (M2x3) that secures the 5G WWAN-card bracket to the 5G WWAN card.
2. Lift the 5G WWAN-card bracket off the 5G WWAN card.
3. Remove the two screws (M2x3) that secure the 5G WWAN-card shield to the palm-rest and keyboard assembly.
4. Lift the 5G WWAN-card shield off the 5G WWAN card.
5. Disconnect the antenna cables from the 5G WWAN card.
6. Slide and remove the 5G WWAN card off the 5G WWAN-card slot on the system board.

- NOTE:** If you are replacing the 5G WWAN card, ensure that the thermal pad is in place.
- NOTE:** If you are replacing the system board, ensure to peel the thermal pad from the old system board to the new system board.
- NOTE:** If the thermal pad is damaged, peel the thermal pad from the system board and replace it with a new thermal pad. The thermal pad must be purchased separately.

Installing the 5G WWAN card

Prerequisites

If you are replacing a component, remove the existing component before performing the installation process.

About this task

NOTE: The 5G WWAN card is available only on certain configurations. It is connected to the computer with four antenna cables.

The following images indicate the location of the 5G WWAN card and provide a visual representation of the installation procedure.

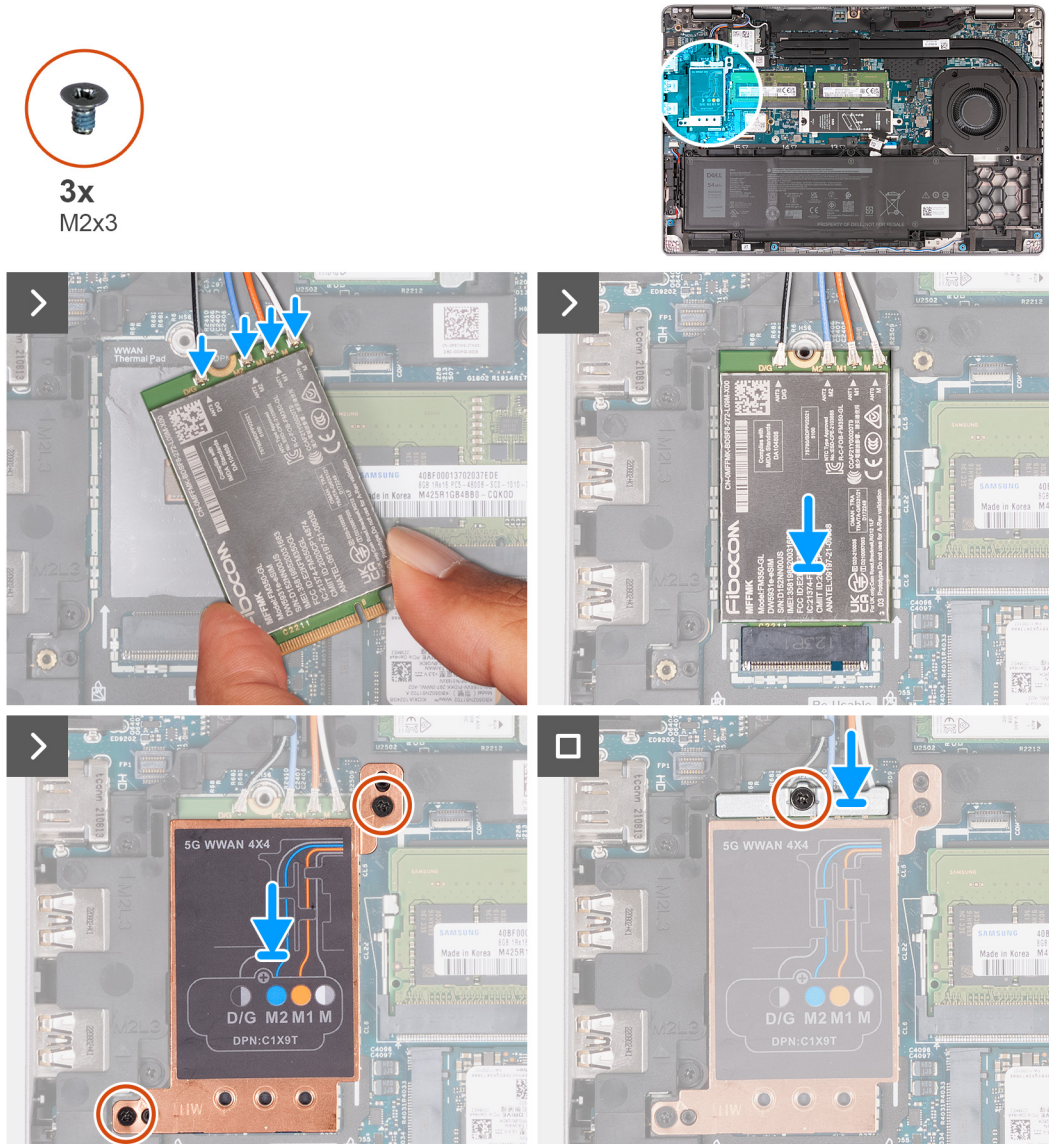

Figure 24. Installing the 5G WWAN card

Steps

- NOTE:** If you are replacing the 5G WWAN card, ensure that the thermal pad is in place.
- NOTE:** If you are replacing the system board, ensure to peel the thermal pad from the old system board to the new system board.

NOTE: If the thermal pad is damaged, peel the thermal pad from the system board and replace it with a new thermal pad. The thermal pad must be purchased separately.

Connect the antenna cables to the 5G WWAN card.

The following table provides the antenna-cable color scheme for the 5G WWAN card that is supported on your computer.

Table 40. Antenna-cable color scheme for 5G WWAN cards

Connectors on the WWAN card	Antenna-cable color	Silkscreen marking	
D/G	Black with a thin white stripe	ANT3 D/G	△ (white triangle)
M2	Blue	ANT2 M2	△ (white triangle)
M1	Orange	ANT1 M1	△ (white triangle)
M	White with a thin gray stripe	ANT0 M	△ (white triangle)

2. Align the notch on the 5G WWAN card with the tab on the 5G WWAN-card slot.
3. Insert the 5G WWAN card at an angle into the 5G WWAN-card slot.
4. Align the screw hole on the 5G WWAN-card bracket with the screw hole on the 5G WWAN card and palm-rest assembly.
5. Replace the screw (M2x3) that secures the wireless-card bracket to the wireless card and the palm-rest assembly.
6. Align and place the 5G WWAN-card shield on the 5G WWAN card.
7. Replace the screw (M2x3) that secures the 5G WWAN bracket to the 5G WWAN card.

Next steps

1. Install the [base cover](#).
2. Install the [SIM card](#).
3. Follow the procedure in [After working inside your computer](#).

Memory module

Removing the memory module

Prerequisites

1. Follow the procedure in [Before working inside your computer](#).
2. Remove the [SIM card](#).
3. Remove the [base cover](#).

About this task

The following images indicate the location of the memory module and provide a visual representation of the removal procedure.

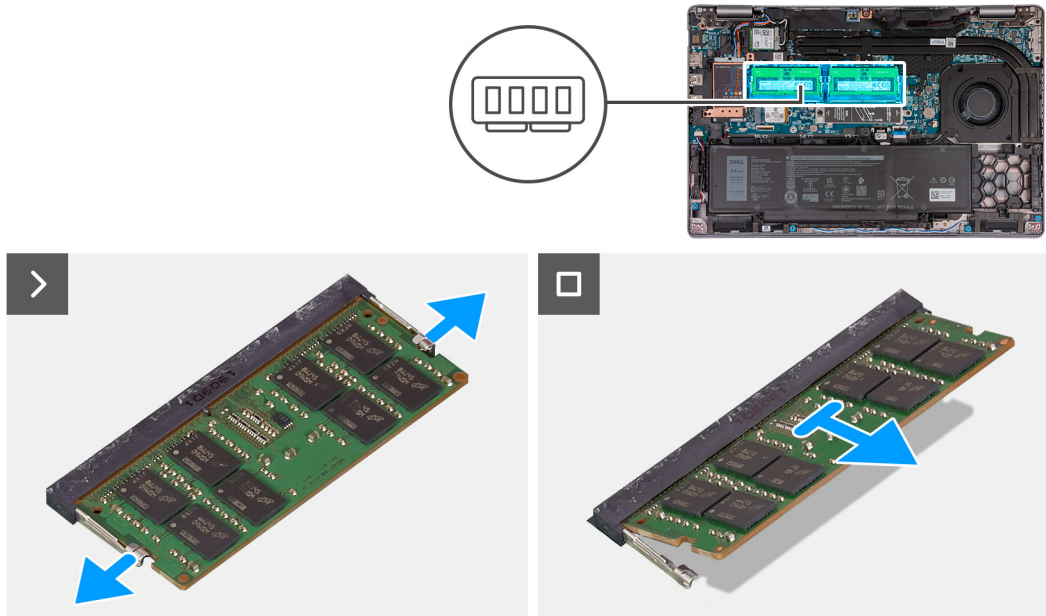

Figure 25. Removing the memory module

Steps

1. Using your fingertips, spread apart the securing clips on the memory-module slot until the memory module pops up.
2. Slide and remove the memory module from the memory-module slot on the system board.

i **NOTE:** Repeat step 1 and step 2 if there is more than one memory module installed on your computer.

⚠ **CAUTION:** To prevent damage to the memory module, hold the memory module by the edges. Do not touch the components or metallic contacts on the memory module as electrostatic discharge (ESD) can inflict severe damage on the components. To read more about ESD protection, see [ESD protection](#).

Installing the memory module

Prerequisites

If you are replacing a component, remove the existing component before performing the installation process.

About this task

The following images indicate the location of the memory module and provide a visual representation of the installation procedure.

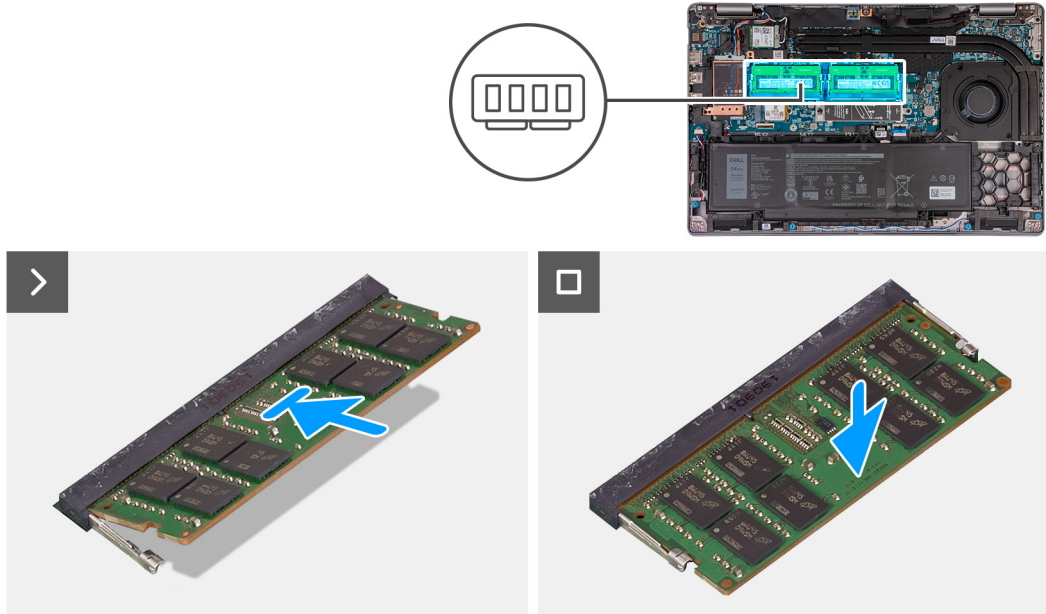

Figure 26. Installing the memory module

Steps

1. Align the notch on the memory module with the tab on the memory-module slot.
2. Slide the memory module firmly into the slot at an angle and press the memory module down until it clicks into place.

i **NOTE:** If you do not hear or feel the click, remove the memory module and reinstall it.

⚠ CAUTION: To prevent damage to the memory module, hold the memory module by the edges. Do not touch the components or metallic contacts on the memory module as electrostatic discharge (ESD) can inflict severe damage on the components. To read more about ESD protection, see [ESD protection](#).

Next steps

1. Install the [base cover](#).
2. Install the [SIM card](#).
3. Follow the procedure in [After working inside your computer](#).

Solid State Drive (SSD)

Removing the M.2 2230 SSD from slot 1 (SSD1)

Prerequisites

1. Follow the procedure in [Before working inside your computer](#).
2. Remove the [SIM card](#).
3. Remove the [base cover](#).

About this task

The following images indicate the location of the M.2 2230 SSD in slot 1 (SSD1) and provide a visual representation of the removal procedure.

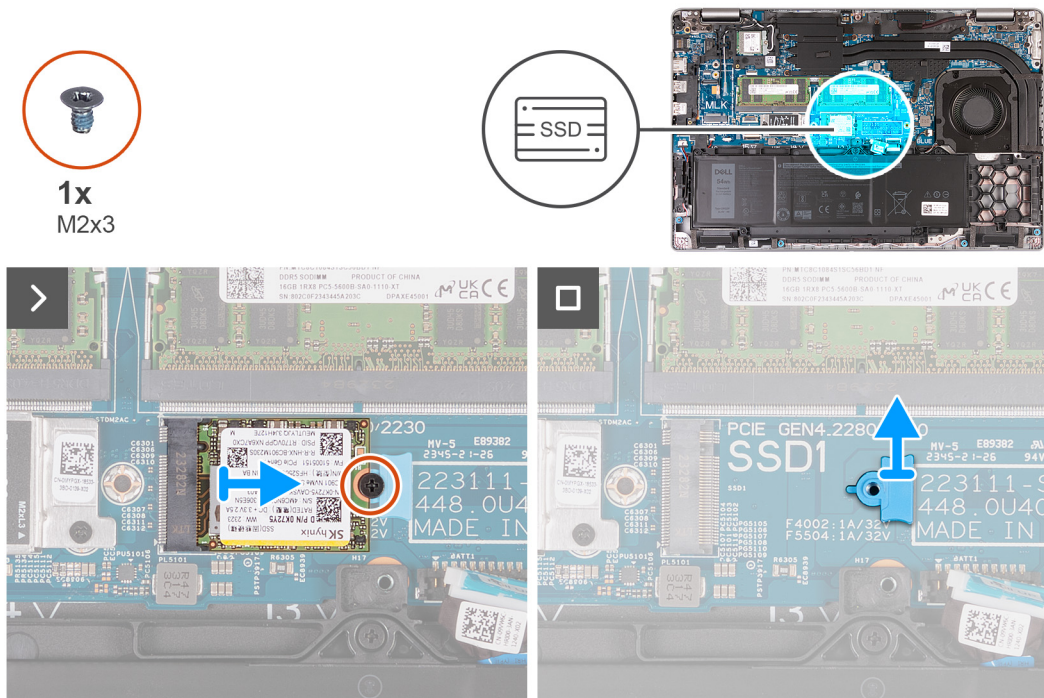

Figure 27. Removing the M.2 2230 SSD from slot 1

Steps

1. Remove the screw (M2x3) that secures the M.2 2230 SSD to the SSD bracket and palm-rest assembly.
2. Slide and lift the M.2 2230 SSD off the SSD slot.
3. Remove the M.2 2230 SSD mounting bracket from the palm-rest assembly.

Installing the M.2 2230 SSD in slot 1 (SSD1)

Prerequisites

If you are replacing a component, remove the existing component before performing the installation process.

About this task

The following images indicate the location of the M.2 2230 SSD in Slot 1 (SSD1) and provide a visual representation of the installation procedure.

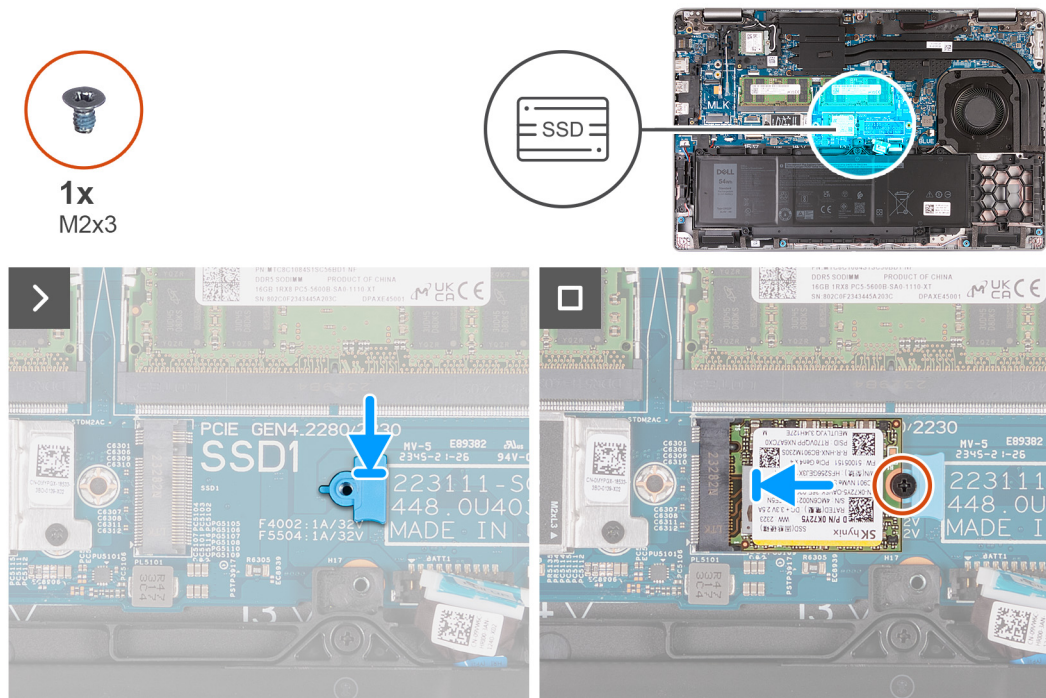

Figure 28. Installing the M.2 2230 SSD in slot 1

Steps

1. Place the M.2 2230 SSD mounting bracket on its slot on the palm-rest assembly.
2. Align the notch on the M.2 2230 SSD with the tab on the M.2 2230 SSD slot.
3. Slide the M.2 2230 SSD into the M.2 2230 SSD slot.
4. Replace the screw (M2x3) that secures the M.2 2230 SSD to the SSD mounting bracket and palm-rest assembly.

Next steps

1. Install the [base cover](#).
2. Install the [SIM card](#).
3. Follow the procedure in [After working inside your computer](#).

Removing the M.2 2280 SSD from slot 1 (SSD1)

Prerequisites

1. Follow the procedure in [Before working inside your computer](#).
2. Remove the [SIM card](#).
3. Remove the [base cover](#).

About this task

The following images indicate the location of the M.2 2280 SSD in slot 1 (SSD1) and provide a visual representation of the removal procedure.

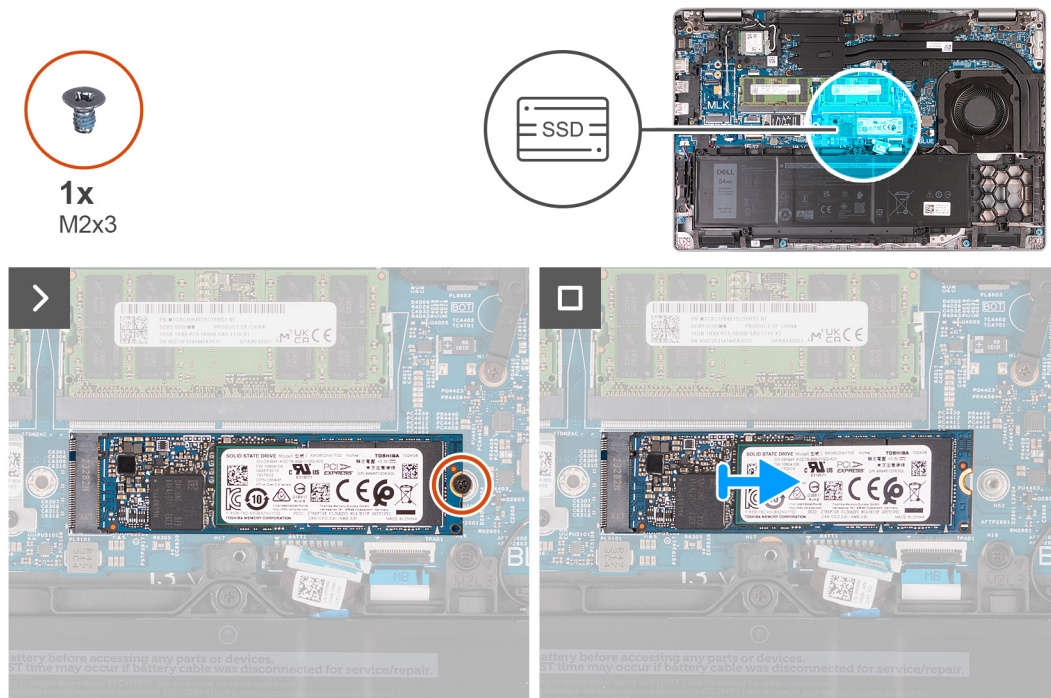

Figure 29. Removing the M.2 2280 SSD from slot 1

Steps

1. Remove the screw (M2x3) that secures the M.2 2280 SSD to the SSD bracket and palm-rest assembly.
2. Slide and lift the M.2 2280 SSD off the SSD slot.

Installing the M.2 2280 SSD in slot 1 (SSD1)

Prerequisites

If you are replacing a component, remove the existing component before performing the installation process.

About this task

The following images indicate the location of the M.2 2280 SSD in slot 1 (SSD1) and provide a visual representation of the installation procedure.

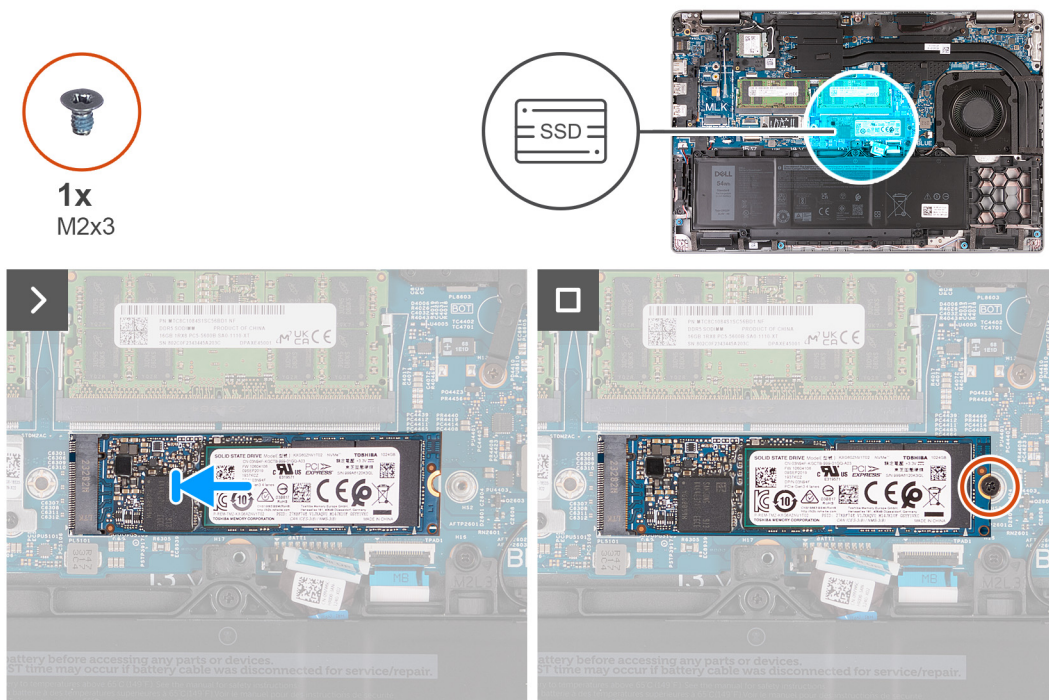

Figure 30. Installing the M.2 2280 SSD in slot 1

Steps

1. Align the notch on the M.2 2280 SSD with the tab on the M.2 2280 SSD slot.
2. Slide the M.2 2280 SSD into the M.2 2280 SSD slot.
3. Replace the screw (M2x3) that secures the M.2 2280 SSD to the SSD holder and palm-rest assembly.

Next steps

1. Install the [base cover](#).
2. Install the [SIM card](#).
3. Follow the procedure in [After working inside your computer](#).

Removing the M.2 2230 SSD from slot 2 (SSD2)

Prerequisites

1. Follow the procedure in [Before working inside your computer](#).
2. Remove the [SIM card](#).
3. Remove the [base cover](#).

About this task

The following images indicate the location of the M.2 2230 SSD in slot 2 (SSD2) and provide a visual representation of the removal procedure.

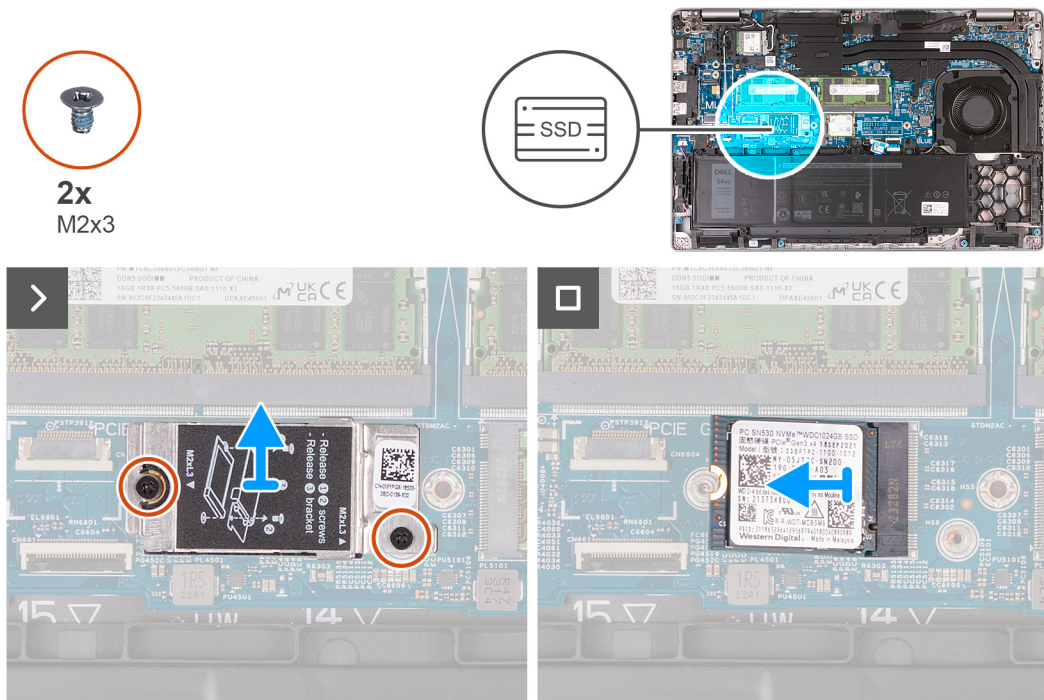

Figure 31. Removing the M.2 2230 SSD from slot 2

Steps

1. Remove the two screws (M2x3) that secure the SSD thermal shield to the palm-rest assembly.
2. Lift the SSD thermal shield off the palm-rest assembly.
3. Slide and lift the M.2 2230 SSD off the SSD slot.

Installing the M.2 2230 SSD in slot 2 (SSD2)

Prerequisites

If you are replacing a component, remove the existing component before performing the installation process.

About this task

The following images indicate the location of the M.2 2230 SSD (SSD2) in slot 2 and provide a visual representation of the installation procedure.

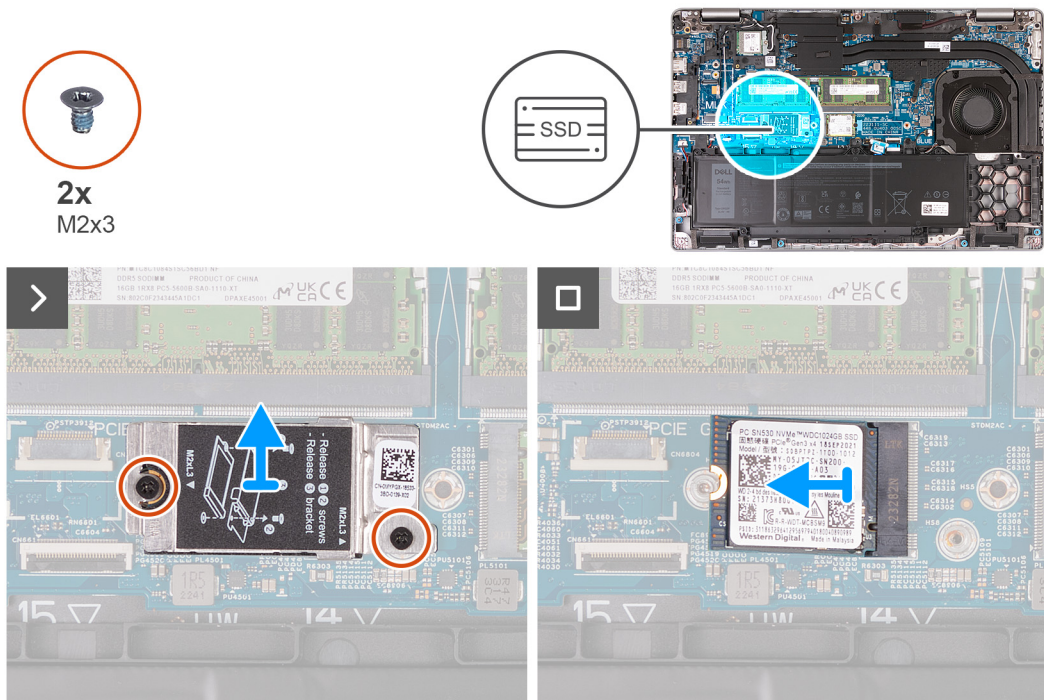

Figure 32. Installing the M.2 2230 SSD in slot 2

Steps

1. Align the notch on the M.2 2230 SSD with the tab on the M.2 2230 SSD slot.
2. Slide the M.2 2230 SSD into the M.2 2230 SSD slot.
3. Align the SSD thermal shield on the palm-rest assembly.
4. Replace the two screws (M2x3) that secure the SSD thermal shield to the palm-rest assembly.

Next steps

1. Install the [base cover](#).
2. Install the [SIM card](#).
3. Follow the procedure in [After working inside your computer](#).

Fan

Removing the fan

⚠ CAUTION: The information in this removal section is intended for authorized service technicians only.

Prerequisites

1. Follow the procedure in [Before working inside your computer](#).
2. Remove the [SIM card](#).
3. Remove the [base cover](#).

About this task

The following images indicate the location of the fan and provide a visual representation of the removal procedure.

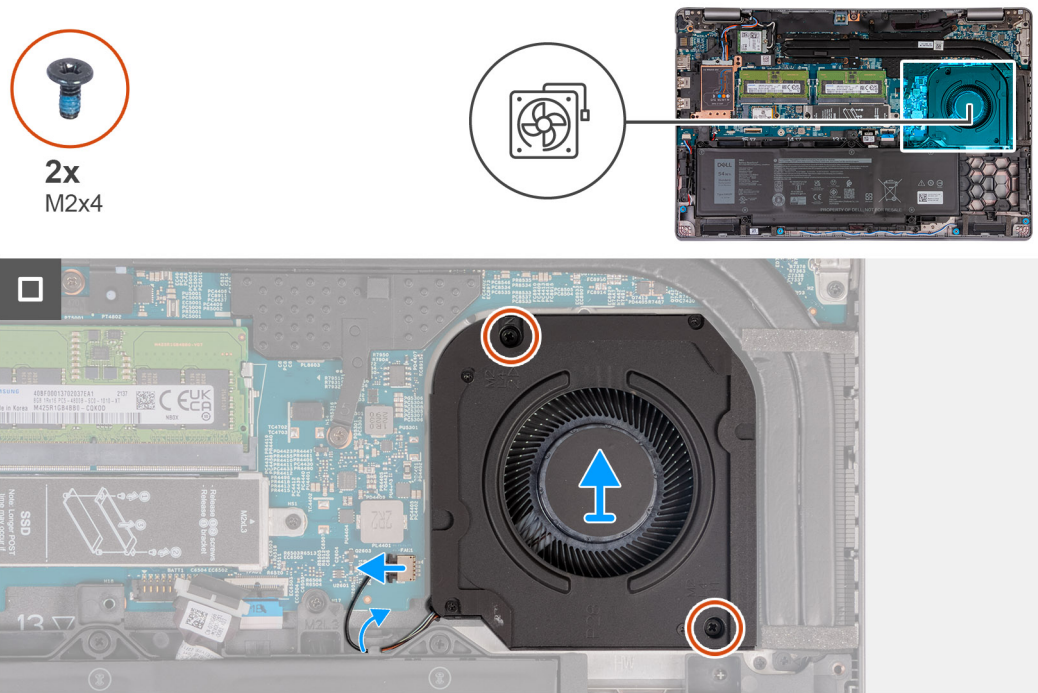

Figure 33. Removing the fan

Steps

1. Disconnect the fan cable from the fan-cable connector (FAN1) on the system board.
2. Remove the fan cable from the routing guides on the palm-rest assembly.
3. Remove the two screws (M2x4) that secure the fan to the palm-rest assembly.
4. Lift the fan off the palm-rest assembly.

Installing the fan

CAUTION: The information in this installation section is intended for authorized service technicians only.

Prerequisites

If you are replacing a component, remove the existing component before performing the installation process.

About this task

The following images indicate the location of the fan and provide a visual representation of the installation procedure.

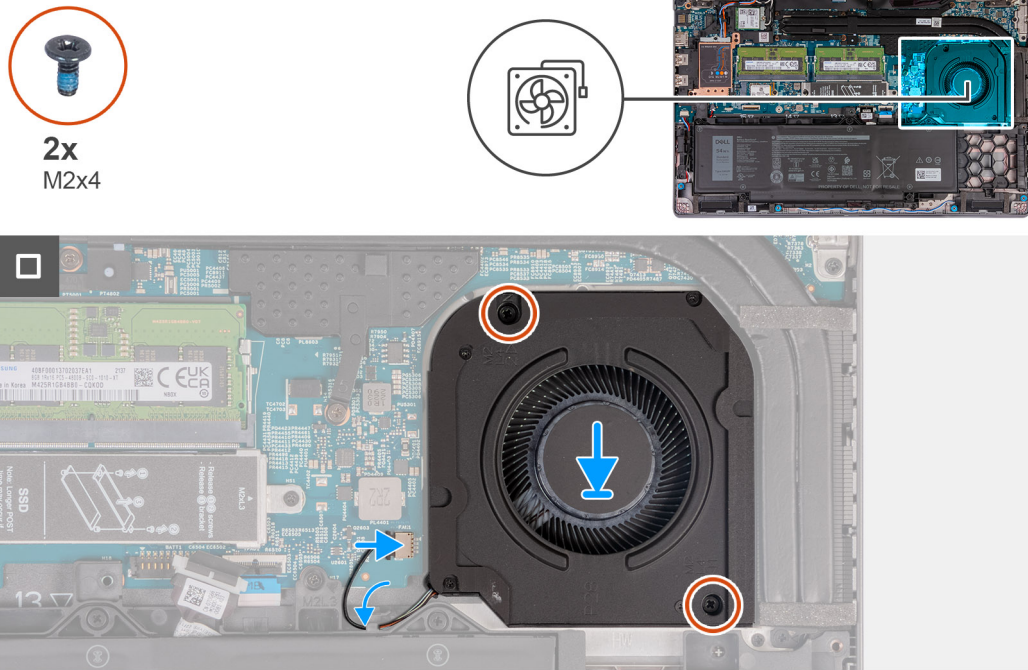

Figure 34. Installing the fan

Steps

1. Align the screw holes on the fan with the screw holes on the palm-rest assembly.
2. Replace the two screws (M2x4) that secure the fan to the palm-rest assembly.
3. Route the fan cable through the routing guides on the palm-rest assembly.
4. Connect the fan cable to the fan-cable connector (FAN1) on the system board.

Next steps

1. Install the [base cover](#).
2. Install the [SIM card](#).
3. Follow the procedure in [After working inside your computer](#).

Removing and installing Field Replaceable Units (FRUs)

The replaceable components in this chapter are Field Replaceable Units (FRUs).

CAUTION: The information in this section is intended for authorized service technicians only.

CAUTION: To avoid any potential damage to the component or loss of data, ensure that an authorized service technician replaces the Field Replaceable Units (FRUs).

CAUTION: Dell Technologies recommends that this set of repairs, if needed, to be conducted by trained technical repair specialists.

CAUTION: As a reminder, your warranty does not cover damages that may occur during FRU repairs that are not authorized by Dell Technologies.

NOTE: The images in this document may differ from your computer depending on the configuration you ordered.

Battery

Rechargeable Li-ion battery precautions

CAUTION:

- Exercise caution when handling rechargeable Li-ion batteries.
- Discharge the battery completely before removing it. Disconnect the AC power adapter from the computer and operate the computer solely on battery power—the battery is fully discharged when the computer no longer turns on when the power button is pressed.
- Do not crush, drop, mutilate, or penetrate the battery with foreign objects.
- Do not expose the battery to high temperatures, or disassemble battery packs and cells.
- Do not apply pressure to the surface of the battery.
- Do not bend the battery.
- Do not use tools of any kind to pry on or against the battery.
- Ensure any screws during the servicing of this product are not lost or misplaced, to prevent accidental puncture or damage to the battery and other computer components.
- If the battery gets stuck inside your computer as a result of swelling, do not try to release it as puncturing, bending, or crushing a rechargeable Li-ion battery can be dangerous. In such an instance, contact Dell technical support for assistance. See [Contact Support at Dell Support Site](#).
- Always purchase genuine batteries from [Dell Site](#) or authorized Dell partners and resellers.
- Swollen batteries should not be used and should be replaced and disposed properly. For guidelines on how to handle and replace swollen rechargeable Li-ion batteries, see [Handling swollen rechargeable Li-ion batteries](#).

Removing the battery

CAUTION: The information in this removal section is intended for authorized service technicians only.

Prerequisites

1. Follow the procedure in [Before working inside your computer](#).
2. Remove the [SIM card](#).
3. Remove the [base cover](#).

About this task

CAUTION: Removing the battery resets the BIOS setup settings to default. It is recommended that you note the BIOS setup settings before removing the battery.

The following images indicate the location of the battery and provide a visual representation of the removal procedure.

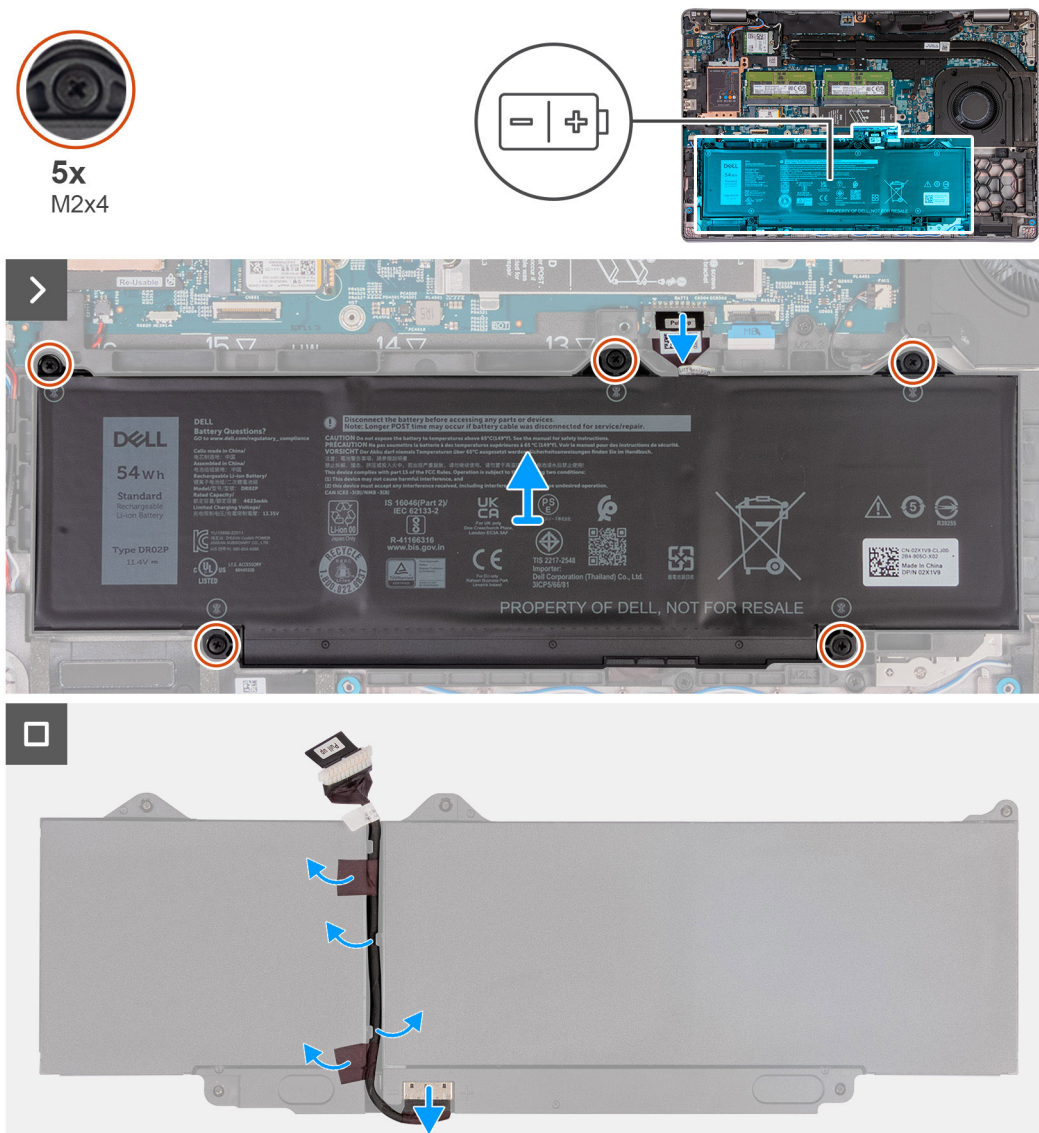

Figure 35. Removing the battery

Steps

1. Disconnect the battery cable from the battery cable connector (BATT1) on the system board (if not disconnected earlier).
2. Loosen the five captive screws (M2x4) that secure the battery to the palm-rest assembly.
3. Lift the battery off the palm-rest assembly.
4. Flip the battery and peel the tape that adheres the battery cable to the battery.
5. Remove the battery cable from the routing guides on the battery.
6. Disconnect the battery cable from the connector on the battery.

7. Remove the battery cable away from the battery.

Installing the battery

CAUTION: The information in this installation section is intended for authorized service technicians only.

Prerequisites

If you are replacing a component, remove the existing component before performing the installation procedure.

About this task

The following images indicate the location of the battery and provide a visual representation of the installation procedure.

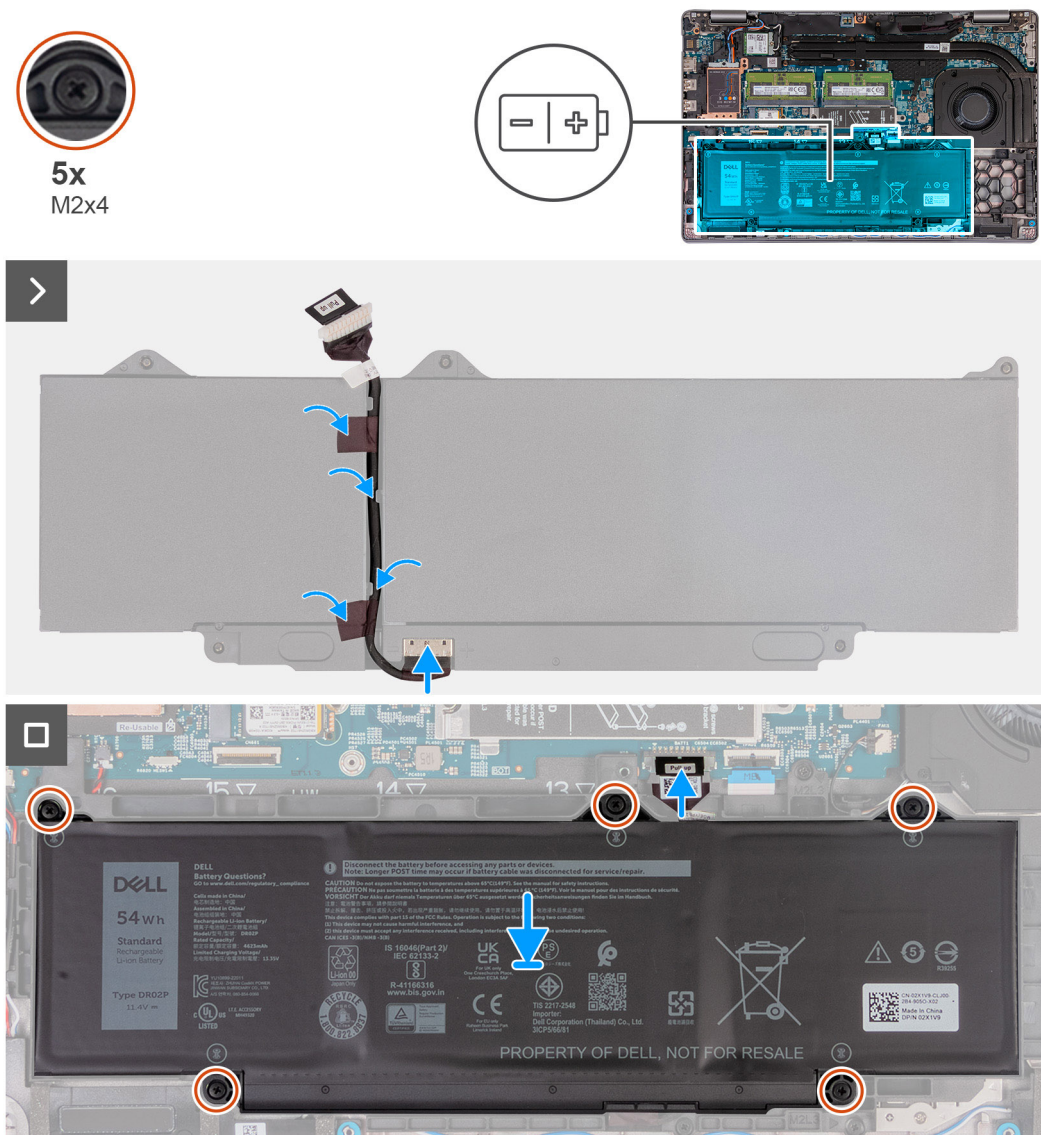

Figure 36. Installing the battery

Steps

1. Align and route the battery cable through the routing guides on the battery.
2. Adhere the tape that secures the battery cable to the battery.
3. Connect the battery cable to the connector on the battery.
4. Flip the battery.

5. Using the alignment posts, place the battery on the palm-rest assembly.
6. Align the screw holes on the battery with the screw holes on the palm-rest assembly.
7. Tighten the five captive screws (M2x4) that secure the battery to the palm-rest assembly.
8. Connect the battery cable to the battery cable connector (BATT1) on the system board.

Next steps

1. Install the [base cover](#).
2. Install the [SIM card](#).
3. Follow the procedure in [After working inside your computer](#).

Assembly-inner frame

Removing the assembly-inner frame

 **CAUTION:** The information in this removal section is intended for authorized service technicians only.

Prerequisites

1. Follow the procedure in [Before working inside your computer](#).
2. Remove the [SIM card](#).
3. Remove the [base cover](#).
4. Remove the [battery](#).
5. Remove the [4G WWAN card](#) or [5G WWAN card](#), as applicable.
6. Remove the [wireless card](#).

About this task

The following images indicate the location of the assembly-inner frame and provide a visual representation of the removal procedure.



12x
M2x3

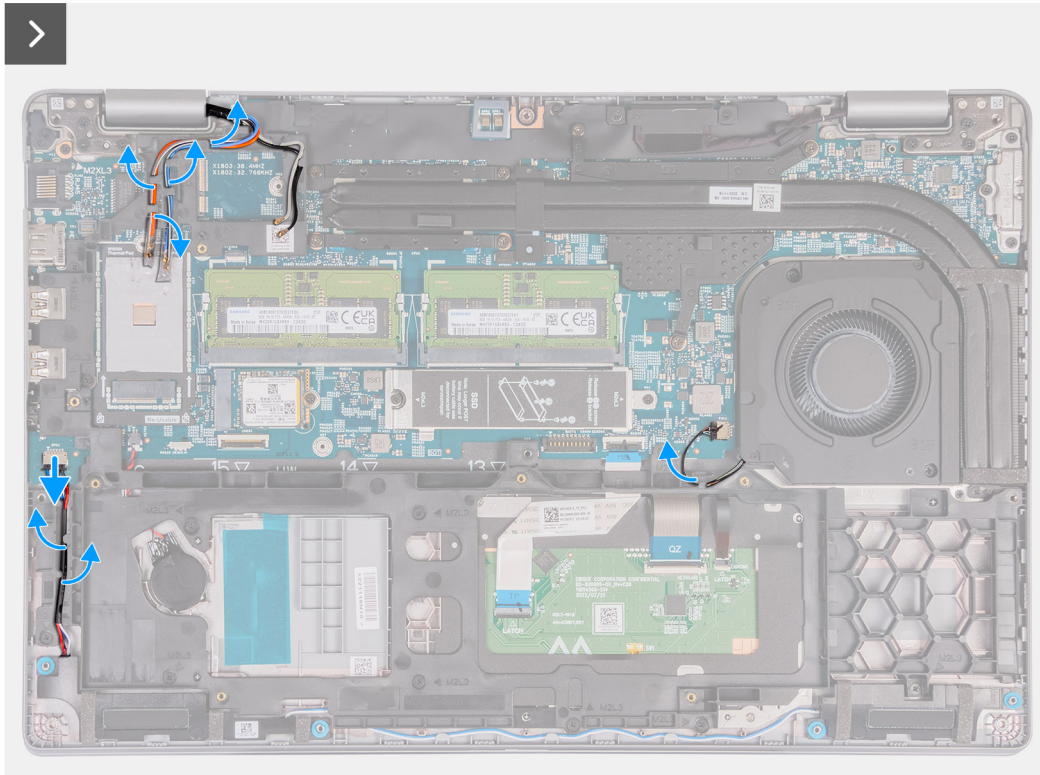
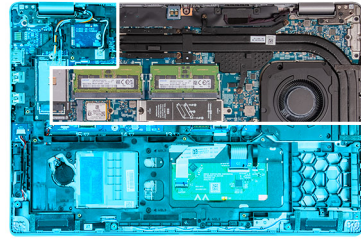

Figure 37. Removing the cables

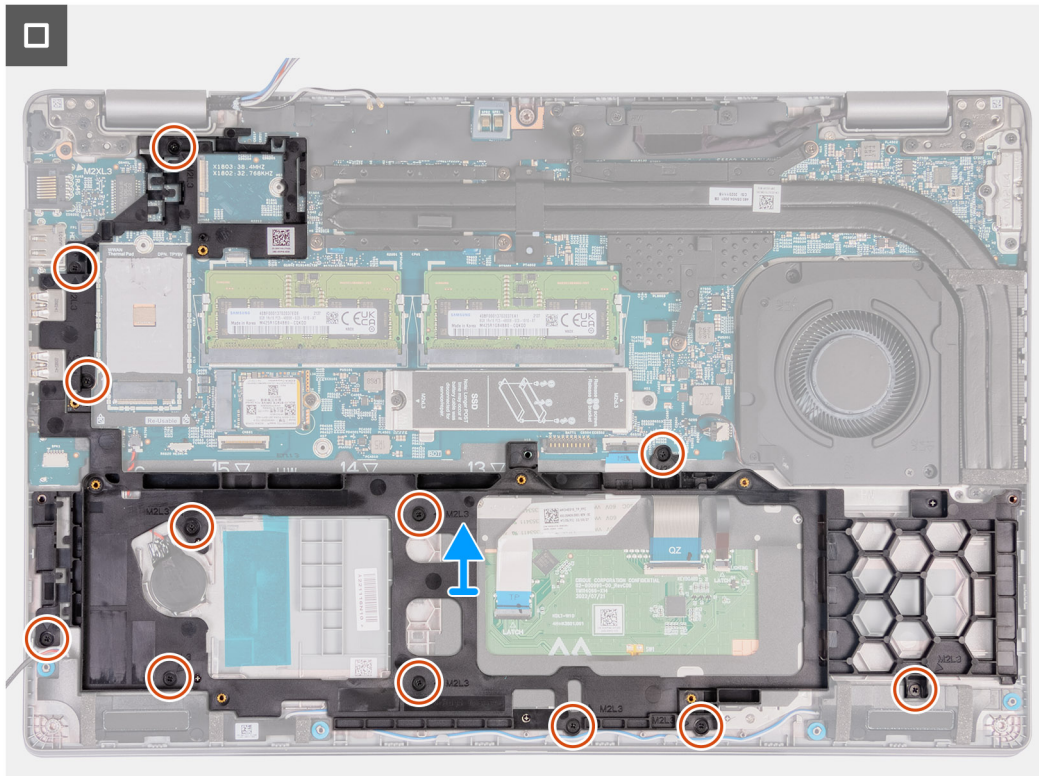

Figure 38. Removing the assembly-inner frame

Steps

1. Remove the WLAN and WWAN antenna cables from the routing guides on the palm-rest assembly.
2. Disconnect the speaker cable from the system board.
3. Remove the speaker cables from the routing guides on the palm-rest assembly.
4. Disconnect the fan cable from the system board.
5. Remove the fan cable from the routing guides on the palm-rest assembly.
6. Remove the twelve screws (M2x3) that secure the assembly-inner frame to the palm-rest assembly.
7. Remove the assembly-inner frame off the palm-rest assembly.

Installing the assembly-inner frame

CAUTION: The information in this installation section is intended for authorized service technicians only.

Prerequisites

If you are replacing a component, remove the existing component before performing the installation process.

About this task

The following images indicate the location of the assembly-inner frame and provide a visual representation of the installation procedure.



12x
M2x3

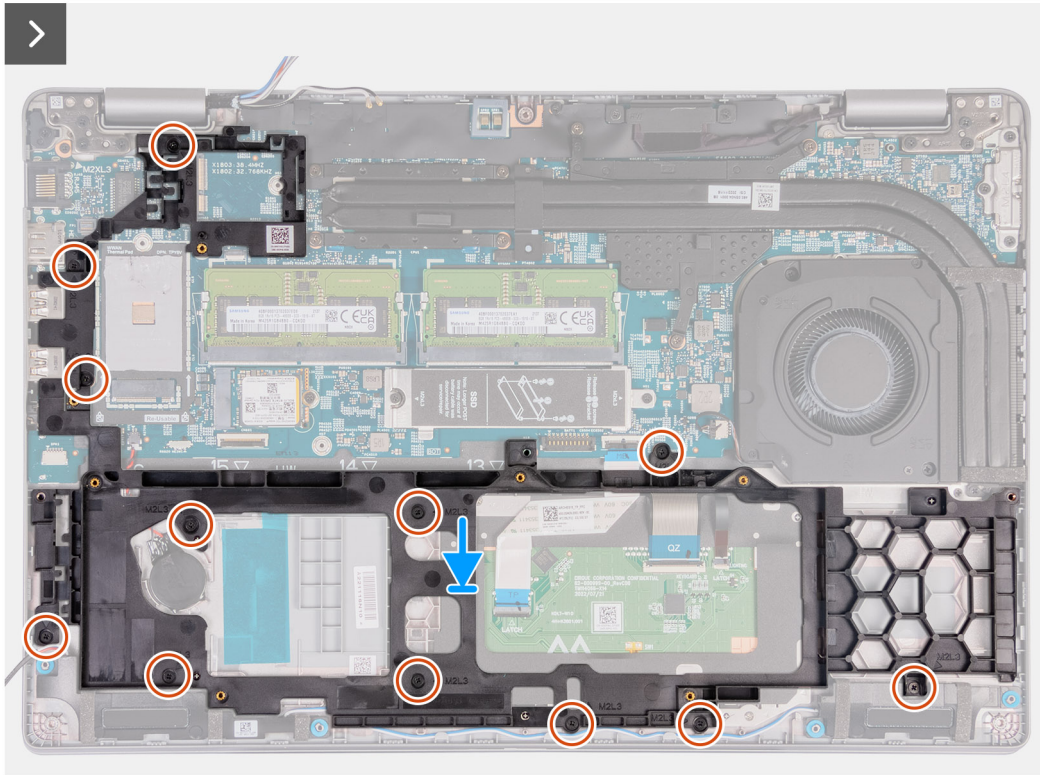
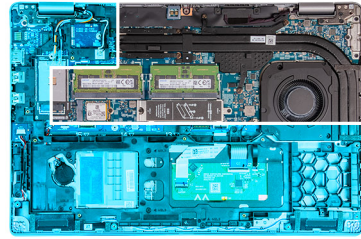

Figure 39. Installing the assembly-inner frame

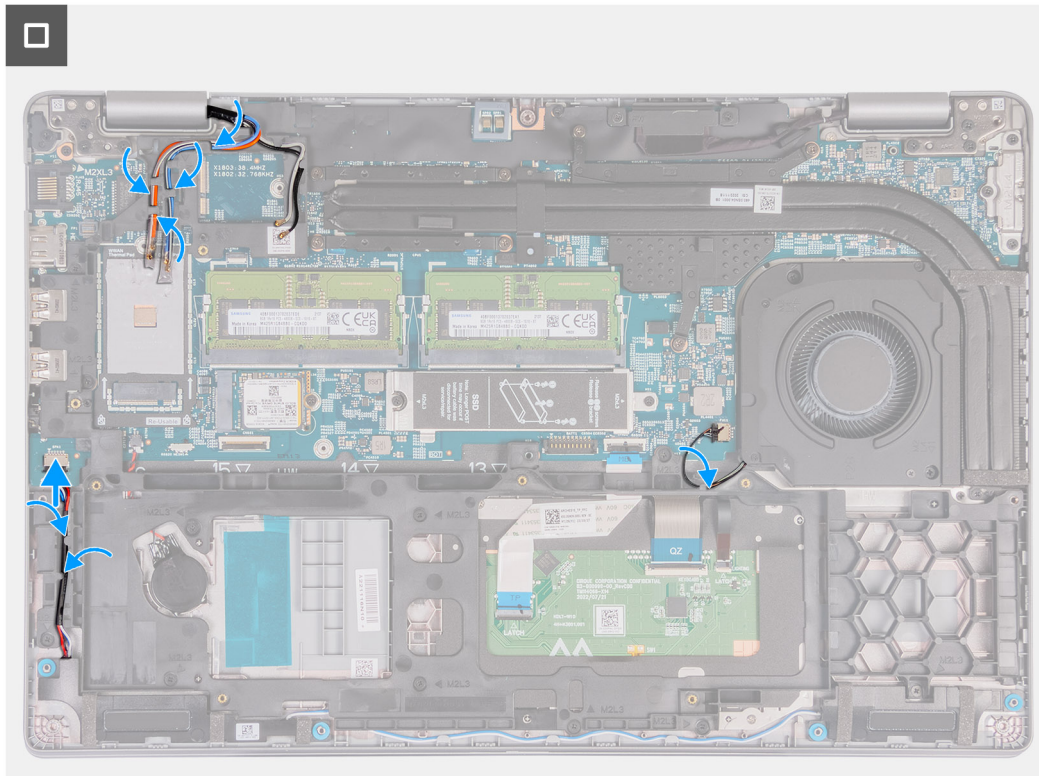

Figure 40. Routing the cables

Steps

1. Align the screw holes on the assembly-inner frame with the screw holes on the system board and the palm-rest assembly.
2. Replace the twelve screws (M2x3) that secure the assembly-inner frame to the palm-rest assembly.
3. Connect the speaker cable to the system board.
4. Route the speaker cables through the routing guides on the palm-rest assembly.
5. Connect the fan cable to the system board.
6. Route the fan cable through the routing guides on the palm-rest assembly.
7. Route the WLAN and WWAN antenna cables through the routing guides on the palm-rest assembly.

Next steps

1. Install the [wireless card](#).
2. Install the [4G WWAN card](#) or [5G WWAN card](#), as applicable.
3. Install the [battery](#).
4. Install the [base cover](#).
5. Install the [SIM card](#).
6. Follow the procedure in [After working inside your computer](#).

Touchpad

Removing the touchpad

⚠ CAUTION: The information in this removal section is intended for authorized service technicians only.

Prerequisites

1. Follow the procedure in [Before working inside your computer](#).

2. Remove the [SIM card](#).
3. Remove the [base cover](#).
4. Remove the [battery](#).
5. Remove the [4G WWAN card](#) or [5G WWAN card](#), as applicable.
6. Remove the [wireless card](#).
7. Remove the [assembly-inner frame](#).

About this task

The following images indicate the location of the touchpad and provide a visual representation of the removal procedure.

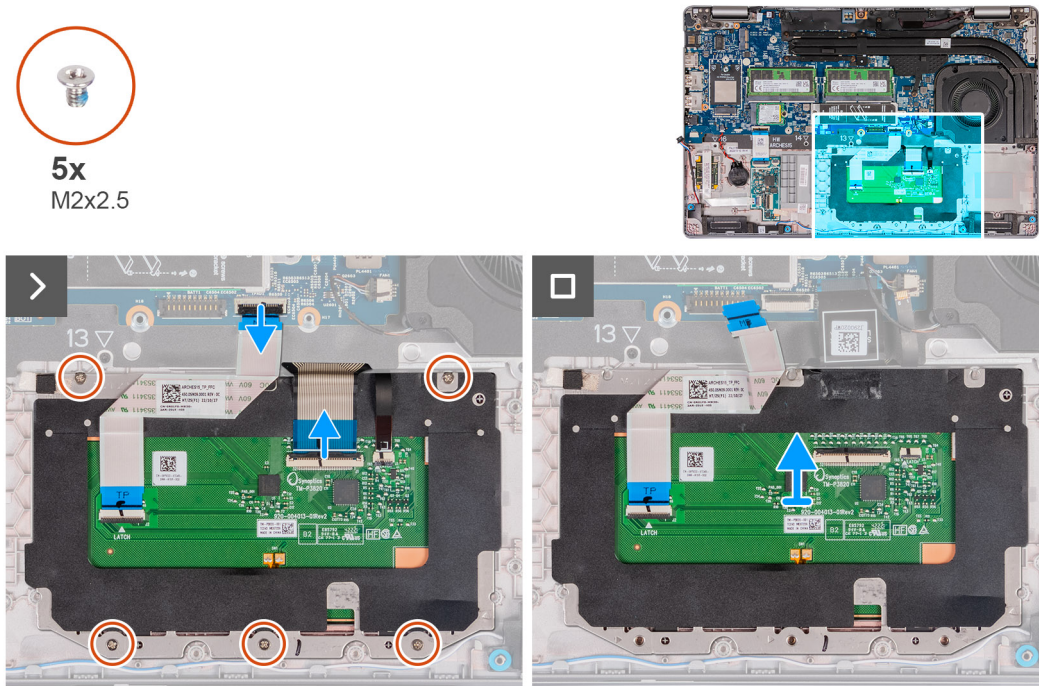

Figure 41. Removing the touchpad

Steps

1. Open the latch and disconnect the touchpad cable from the touchpad cable connector (TPAD1) on the system board. Peel the cable back to locate the screw located under the cable.
2. Open the latch and disconnect the keyboard cable from the connector on the touchpad. Peel the keyboard cable from the touchpad.
3. Open the latch and disconnect the keyboard-backlight cable from the connector on the touchpad.
 - CAUTION:** The latch for the backlight cable is opposite of the latch for the keyboard cable. Ensure you are lifting the correct part of the connector to avoid damage to the cable socket.
4. Remove the six screws (M2x2.5) that secure the touchpad to the palm-rest assembly.
5. Lift the touchpad off the palm-rest assembly.

Installing the touchpad

CAUTION: The information in this installation section is intended for authorized service technicians only.

Prerequisites

If you are replacing a component, remove the existing component before performing the installation process.

About this task

The following images indicate the location of the touchpad and provide a visual representation of the installation procedure.

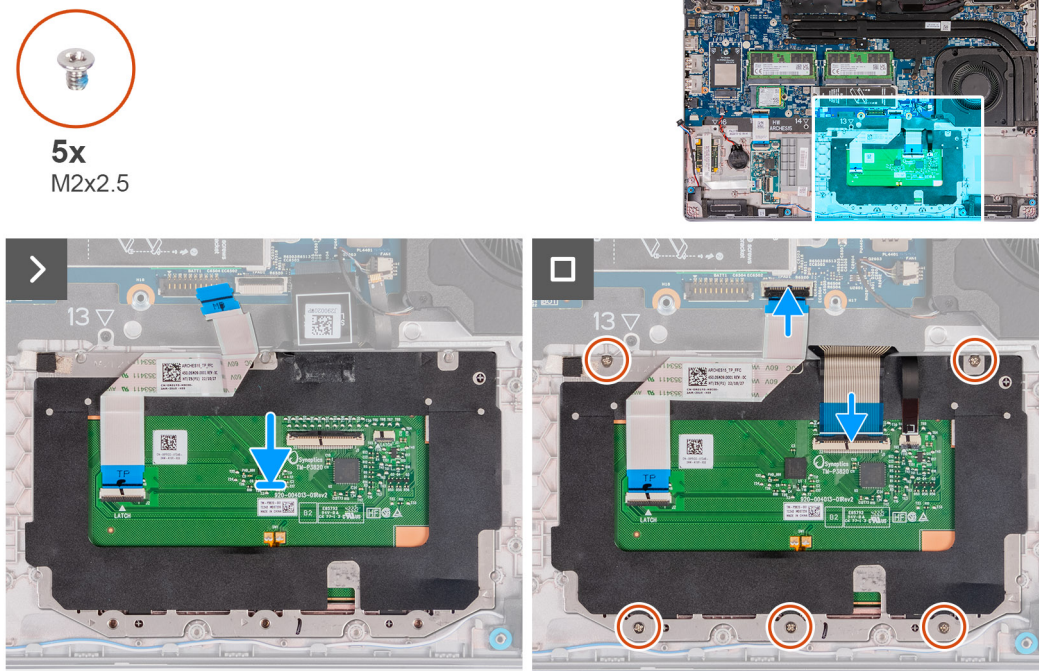

Figure 42. Installing the touchpad

Steps

1. Place the touchpad into its slot on the palm-rest assembly.
2. Align the screw holes on the touchpad to the screw holes on the palm-rest assembly.
3. Replace the six screws (M2x2.5) that secure the touchpad to the palm-rest assembly.
4. Connect the keyboard-backlight cable to the connector on the touchpad and close the latch to secure the cable.

CAUTION: The latch for the backlight cable is opposite of the latch for the keyboard cable. Ensure you are closing the correct part of the connector to avoid damage to the cable socket.

5. Connect the keyboard cable to the connector on the touchpad and close the latch to secure the cable.
6. Connect the touchpad cable to the connector on the system board and close latch to secure the cable.

Next steps

1. Install the [assembly inner frame](#).
2. Install the [wireless card](#).
3. Install the [4G WWAN card](#) or [5G WWAN card](#), as applicable.
4. Install the [battery](#).
5. Install the [base cover](#).
6. Install the [SIM card](#).
7. Follow the procedure in [After working inside your computer](#).

Speakers

Removing the speakers

CAUTION: The information in this removal section is intended for authorized service technicians only.

Prerequisites

1. Follow the procedure in [Before working inside your computer](#).
2. Remove the [SIM card](#).
3. Remove the [base cover](#).
4. Remove the [wireless card](#).
5. Remove the [4G WWAN card](#) or [5G WWAN card](#), as applicable.
6. Remove the [assembly-inner frame](#).

About this task

The following images indicate the location of the speakers and provide a visual representation of the removal procedure.

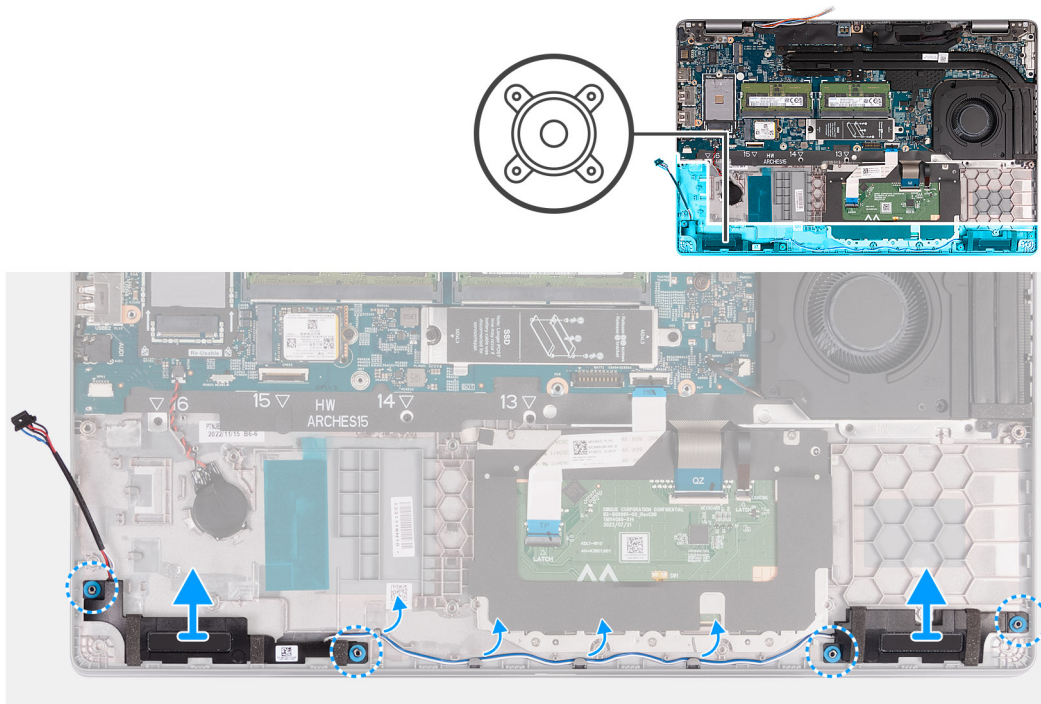

Figure 43. Removing the speakers

Steps

1. Remove the speaker cables from the routing guides on the palm-rest assembly.
2. Lift the right and left speakers, along with its cable, off the palm-rest assembly.

Installing the speakers

CAUTION: The information in this installation section is intended for authorized service technicians only.

Prerequisites

If you are replacing a component, remove the existing component before performing the installation process.

About this task

The following images indicate the location of the speakers and provide a visual representation of the installation procedure.

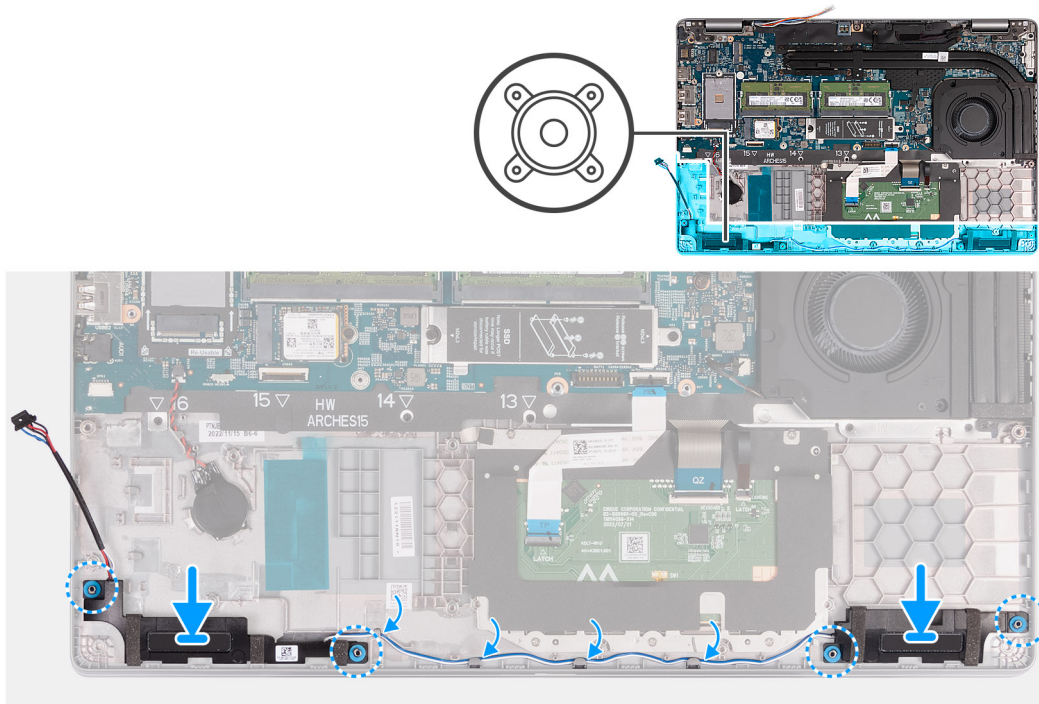

Figure 44. Installing the speakers

Steps

1. Using the alignment posts, place the left and right speakers into their slots on the palm-rest assembly.
 2. Route the speaker cable through the routing guides on the palm-rest assembly.
- i NOTE:** Ensure that the rubber grommets are seated into the slot and installed on the speakers properly.

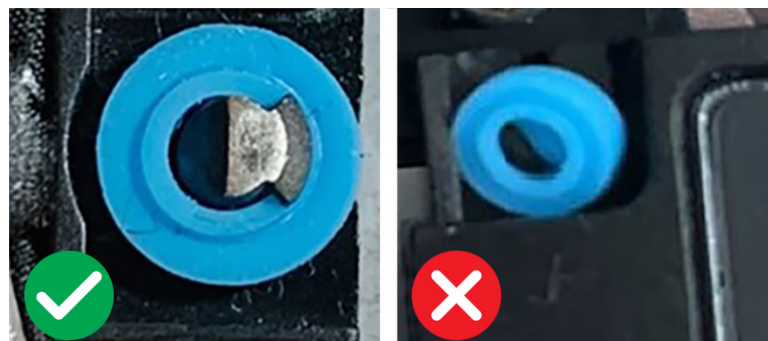

Figure 45. Rubber grommets

3. Connect the speaker cable to the system board.

Next steps

1. Install the [assembly-inner frame](#).
2. Install the [4G WWAN card](#) or [5G WWAN card](#), as applicable.
3. Install the [wireless card](#).
4. Install the [base cover](#).
5. Install the [SIM card](#).
6. Follow the procedure in [After working inside your computer](#).

Coin-cell battery

Removing the coin-cell battery

CAUTION: The information in this removal section is intended for authorized service technicians only.

Prerequisites

1. Follow the procedure in [Before working inside your computer](#).

CAUTION: Removing the coin-cell battery resets the BIOS setup program's settings to default. It is recommended that you note the BIOS setup program's settings before removing the coin-cell battery.

2. Remove the [SIM card](#).
3. Remove the [base cover](#).
4. Remove the [wireless card](#).
5. Remove the [4G WWAN card](#) or [5G WWAN card](#), as applicable.
6. Remove the [battery](#).
7. Remove the [assembly-inner frame](#).

About this task

The following images indicate the location of the coin-cell battery and provide a visual representation of the removal procedure.

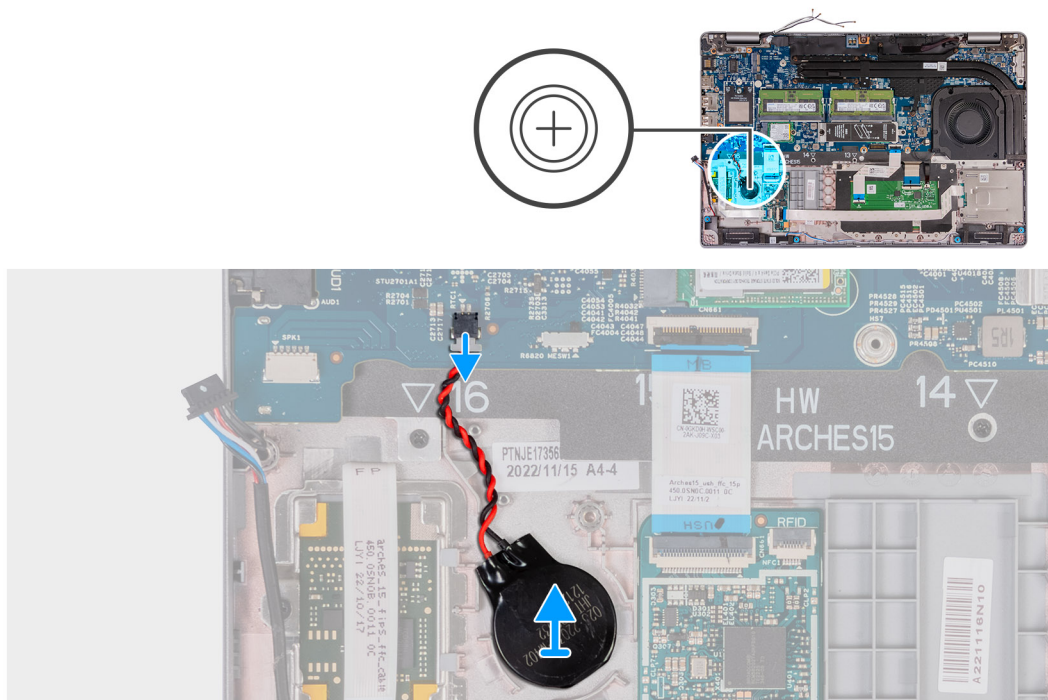

Figure 46. Removing the coin-cell battery

Steps

1. Disconnect the coin-cell battery cable from the coin-cell battery connector (RTC1) on the system board.
2. Peel the coin-cell battery, along with its cable, off the palm-rest assembly.

Installing the coin-cell battery

CAUTION: The information in this installation section is intended for authorized service technicians only.

Prerequisites

If you are replacing a component, remove the existing component before performing the installation procedure.

About this task

The following images indicate the location of the coin-cell battery and provide a visual representation of the installation procedure.

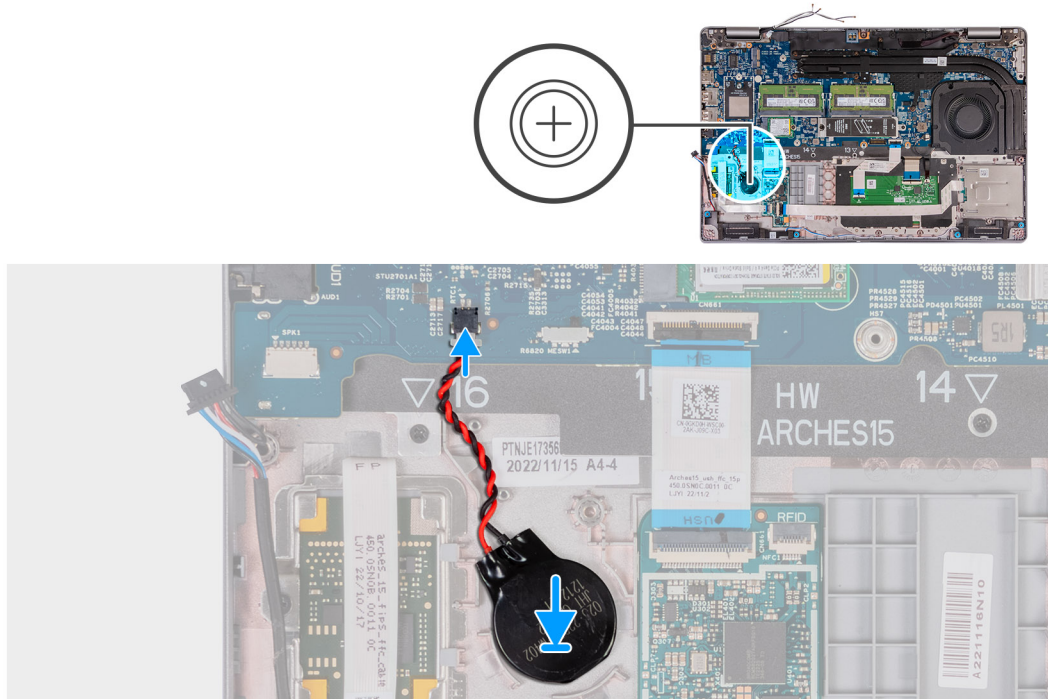

Figure 47. Installing the coin-cell battery

Steps

1. Adhere the coin-cell battery on to the coin-cell battery slot on the palm-rest assembly.
2. Connect the coin-cell battery cable to the coin-cell battery cable connector (RTC1) on the system board.

Next steps

1. Install the [assembly-inner frame](#).
2. Install the [battery](#).
3. Install the [4G WWAN card](#) or [5G WWAN card](#), as applicable.
4. Install the [wireless card](#).
5. Install the [base cover](#).
6. Install the [SIM card](#).
7. Follow the procedure in [After working inside your computer](#).

Heat sink

Removing the heat sink (Discrete GPU)

⚠ CAUTION: The information in this removal section is intended for authorized service technicians only.

Prerequisites

1. Follow the procedure in [Before working inside your computer](#).

2. Remove the [SIM card](#).
3. Remove the [base cover](#).

About this task

- NOTE:** The heat sink may become hot during normal operation. Allow sufficient time for the heat sink to cool before you touch it.
- NOTE:** For maximum cooling of the processor, do not touch the heat transfer areas on the heat sink. The oils in your skin can reduce the heat transfer capability of the thermal grease.

The following images indicate the location of the heat sink and provide a visual representation of the removal procedure.

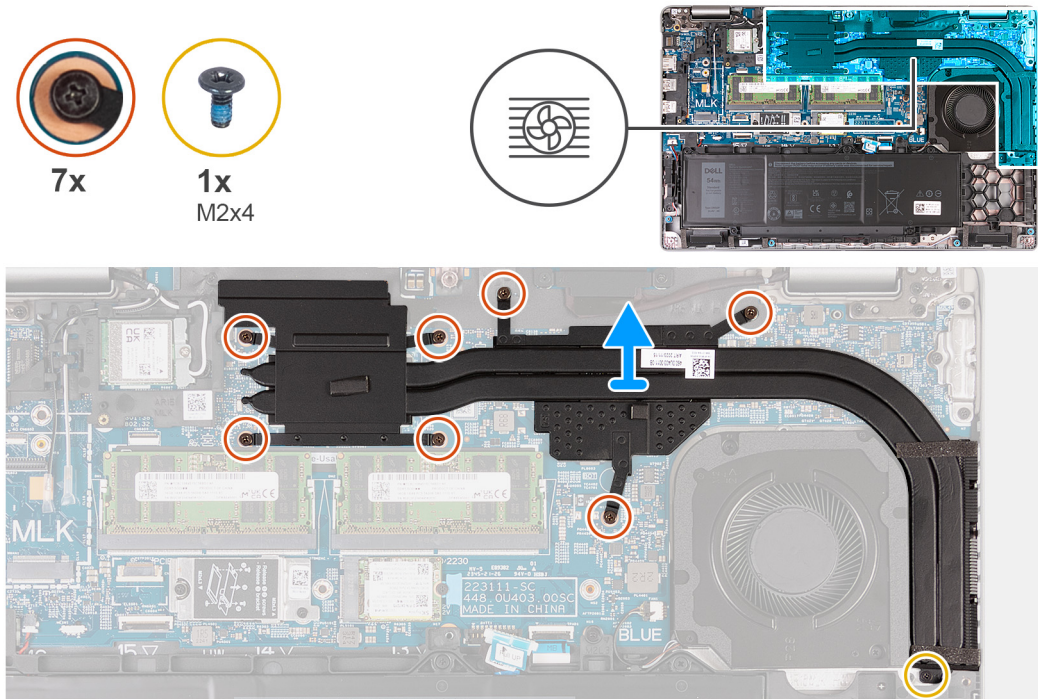

Figure 48. Removing the heat sink (Discrete GPU)

Steps

1. Disconnect the fan cable from the system board and remove the fan cable from the routing guides on the assembly-inner frame.
2. Loosen the seven captive screws that secure the heat sink to the system board.
 - NOTE:** Loosen the captive screws in the reverse sequential order mentioned on the heat sink [7 > 6 > 5 > 4 > 3 > 2 > 1].
 - NOTE:** The number of screws varies depending on the configuration ordered.
3. Remove the screw (M2x4) that secures the heat sink to the system board.
4. Lift the heat sink off the system board.

Installing the heat sink (Discrete GPU)

CAUTION: The information in this installation section is intended for authorized service technicians only.

Prerequisites

If you are replacing a component, remove the existing component before performing the installation process.

About this task

NOTE: If either the system board or the heat sink is replaced, use the thermal grease that is provided in the kit to ensure that the thermal conductivity is achieved.

The following images indicate the location of the heat sink and provide a visual representation of the installation procedure.

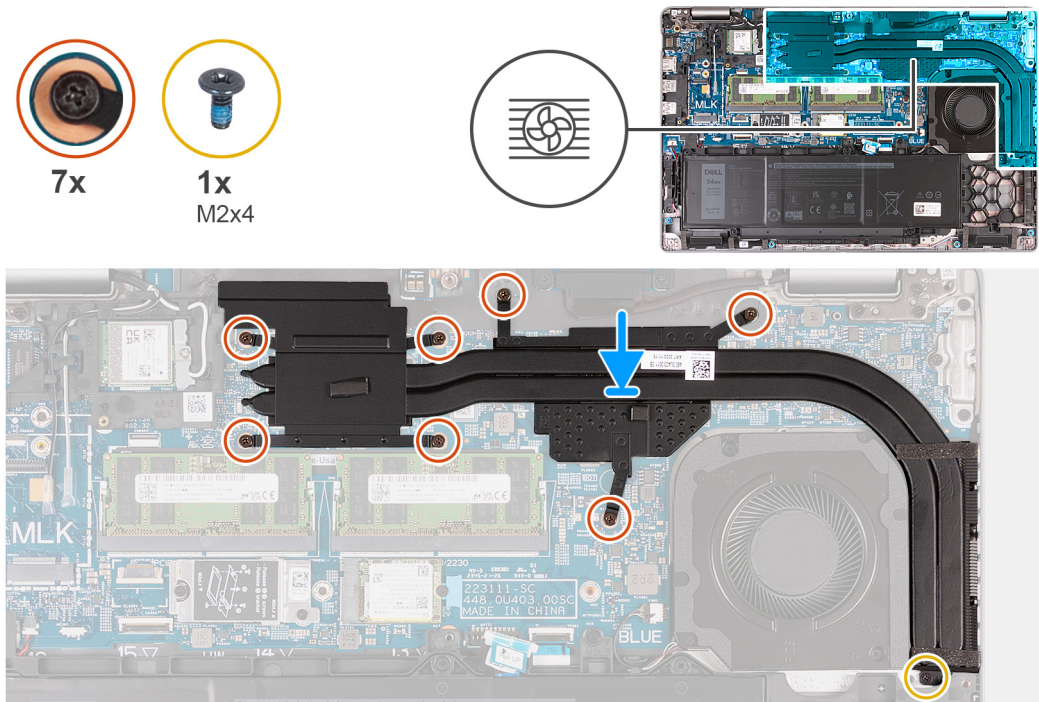

Figure 49. Installing the heat sink (Discrete GPU)

Steps

1. Place the heat sink on the system board.
2. Tighten the seven captive screws that secure the heat sink to the system board.
 - NOTE:** Tighten the captive screws in the sequential order mentioned on the heat sink [1 > 2 > 3 > 4 > 5 > 6 > 7].
 - NOTE:** The number of screws varies depending on the configuration ordered.
3. Replace the screw (M2x4) that secures the heat sink to the system board.
4. Route the fan cable through the routing guide on the assembly-inner frame and connect the fan cable to the system board.

Next steps

1. Install the [base cover](#).
2. Install the [SIM card](#).
3. Follow the procedure in [After working inside your computer](#).

Removing the heat sink (Integrated GPU)

CAUTION: The information in this installation section is intended for authorized service technicians only.

Prerequisites

1. Follow the procedure in [Before working inside your computer](#).
2. Remove the [SIM card](#).
3. Remove the [base cover](#).

About this task

- NOTE:** The heat sink may become hot during normal operation. Allow sufficient time for the heat sink to cool before you touch it.
- NOTE:** For maximum cooling of the processor, do not touch the heat transfer areas on the heat sink. The oils in your skin can reduce the heat transfer capability of the thermal grease.

The following images indicate the location of the heat sink and provide a visual representation of the removal procedure.

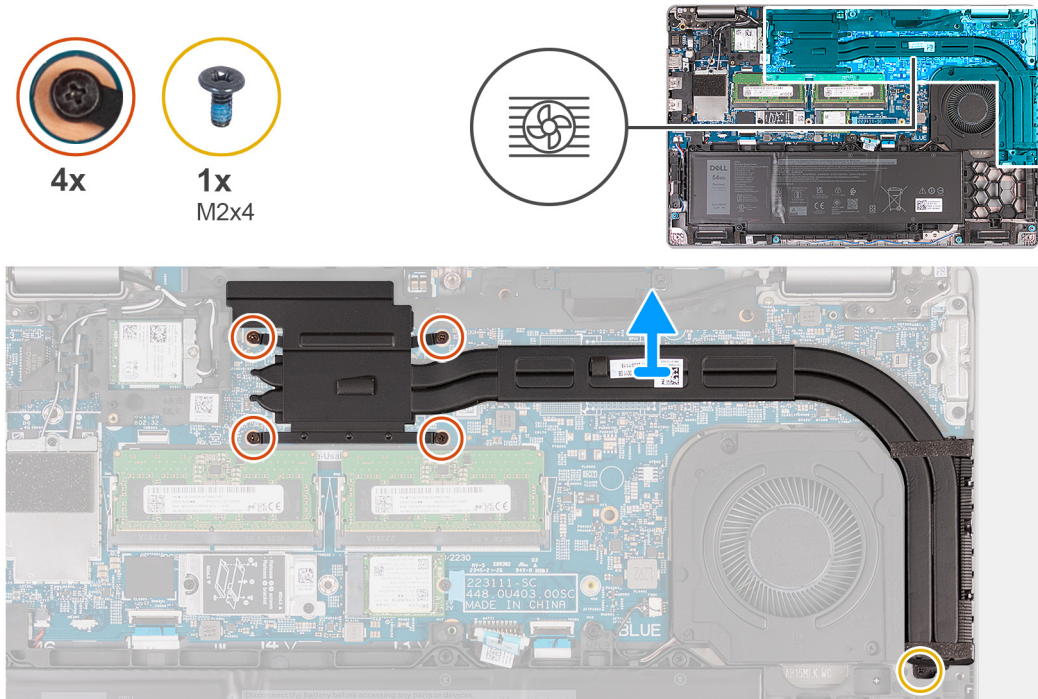

Figure 50. Removing the heat sink (Integrated GPU)

Steps

1. Disconnect the fan cable from the system board and remove the fan cable from the routing guides on the assembly-inner frame.
2. Loosen the four captive screws that secure the heat sink to the system board.
 - NOTE:** Loosen the captive screws in the reverse sequential order mentioned on the heat sink [4 > 3 > 2 > 1].
 - NOTE:** The number of screws varies depending on the configuration ordered.
3. Remove the screw (M2x4) that secures the heat sink to the system board.
4. Lift the heat sink from the system board.

Installing the heat sink (Integrated GPU)

CAUTION: The information in this installation section is intended for authorized service technicians only.

Prerequisites

If you are replacing a component, remove the existing component before performing the installation process.

About this task

- NOTE:** If either the system board or the heat sink is replaced, use the thermal grease that is provided in the kit to ensure that the thermal conductivity is achieved.

The following images indicate the location of the heat sink and provide a visual representation of the installation procedure.

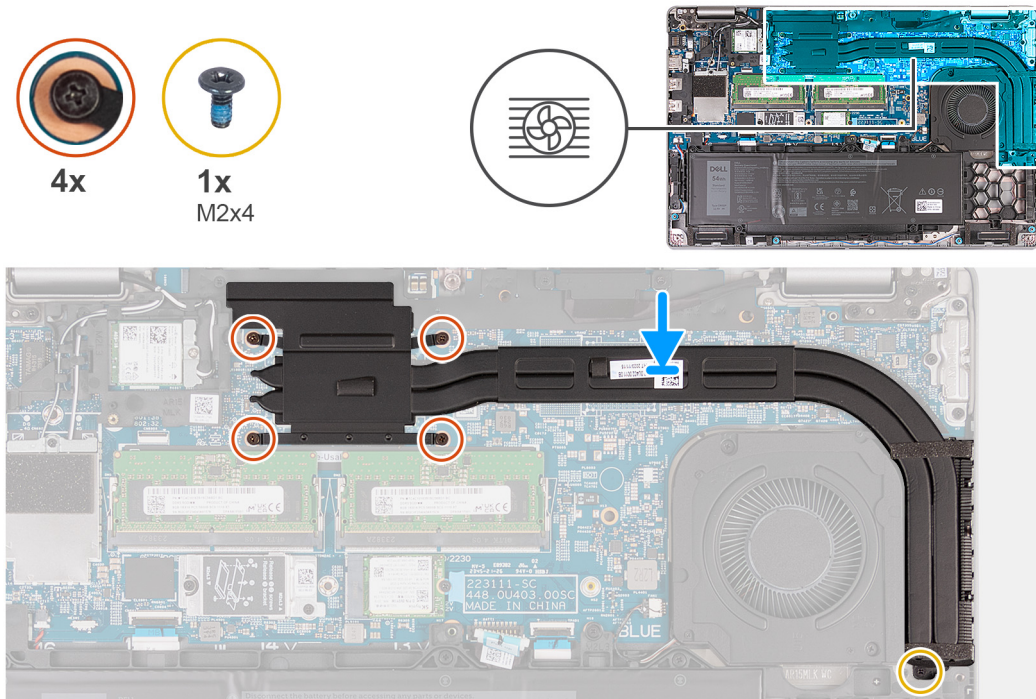

Figure 51. Installing the heat sink (Integrated GPU)

Steps

1. Place the heat sink on the system board.
2. Tighten the four captive screws that secure the heat sink to the system board.
 - i** **NOTE:** Tighten the captive screws in the sequential order mentioned on the heat sink [1 > 2 > 3 > 4].
 - i** **NOTE:** The number of screws varies depending on the configuration ordered.
3. Replace the screw (M2x4) that secures the heat sink to the system board.
4. Route the fan cable through the routing guide on the assembly-inner frame and connect the fan cable to the system board.

Next steps

1. Install the [base cover](#).
2. Install the [SIM card](#).
3. Follow the procedure in [After working inside your computer](#).

System board

Removing the system board

⚠ CAUTION: The information in this removal section is intended for authorized service technicians only.

Prerequisites

1. Follow the procedure in [Before working inside your computer](#).
2. Remove the [SIM card](#).
3. Remove the [base cover](#).
4. Remove the [4G WWAN card](#) or [5G WWAN card](#), as applicable.

5. Remove the [wireless card](#).
6. Remove the [memory modules](#).
7. Remove the [M.2 2230](#) or [M.2 2280](#) SSD from slot 1, as applicable.
8. Remove the [M.2 2230](#) SSD from slot 2, if applicable.
9. Remove the [heat sink \(discrete GPU\)](#) or [heat sink \(integrated GPU\)](#), as applicable.
10. Remove the [battery](#).
11. Remove the [assembly-inner frame](#).

About this task

The following images indicate the system board connectors.

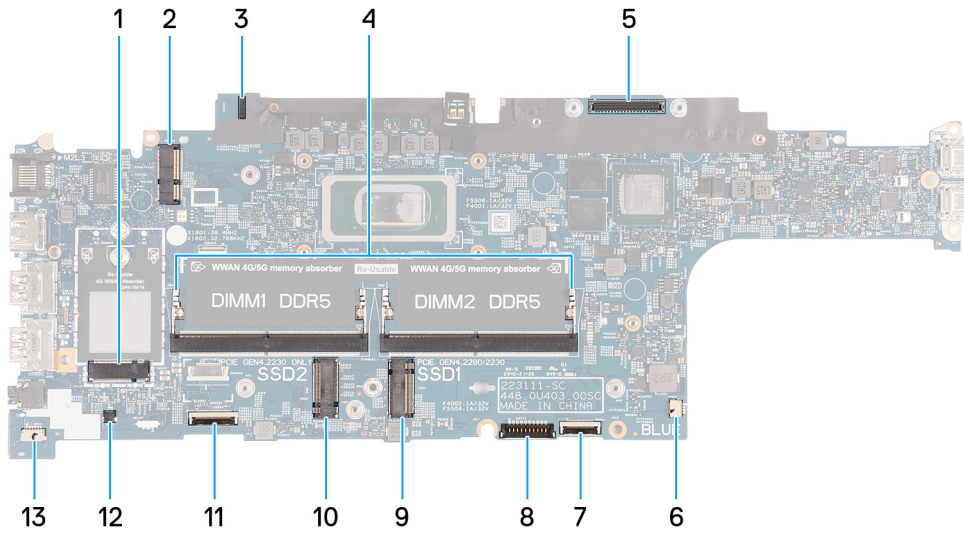

Figure 52. System board connectors

- | | |
|-------------------------------------|--|
| 1. WWAN-card connector (WWAN1) | 2. Wireless-card connector (WLAN1) |
| 3. Sensor board-cable connector | 4. Memory modules (DIMM1 and DIMM2) |
| 5. Display-cable connector (LCD1) | 6. System-fan connector (FAN1) |
| 7. Touchpad-cable connector (TPAD1) | 8. Battery-cable connector (BATT1) |
| 9. Solid-state drive Slot 1 (SSD1) | 10. Solid-state drive Slot 2 (SSD2) |
| 11. USH-cable connector | 12. Coin-cell battery cable connector (RTC1) |
| 13. Speaker-cable connector (SPK1) | |

The following images indicate the location of the system board and provide a visual representation of the removal procedure.

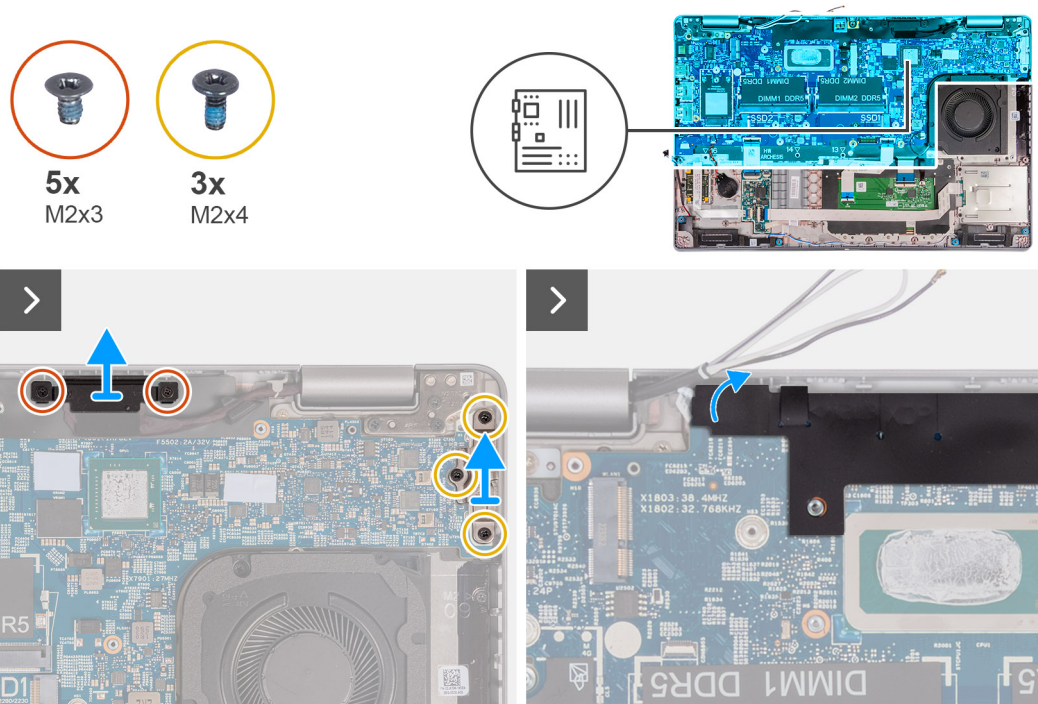

Figure 53. Removing the screws

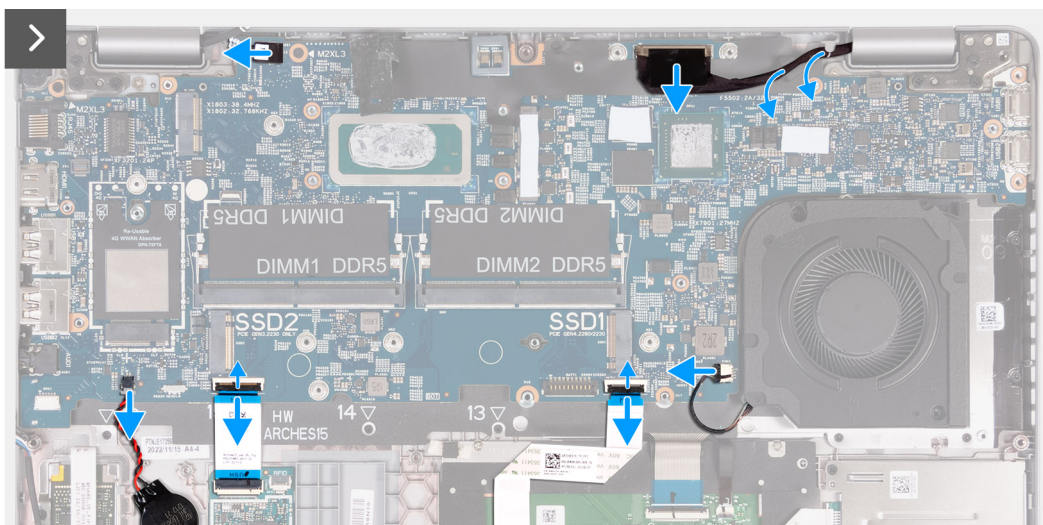

Figure 54. Disconnecting the system board cables

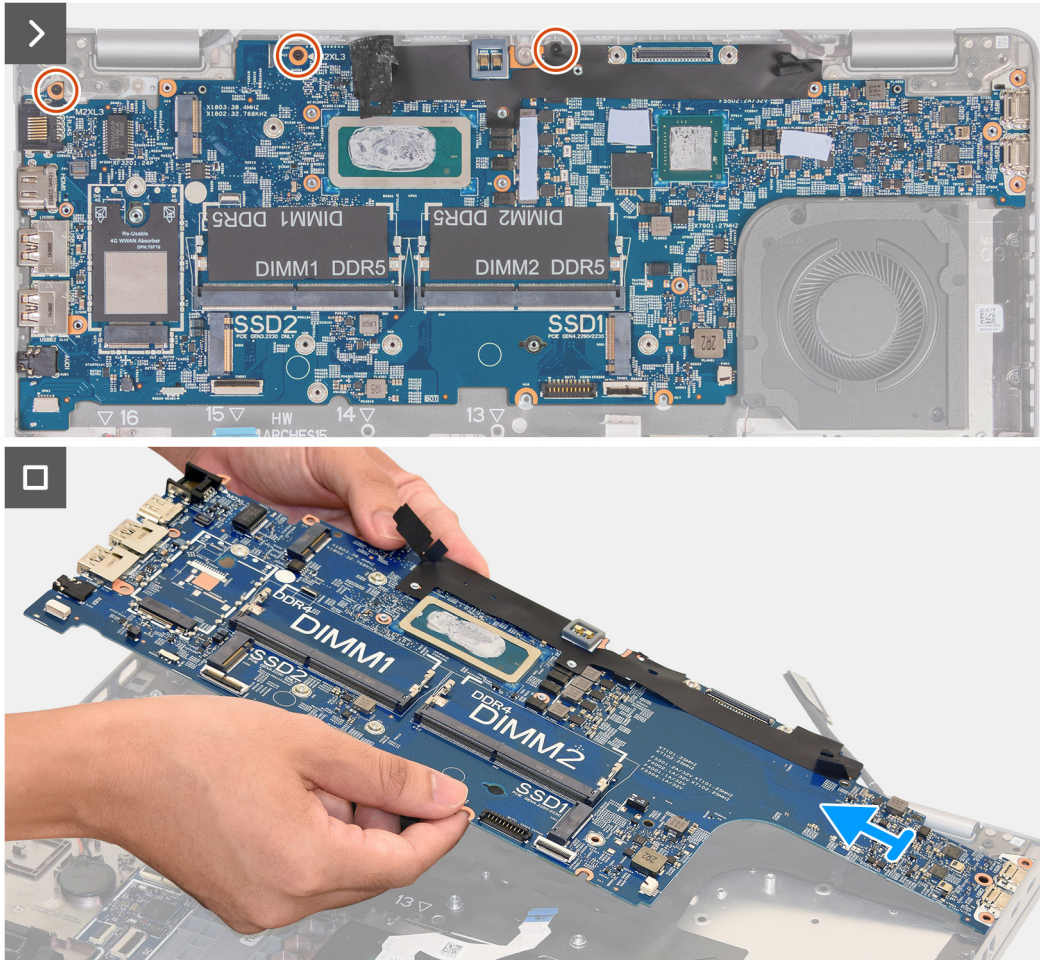

Figure 55. Removing the system board

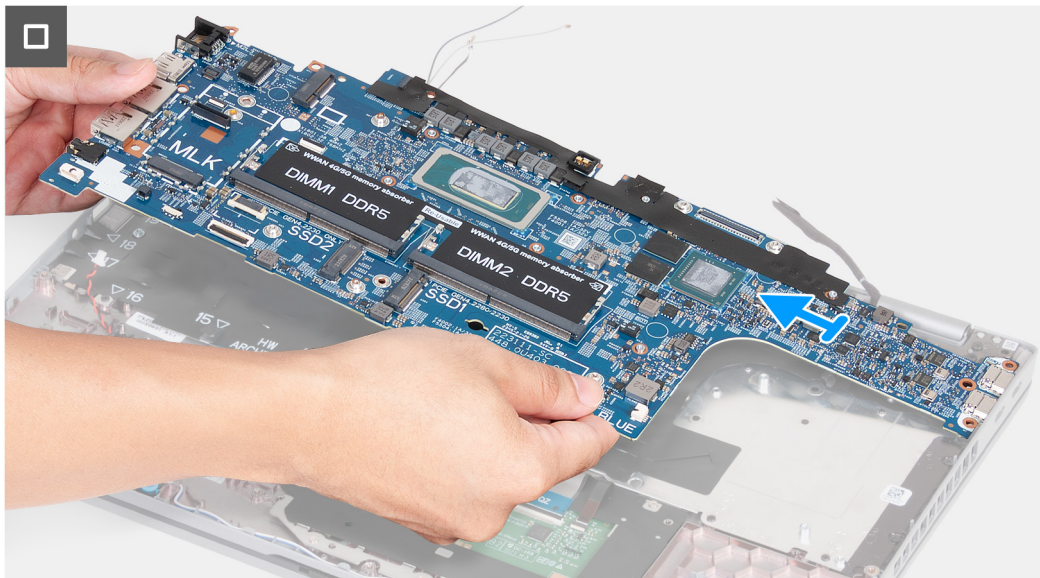

Figure 56. Removing the system board

Steps

1. Remove the two screws (M2x3) that secure the display-cable bracket to the palm-rest assembly.
2. Lift the display-cable bracket off the palm-rest assembly.

3. Remove the three screws (M2x4) that secure the Type-C bracket to the palm-rest assembly.
4. Lift the Type-C bracket off the palm-rest assembly.
5. Disconnect the fingerprint reader cable from the system board.
6. Lift the black flap near the antenna cables and uncover the sensor board-cable.
7. Disconnect the sensor board-cable from the connector on the system board.
8. Disconnect the display cable from the display cable connector (LCD1) on the system board.
9. Remove the display cable from the routing guides on the system board.
10. Open the latch and disconnect the touchpad cable from the touchpad cable connector (TPAD1) on the system board.
11. Open the latch and disconnect the USH cable from the USH module.
12. Peel the coin-cell battery from the palm-rest assembly, leaving the cable connected to the system board.
13. Remove the two screws (M2x3) that secure the system board to the palm-rest assembly.
14. Lift the system board off the palm-rest assembly.

Installing the system board

CAUTION: The information in this installation section is intended for authorized service technicians only.

Prerequisites

If you are replacing a component, remove the existing component before performing the installation process.

About this task

The following images indicate the system board connectors.

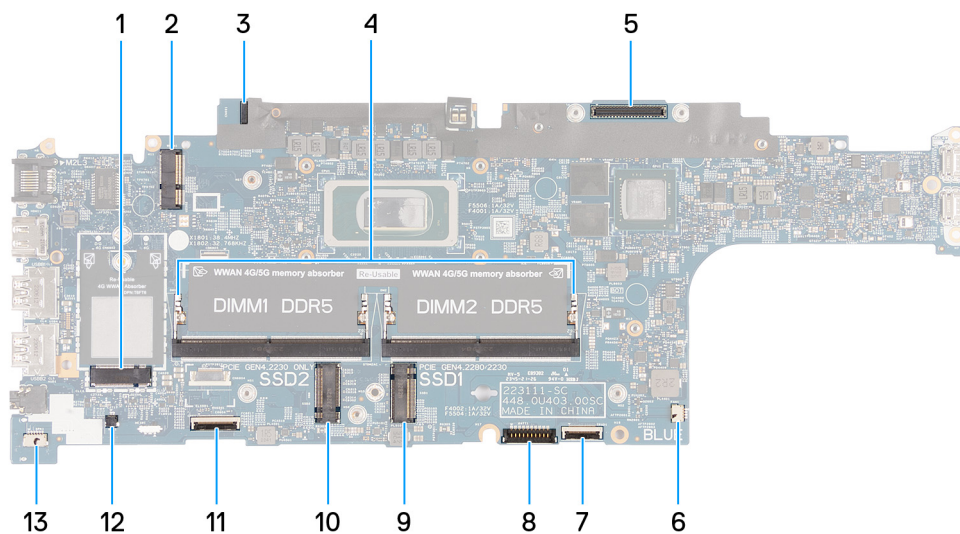

Figure 57. System board connectors

- | | |
|-------------------------------------|--|
| 1. WWAN-card connector (WWAN1) | 2. Wireless-card connector (WLAN1) |
| 3. Sensor board-cable connector | 4. Memory modules (DIMM1 and DIMM2) |
| 5. Display-cable connector (LCD1) | 6. System-fan connector (FAN1) |
| 7. Touchpad-cable connector (TPAD1) | 8. Battery-cable connector (BATT1) |
| 9. Solid-state drive Slot 1 (SSD1) | 10. Solid-state drive Slot 2 (SSD2) |
| 11. USH-cable connector | 12. Coin-cell battery cable connector (RTC1) |
| 13. Speaker-cable connector (SPK1) | |

The following images indicate the location of the system board and provide a visual representation of the installation procedure.

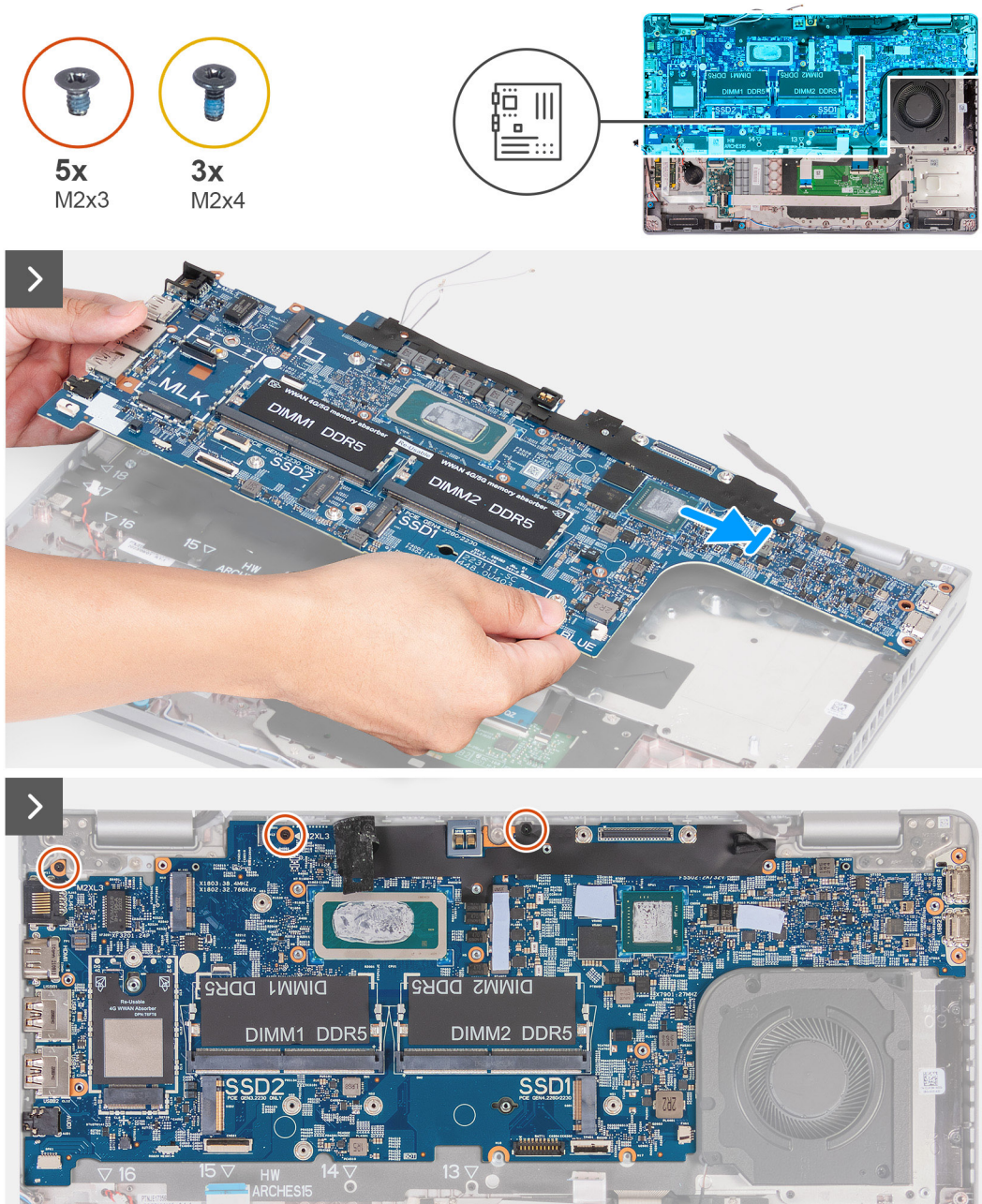

Figure 58. Installing the system board

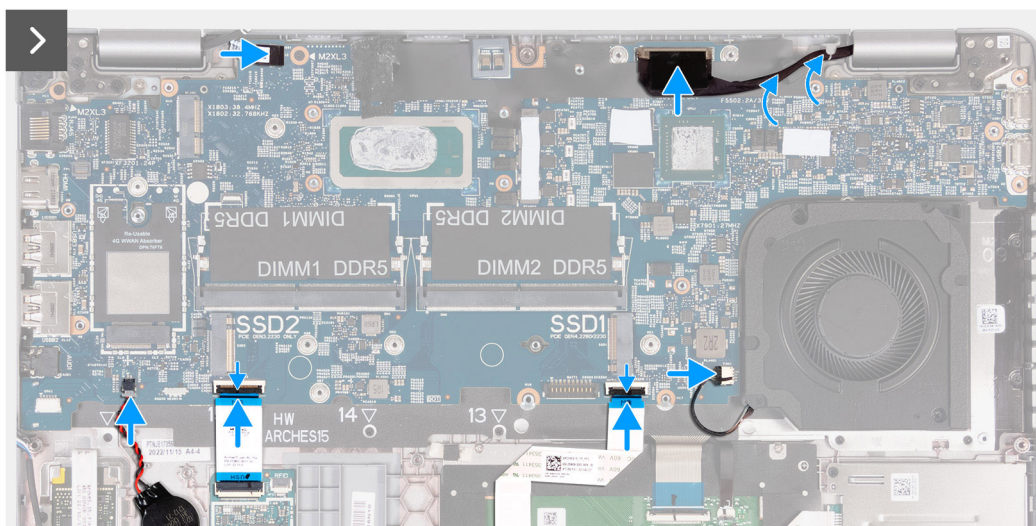

Figure 59. Installing the system board

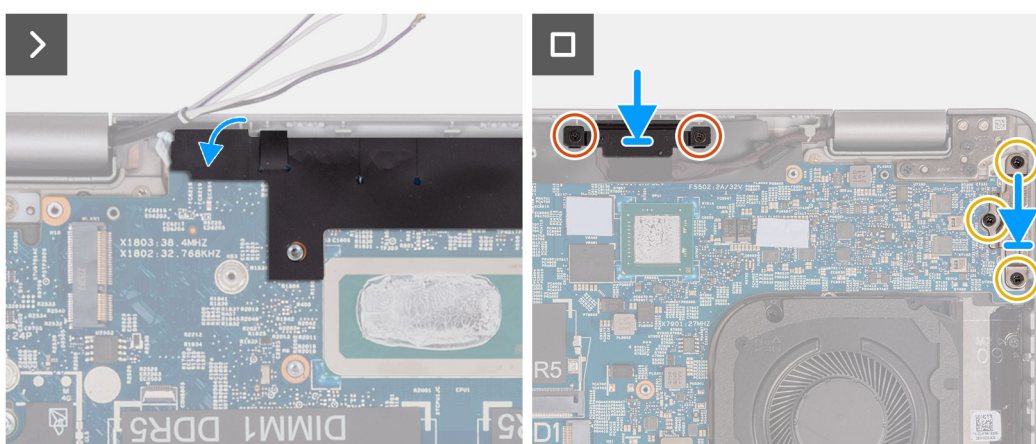

Figure 60. Installing the system board

Steps

1. Align and place the system board on its slot on the palm-rest assembly.
2. Replace the two screws (M2x3) that secure the system board to the palm-rest assembly.
3. Connect the sensor board-cable to the connector on the system board.
4. Connect the display cable to the display cable connector (LCD1) on the system board.
5. Route the display cable through the routing guides on the system board.
6. Connect the touchpad cable to the touchpad cable connector (TPAD1) on the system board and close the latch to secure the cable.
7. Connect the USH cable to the USH module and close the latch to secure the cable.
8. Adhere the coin-cell battery on to the coin-cell battery slot on the palm-rest assembly.
9. Adhere the black flap near the antenna cables and cover the sensor board-cable.
10. Place the display-cable bracket over the display cable.
11. Replace the two screws (M2x3) that secure the display-cable bracket to the palm-rest assembly.
12. Place the Type-C bracket on its slot on the palm-rest assembly.
13. Replace the three screws (M2x4) that secure the Type-C bracket to the palm-rest assembly.

Next steps

1. Install the [assembly-inner frame](#).
2. Install the [battery](#).

3. Install the [heat sink \(discrete GPU\)](#) or [heat sink \(integrated GPU\)](#), as applicable.
4. Install the [M.2 2230 SSD](#) in slot 2, if applicable.
5. Install the [M.2 2230](#) or [M.2 2280 SSD](#) in slot 1, as applicable.
6. Install the [memory modules](#).
7. Install the [wireless card](#).
8. Install the [4G WWAN card](#) or [5G WWAN card](#), as applicable.
9. Install the [base cover](#).
10. Install the [SIM card](#).
11. Follow the procedure in [After working inside your computer](#).

Power button

Removing the power button

 **CAUTION:** The information in this installation section is intended for authorized service technicians only.

Prerequisites

1. Follow the procedure in [Before working inside your computer](#).
2. Remove the [SIM card](#).
3. Remove the [base cover](#).
4. Remove the [4G WWAN card](#) or [5G WWAN card](#), as applicable.
5. Remove the [wireless card](#).
6. Remove the [memory modules](#).
7. Remove the [M.2 2230](#) or [M.2 2280 SSD](#) from slot 1, as applicable.
8. Remove the [M.2 2230 SSD](#) from slot 2, if applicable.
9. Remove the [battery](#).
10. Remove the [assembly-inner frame](#).
11. Remove the [system board](#).

 **NOTE:** The system board can be removed and installed with the heat sink attached in order to simplify the procedure and preserve the thermal bond between the system board and heat sink.

About this task

The following images indicate the location of the power button and provide a visual representation of the removal procedure.

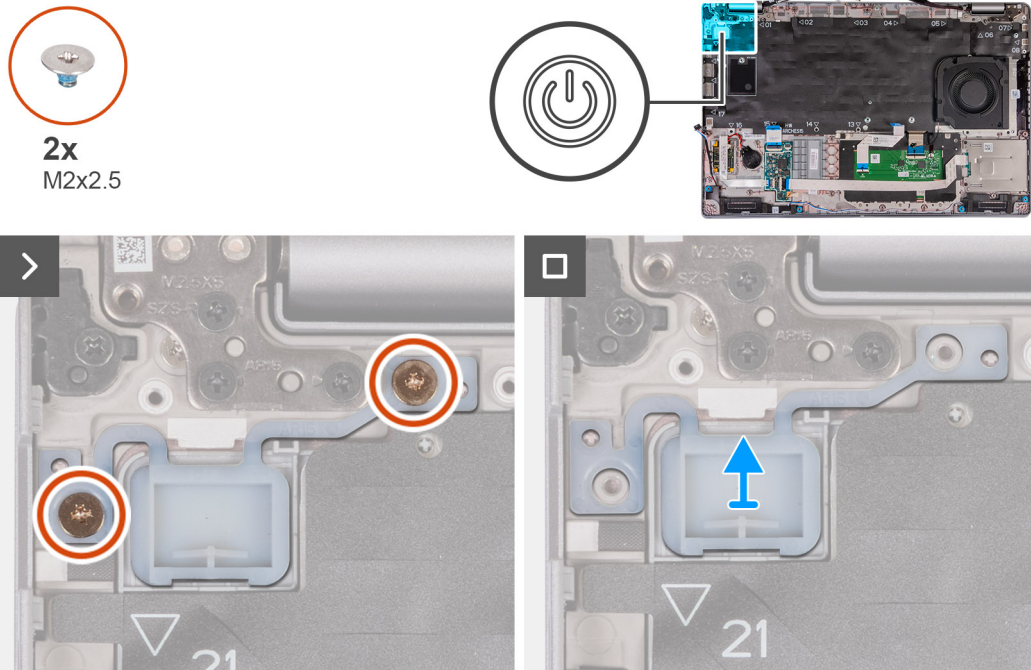

Figure 61. Removing the power button

Steps

1. Remove the two (M2x2.5) screws that secure the power button to the palm-rest assembly.
2. Lift the power button off the palm-rest assembly.

Installing the power button

CAUTION: The information in this installation section is intended for authorized service technicians only.

Prerequisites

If you are replacing a component, remove the existing component before performing the installation process.

About this task

The following images indicate the location of the power button and provide a visual representation of the installation procedure.

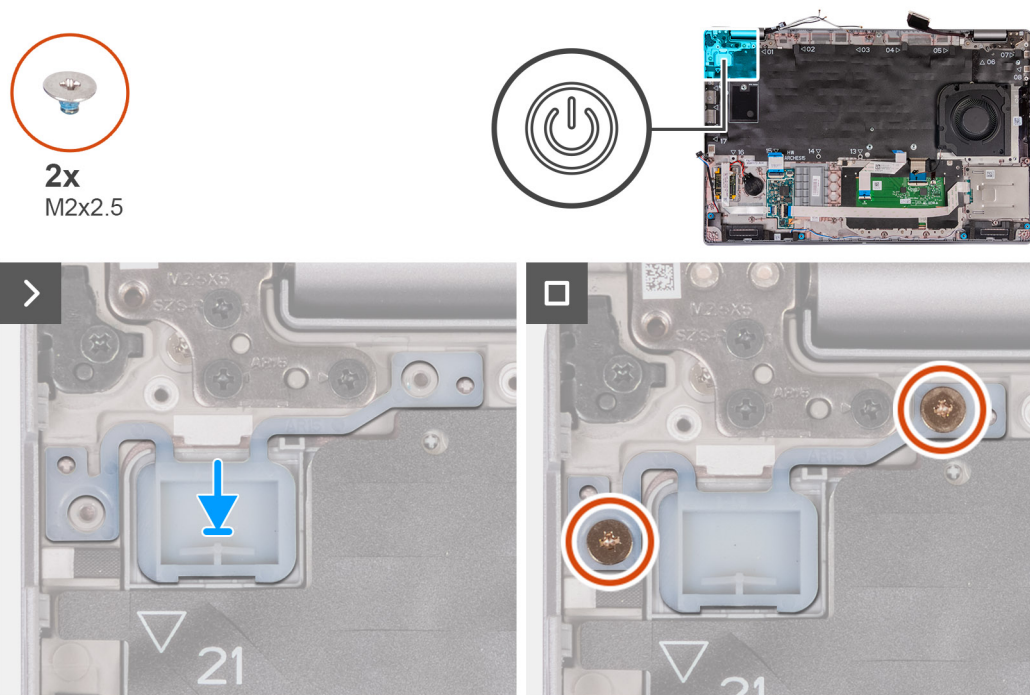

Figure 62. Installing the power button

Steps

1. Align and place the power button on the palm-rest assembly.
2. Replace the two (M2x2.5) screws to secure the power button to the palm-rest assembly.

Next steps

1. Install the [system board](#).

NOTE: The system board can be removed and installed with the heat sink attached in order to simplify the procedure and preserve the thermal bond between the system board and heat sink.

2. Install the [assembly-inner frame](#).
3. Install the [battery](#).
4. Install the [M.2 2230 SSD](#) in slot 2, if applicable.
5. Install the [M.2 2230](#) or [M.2 2280 SSD](#) in slot 1, as applicable.
6. Install the [memory modules](#).
7. Install the [wireless card](#).
8. Install the [4G WWAN card](#) or [5G WWAN card](#), as applicable.
9. Install the [base cover](#).
10. Install the [SIM card](#).
11. Follow the procedure in [After working inside your computer](#).

Power button with optional fingerprint reader

Removing the power button with an optional fingerprint reader

CAUTION: The information in this removal section is intended for authorized service technicians only.

Prerequisites

1. Follow the procedure in [Before working inside your computer](#).

2. Remove the [SIM card](#).
3. Remove the [base cover](#).
4. Remove the [4G WWAN card](#) or [5G WWAN card](#), as applicable.
5. Remove the [wireless card](#).
6. Remove the [memory modules](#).
7. Remove the [M.2 2230](#) or [M.2 2280](#) SSD from slot 1, as applicable.
8. Remove the [M.2 2230](#) SSD from slot 2, if applicable.
9. Remove the [battery](#).
10. Remove the [assembly-inner frame](#).
11. Remove the [system board](#).

NOTE: The system board can be removed and installed with the heat sink attached in order to simplify the procedure and preserve the thermal bond between the system board and heat sink.

About this task

The following images indicate the location of the power button with an optional fingerprint reader and provide a visual representation of the removal procedure.

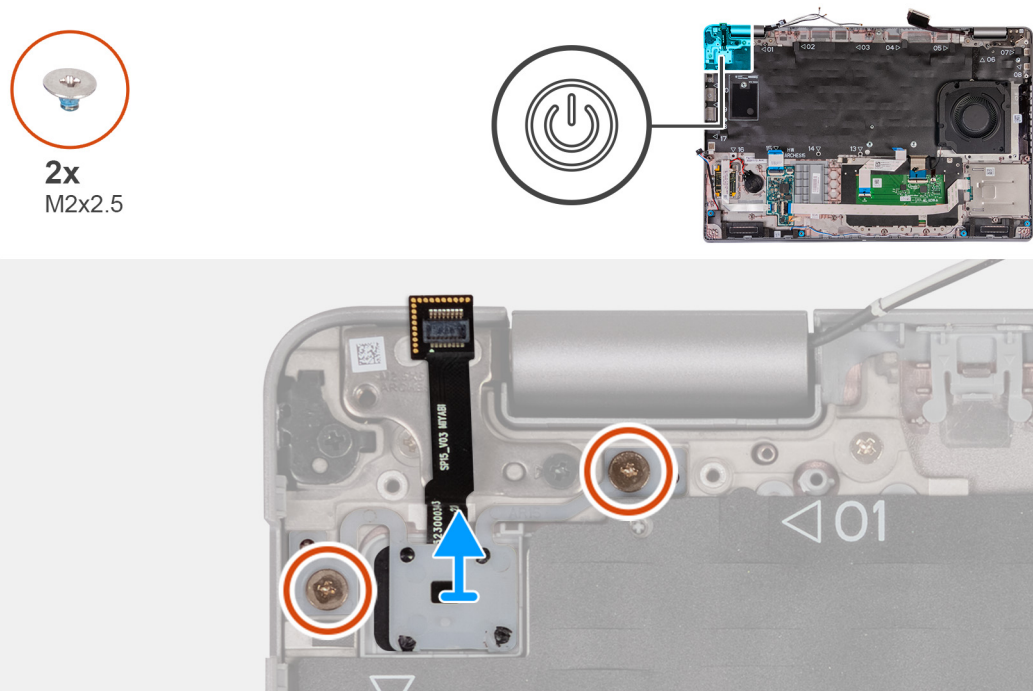

Figure 63. Removing the power button with an optional fingerprint reader

Steps

1. Remove the two (M2x2.5) screws that secure the power button to the palm-rest assembly.
2. Lift the power button off the palm-rest assembly.

Installing the power button with an optional fingerprint reader

CAUTION: The information in this installation section is intended for authorized service technicians only.

Prerequisites

If you are replacing a component, remove the existing component before performing the installation process.

About this task

The following images indicate the location of the power button with an optional fingerprint reader and provide a visual representation of the installation procedure.

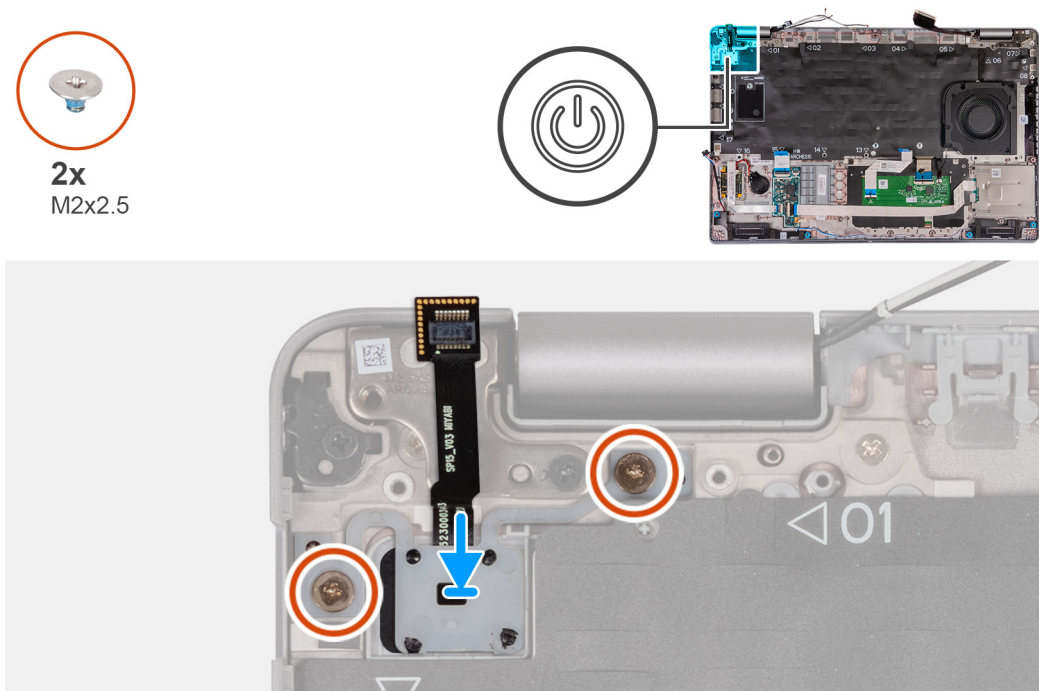

Figure 64. Installing the power button with an optional fingerprint reader

Steps

1. Align and place the power button on the palm-rest assembly.
2. Replace the two (M2x2.5) screws to secure the power button to the palm-rest assembly.

Next steps

1. Install the [system board](#).

NOTE: The system board can be removed and installed with the heat sink attached in order to simplify the procedure and preserve the thermal bond between the system board and heat sink.

2. Install the [assembly-inner frame](#).
3. Install the [battery](#).
4. Install the [M.2 2230](#) SSD in slot 2, if applicable.
5. Install the [M.2 2230](#) or [M.2 2280](#) SSD in slot 1, as applicable.
6. Install the [memory modules](#).
7. Install the [wireless card](#).
8. Install the [4G WWAN card](#) or [5G WWAN card](#), as applicable.
9. Install the [base cover](#).
10. Install the [SIM card](#).
11. Follow the procedure in [After working inside your computer](#).

Keyboard

Removing the keyboard

CAUTION: The information in this removal section is intended for authorized service technicians only.

Prerequisites

1. Follow the procedure in [Before working inside your computer](#).
2. Remove the [SIM card](#).
3. Remove the [base cover](#).
4. Remove the [4G WWAN card](#) or [5G WWAN card](#), as applicable.
5. Remove the [wireless card](#).
6. Remove the [memory modules](#).
7. Remove the [M.2 2230](#) or [M.2 2280 SSD](#) from slot 1, as applicable.
8. Remove the [M.2 2230 SSD](#) from slot 2, if applicable.
9. Remove the [battery](#).
10. Remove the [assembly-inner frame](#).
11. Remove the [system board](#).

NOTE: The system board can be removed and installed with the heat sink attached in order to simplify the procedure and preserve the thermal bond between the system board and heat sink.

About this task

The following images indicate the location of the keyboard and provide a visual representation of the removal procedure.

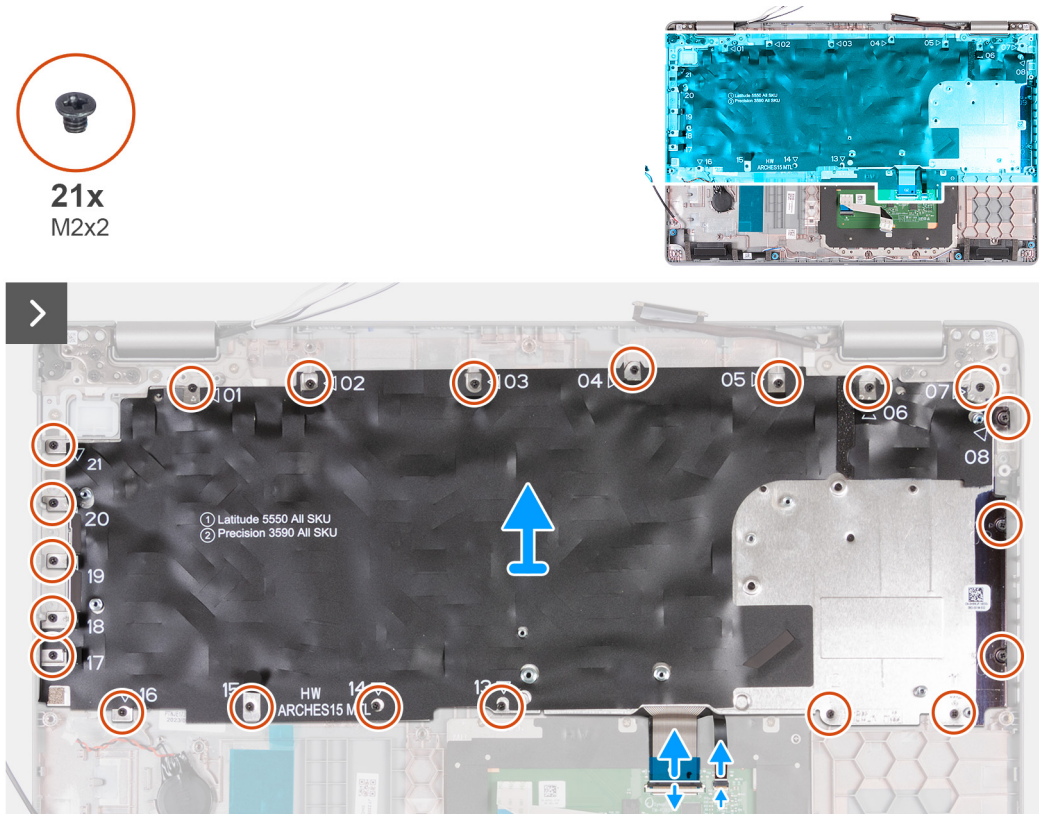

Figure 65. Removing the keyboard



10x
M2x2



Figure 66. Removing the keyboard

Steps

1. Open the latch and disconnect the keyboard cable from the touchpad.
i **NOTE:** For the keyboard the latch is the "black" portion of the connector.
2. Open the latch and disconnect the keyboard-backlight cable from the touchpad.
i **NOTE:** For the keyboard-backlight the latch is the "white" portion of the connector.
3. Remove the twenty-one screws (M2x2) that secure the keyboard bracket to the palm-rest assembly.
4. Lift the keyboard bracket off the palm-rest assembly.
5. Turn the keyboard bracket over.
6. Remove the ten screws (M2x2) that secure the keyboard to the keyboard bracket.
7. Lift the keyboard off the keyboard bracket.

Installing the keyboard

CAUTION: The information in this installation section is intended for authorized service technicians only.

Prerequisites

If you are replacing a component, remove the existing component before performing the installation process.

About this task

The following images indicate the location of the keyboard and provide a visual representation of the installation procedure.



10x
M2x2



Figure 67. Installing the keyboard



21x
M2x2

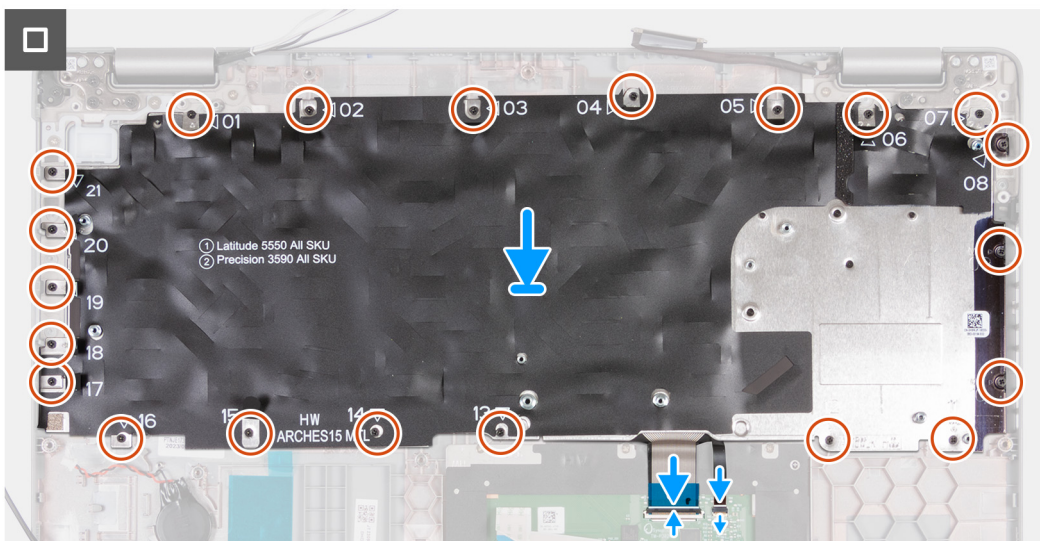
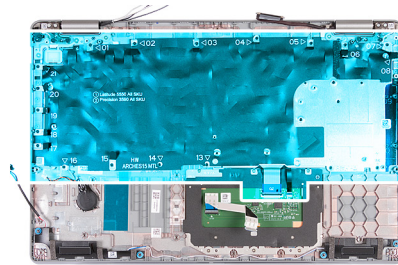



Figure 68. Installing the keyboard

Steps

1. Align and place the keyboard on the keyboard bracket.
2. Replace the ten screws (M2x2) to secure the keyboard to the keyboard bracket.
3. Turn the keyboard bracket over.
4. Align and place the keyboard bracket on the palm-rest assembly.
5. Replace the twenty-one screws (M2x2) that secure the keyboard bracket to the palm-rest assembly.
6. Connect the keyboard-backlight cable to the connector on the touchpad and close the latch to secure the cable.

 **NOTE:** For the keyboard-backlight the latch is the "white" portion of the connector.

7. Connect the keyboard cable to the connector on the touchpad and close the latch to secure the cable.

 **NOTE:** For the keyboard the latch is the "black" portion of the connector.

Next steps

1. Install the [system board](#).

 **NOTE:** The system board can be removed and installed with the heat sink attached in order to simplify the procedure and preserve the thermal bond between the system board and heat sink.

2. Install the [assembly-inner frame](#).
3. Install the [battery](#).
4. Install the [M.2 2230](#) SSD in slot 2, if applicable.
5. Install the [M.2 2230](#) or [M.2 2280](#) SSD in slot 1, as applicable.
6. Install the [memory modules](#).
7. Install the [wireless card](#).
8. Install the [4G WWAN card](#) or [5G WWAN card](#), as applicable.
9. Install the [base cover](#).
10. Install the [SIM card](#).
11. Follow the procedure in [After working inside your computer](#).

Display assembly

Removing the display assembly

 **CAUTION:** The information in this removing section is intended for authorized service technicians only.

Prerequisites

1. Follow the procedure in [Before working inside your computer](#).
2. Remove the [SIM card](#).
3. Remove the [base cover](#).
4. Remove the [4G WWAN card](#) or [5G WWAN card](#), as applicable.
5. Remove the [wireless card](#).

About this task

The following images indicate the location of the display assembly and provide a visual representation of the removal procedure.

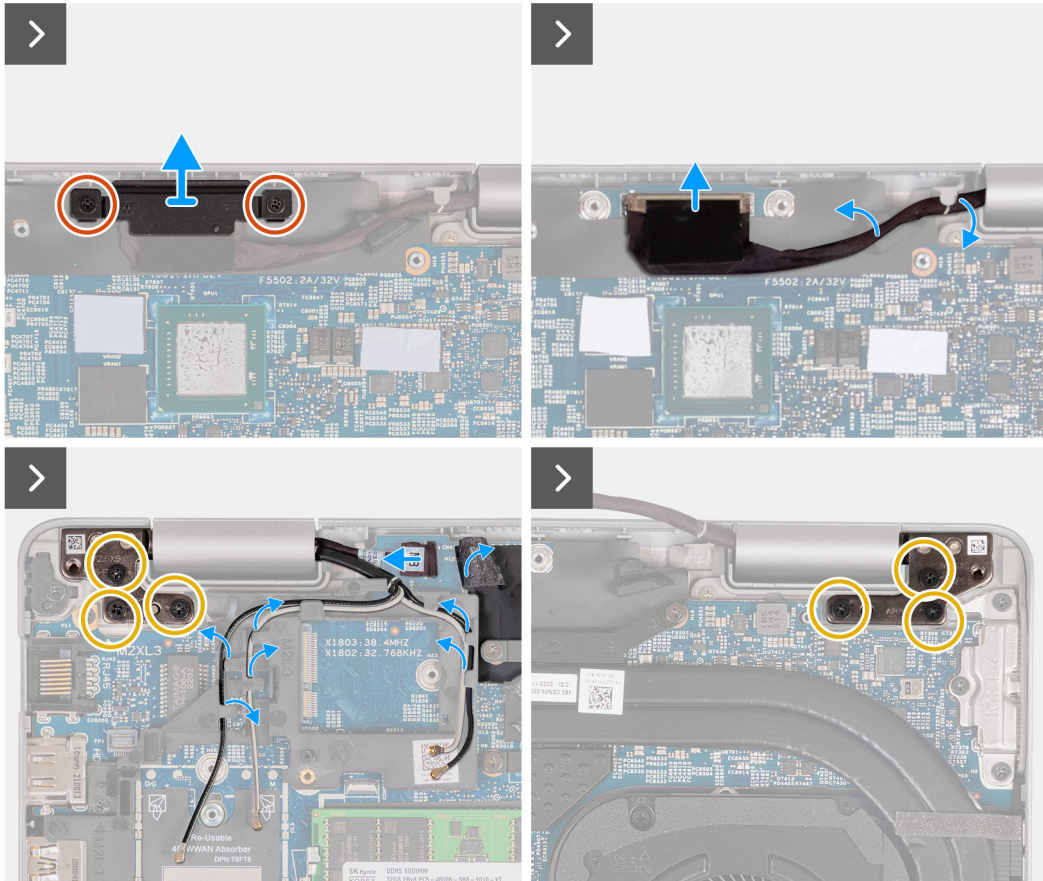
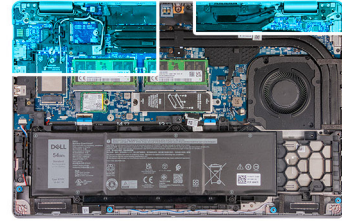

Figure 69. Removing the display assembly

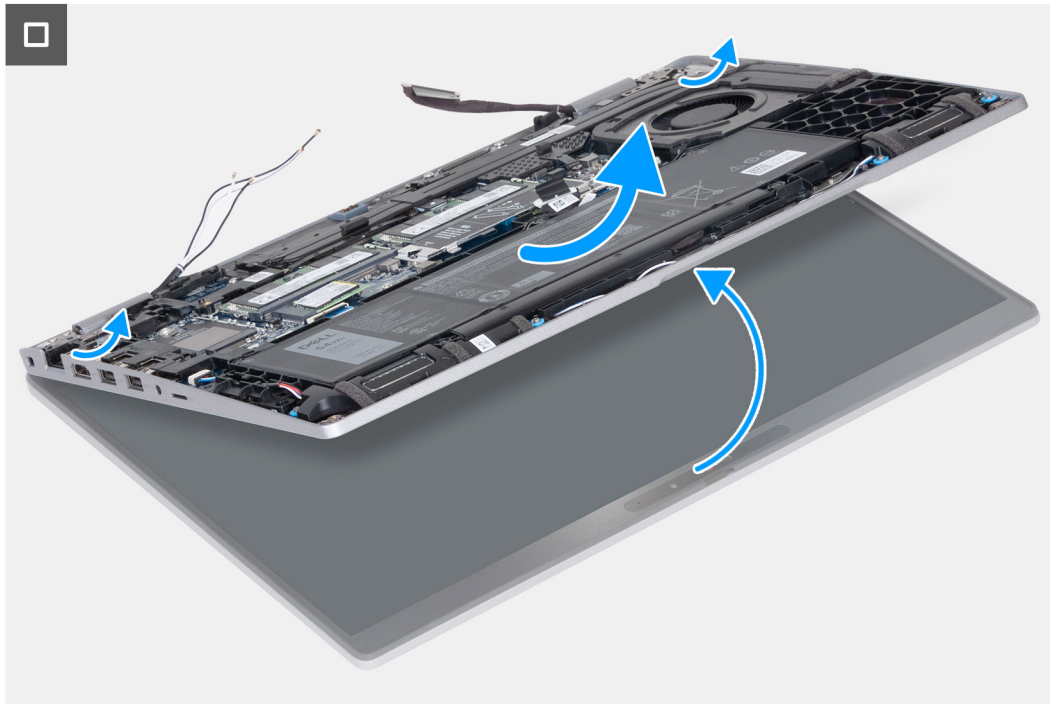

Figure 70. Removing the display assembly

Steps

1. Remove the two (M2x3) screws that secure the display-cable bracket to the system board.
2. Lift the display-cable bracket off the palm-rest assembly.
3. Disconnect the display cable from the display cable connector (LCD1) on the system board.
4. Remove the display cable from the routing guides on the system board.
5. Lift the black flap near the antenna cables to uncover the sensor-board cable.
6. Disconnect the sensor-board cable from the connector on the system board.
7. Remove the antenna cables (where applicable) from the routing guides on the system board.
8. Remove the six screws (M2.5x5) that secure the left and right display hinges to the palm-rest assembly.
9. Carefully lift the display assembly from the palm-rest assembly.
10. Carefully place the display assembly on a clean, flat surface.



Figure 71. Display assembly

Installing the display assembly

CAUTION: The information in this installation section is intended for authorized service technicians only.

Prerequisites

If you are replacing a component, remove the existing component before performing the installation process.

About this task

The following images indicate the location of the display assembly and provide a visual representation of the installation procedure.

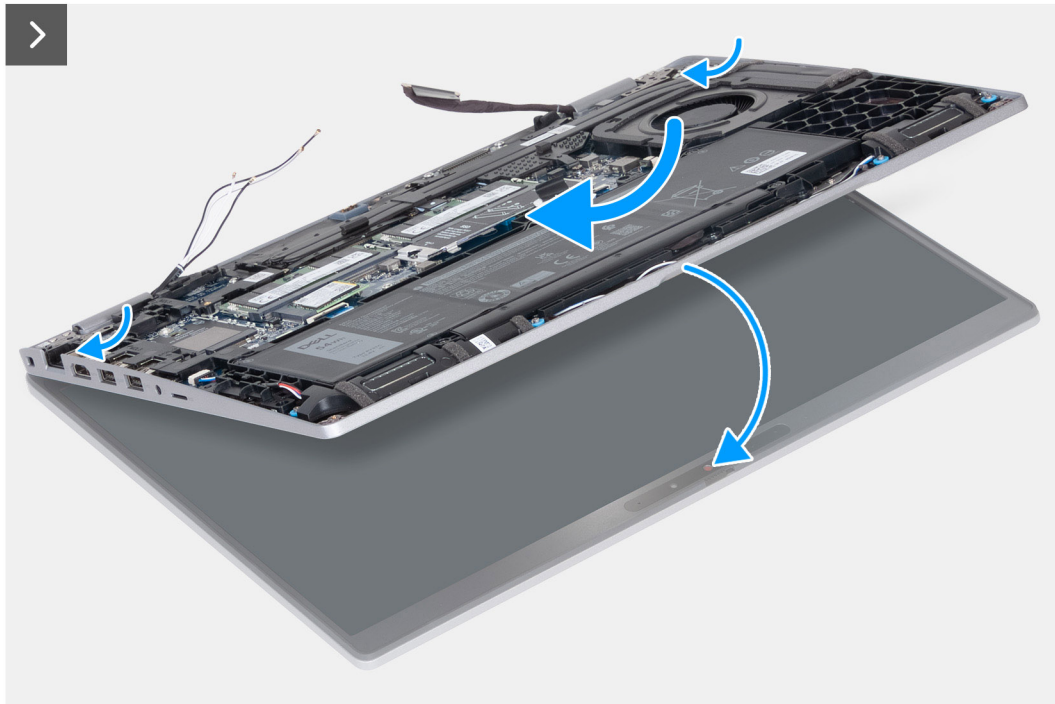

Figure 72. Installing the display assembly

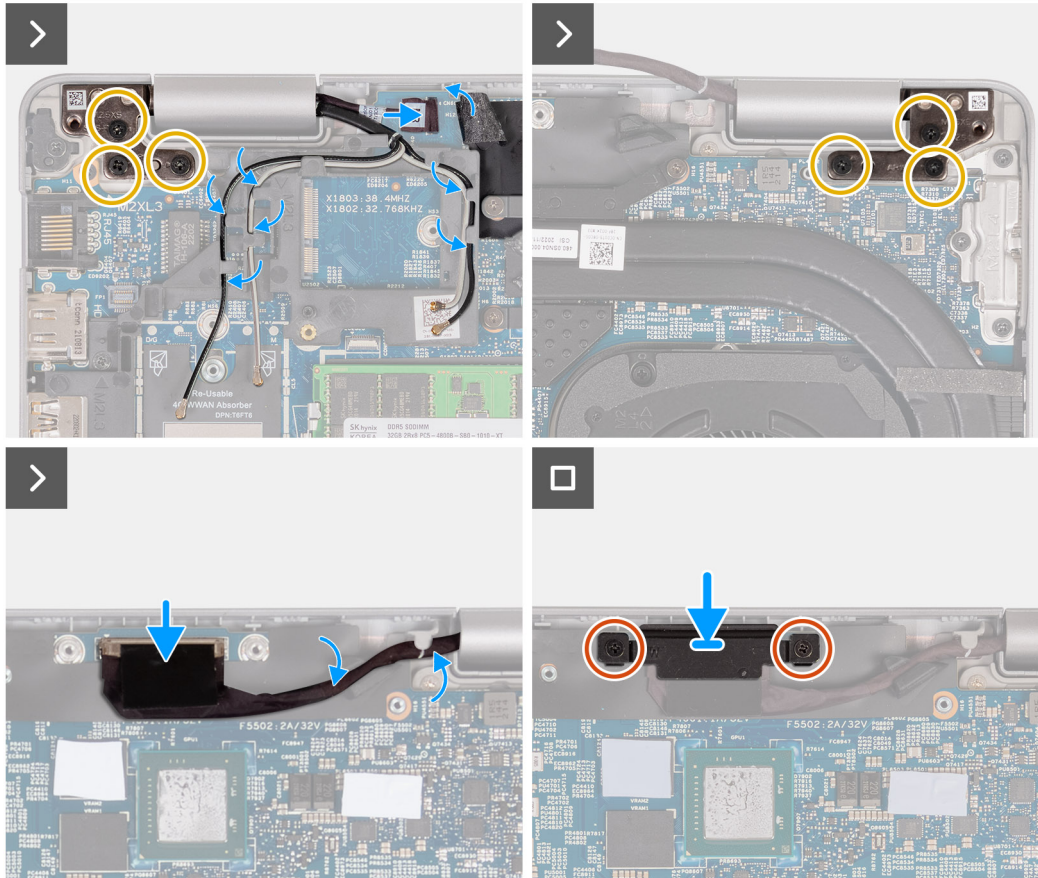
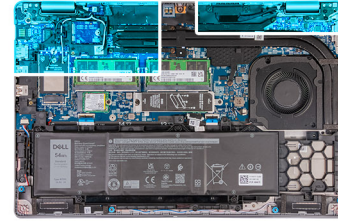

Figure 73. Installing the display assembly

Steps

1. Place the palm-rest assembly at the edge of the table with the speakers facing away from the edge.
2. Align the screw holes on the palm-rest assembly with the screw holes on the display hinges.
3. Replace the six screws (M2.5x5) that secure the left and right display hinges to the palm-rest assembly.
4. Connect the sensor-board cable to the connector on the system board.
5. Cover the sensor-board cable with the black flap near the antenna cables.
6. Route the antenna cables (where applicable) from the routing guides on the system board.
7. Connect the display cable to the display cable connector (LCD1) on the system board.
8. Adhere the tape that secures the display cable to the system board.
9. Align the screw holes on the display-cable bracket with the screw holes on the system board.
10. Replace the two (M2x3) screws that secure the display cable bracket to the system board.

Next steps

1. Install the [wireless card](#).
2. Install the [4G WWAN card](#) or [5G WWAN card](#), as applicable.
3. Install the [base cover](#).
4. Install the [SIM card](#).

5. Follow the procedure in [After working inside your computer](#).

Display bezel

Removing the display bezel

CAUTION: The information in this removal section is intended for authorized service technicians only.

Prerequisites

1. Follow the procedure in [Before working inside your computer](#).
2. Remove the [SIM card](#).
3. Remove the [base cover](#).
4. Remove the [4G WWAN card](#) or [5G WWAN card](#), as applicable.
5. Remove the [wireless card](#).
6. Remove the [display assembly](#).

About this task

The following images indicate the location of the display bezel and provide a visual representation of the removal procedure.

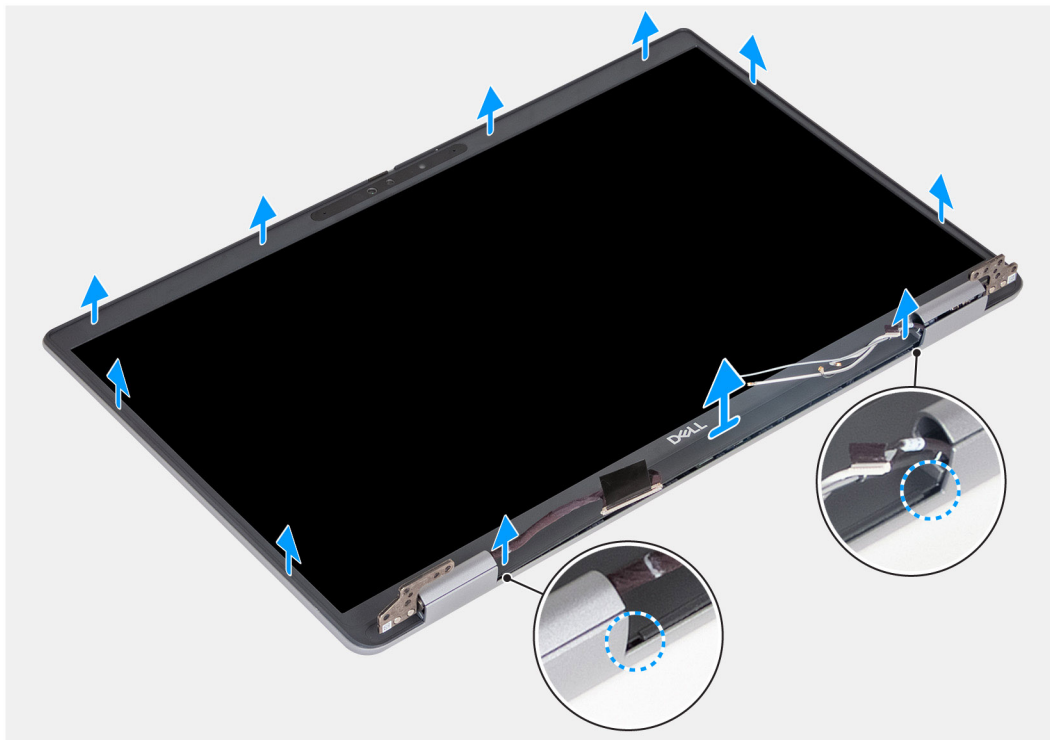

Figure 74. Removing the display bezel

Steps

1. Carefully pry up the display bezel starting from the recesses on the bottom edge of the display near the left and right hinges.
2. Pry along the outside edge of the display bezel and work your way around the entire display bezel, until the display bezel is separated from the display cover.
3. Lift the display bezel from the display assembly.

Installing the display bezel

CAUTION: The information in this installation section is intended for authorized service technicians only.

Prerequisites

If you are replacing a component, remove the existing component before performing the installation process.

About this task

The following images indicate the location of the display bezel and provide a visual representation of the installation procedure.

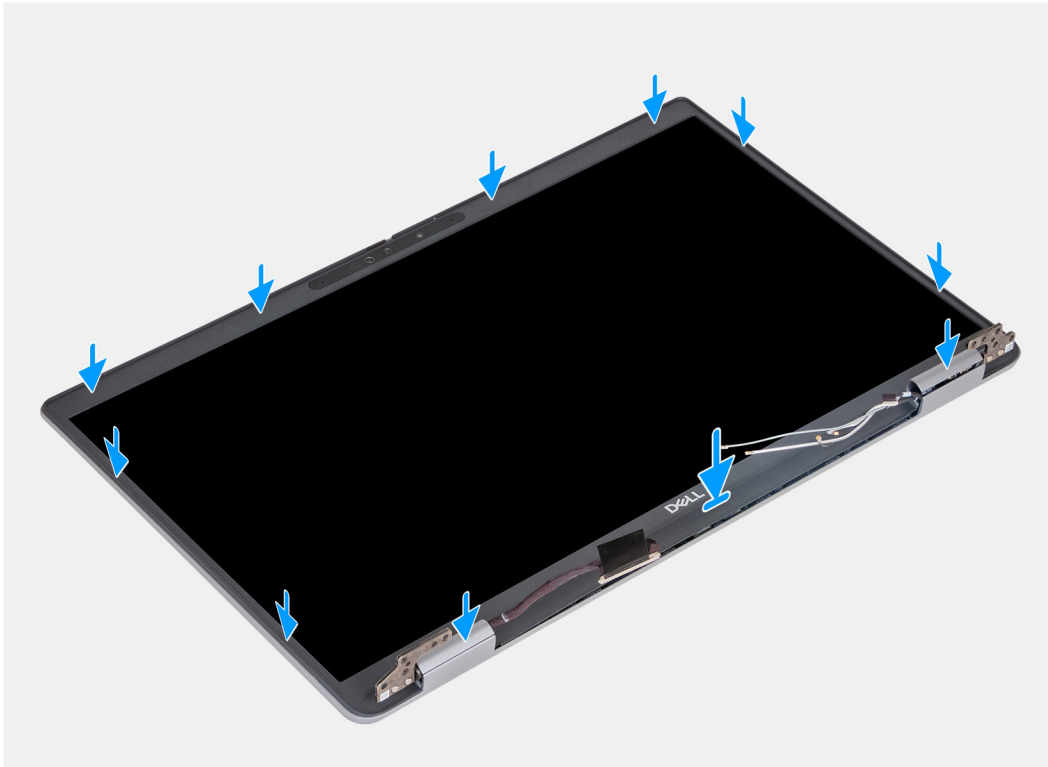

Figure 75. Installing the display bezel

Steps

1. Align and place the display bezel on the display assembly.
2. Gently snap the display bezel into place.

Next steps

1. Install the [display assembly](#).
2. Install the [wireless card](#).
3. Install the [4G WWAN card](#) or [5G WWAN card](#), as applicable.
4. Install the [base cover](#).
5. Install the [SIM card](#).
6. Follow the procedure in [After working inside your computer](#).

Display panel

Removing the display panel

CAUTION: The information in this removal section is intended for authorized service technicians only.

Prerequisites

1. Follow the procedure in [Before working inside your computer](#).
2. Remove the [SIM card](#).
3. Remove the [base cover](#).
4. Remove the [4G WWAN card](#) or [5G WWAN card](#), as applicable.
5. Remove the [wireless card](#).
6. Remove the [display assembly](#).
7. Remove the [display bezel](#).

About this task

The following images indicate the location of the display panel and provide a visual representation of the removal procedure.

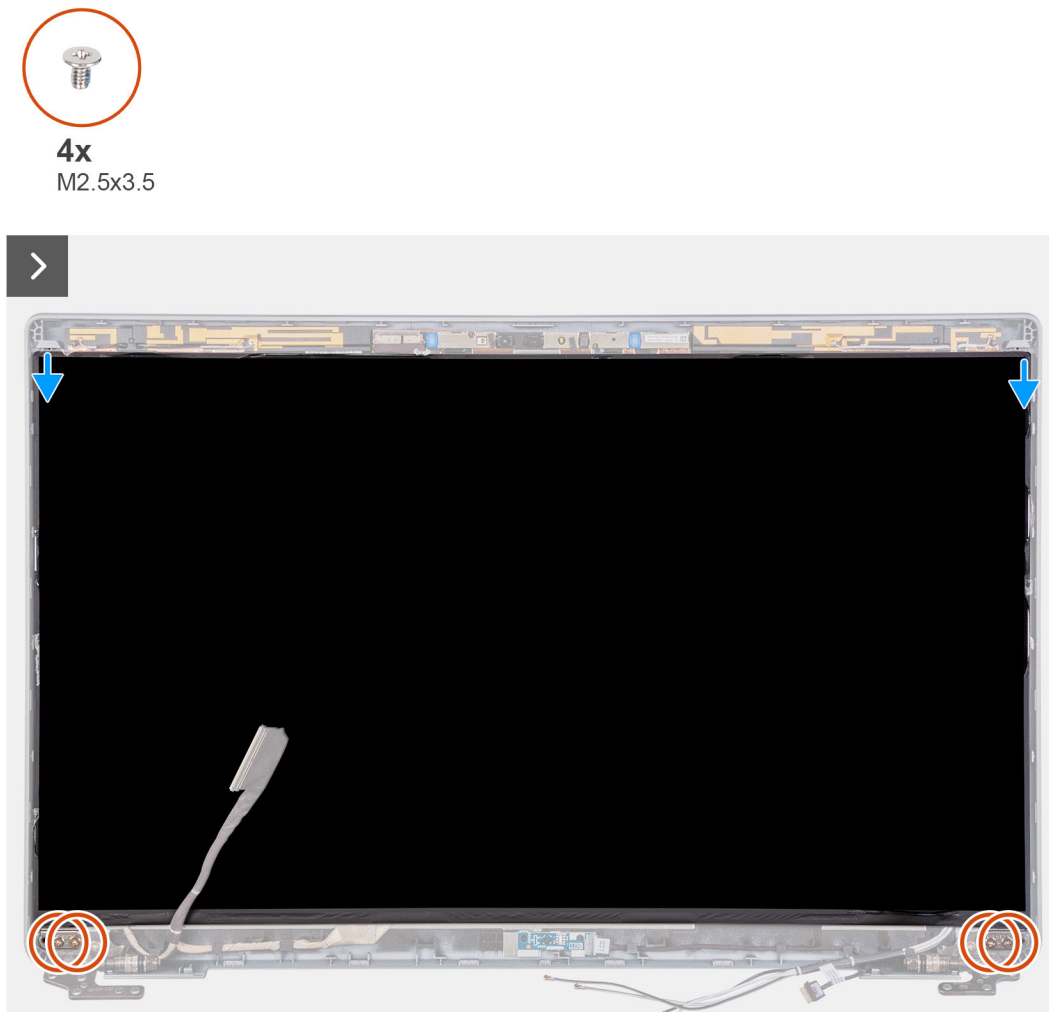

Figure 76. Removing the display panel

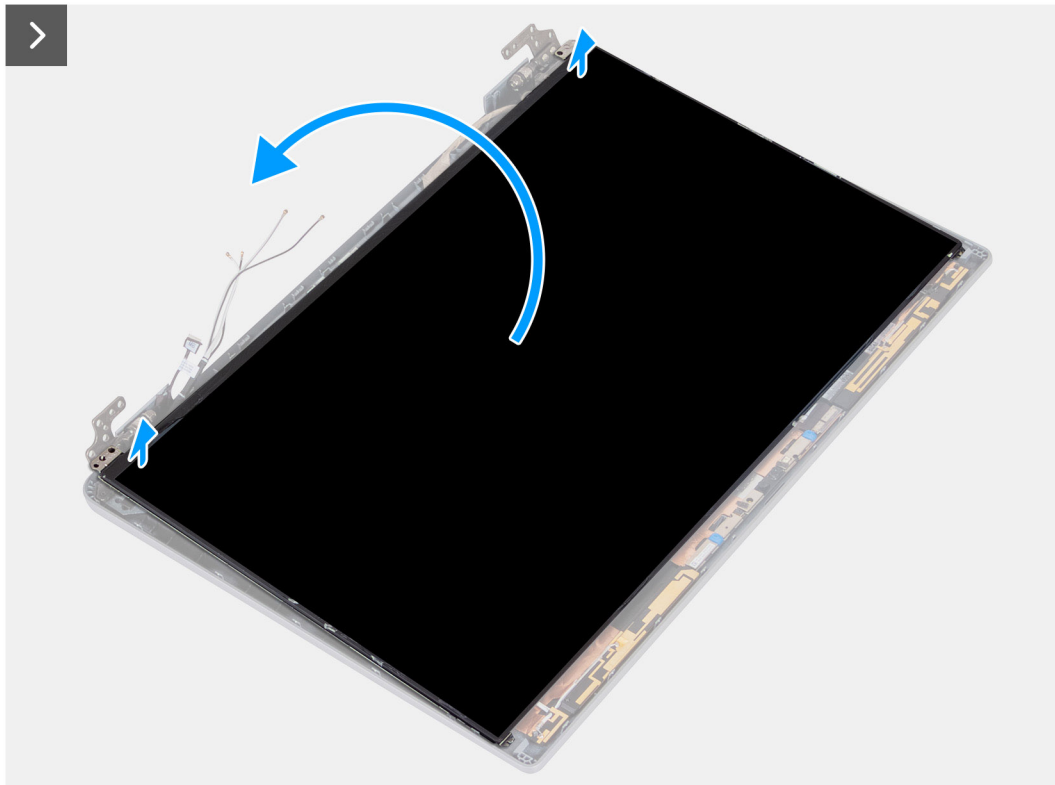

Figure 77. Removing the display panel

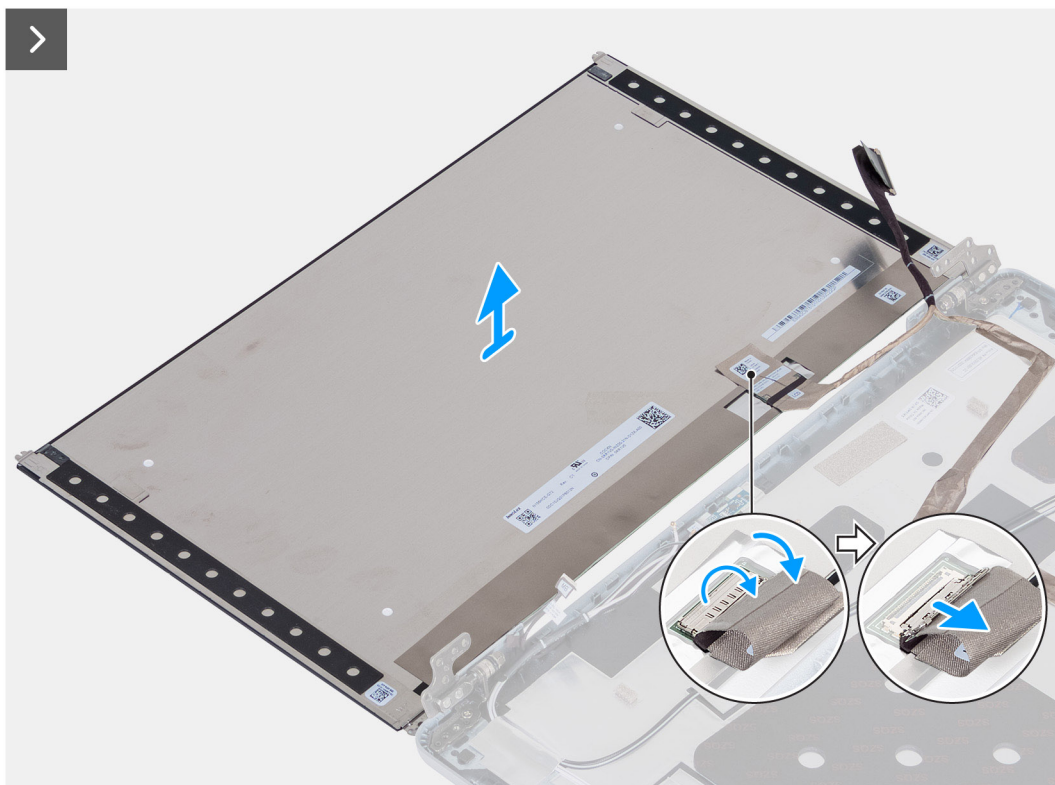

Figure 78. Removing the display panel

Steps

1. Remove the four screws (M2.5x3.5) that secure the display panel to the display back cover.
2. Lift and open the display panel to access the display cable.

3. Peel the conductive tape on the display cable connector.
 4. Open the latch and disconnect the cable from the connector on the display panel.
 5. Lift the display panel away from the display back cover.
- NOTE:** Do not pull and release the Stretch Release (SR) tapes from the display panel. Separation of the brackets from the display panel is not required.

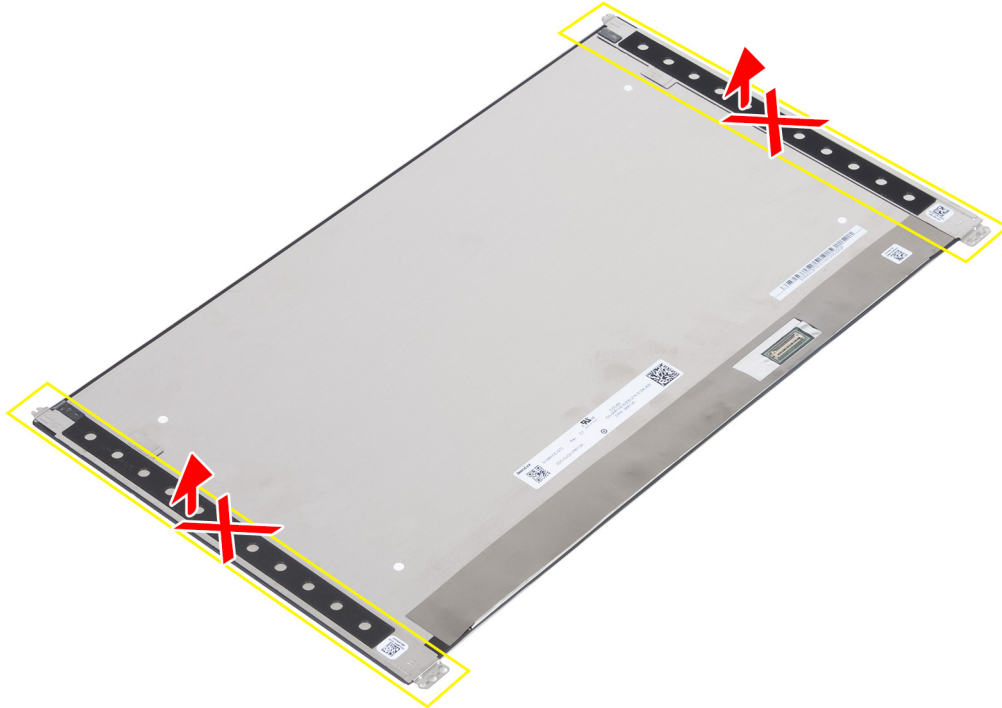

Figure 79. Do not pull and release the Stretch Release (SR) tapes



Figure 80. Display panel

Installing the display panel

CAUTION: The information in this installation section is intended for authorized service technicians only.

Prerequisites

If you are replacing a component, remove the existing component before performing the installation process.

About this task

The following images indicate the location of the display panel and provide a visual representation of the installation procedure.

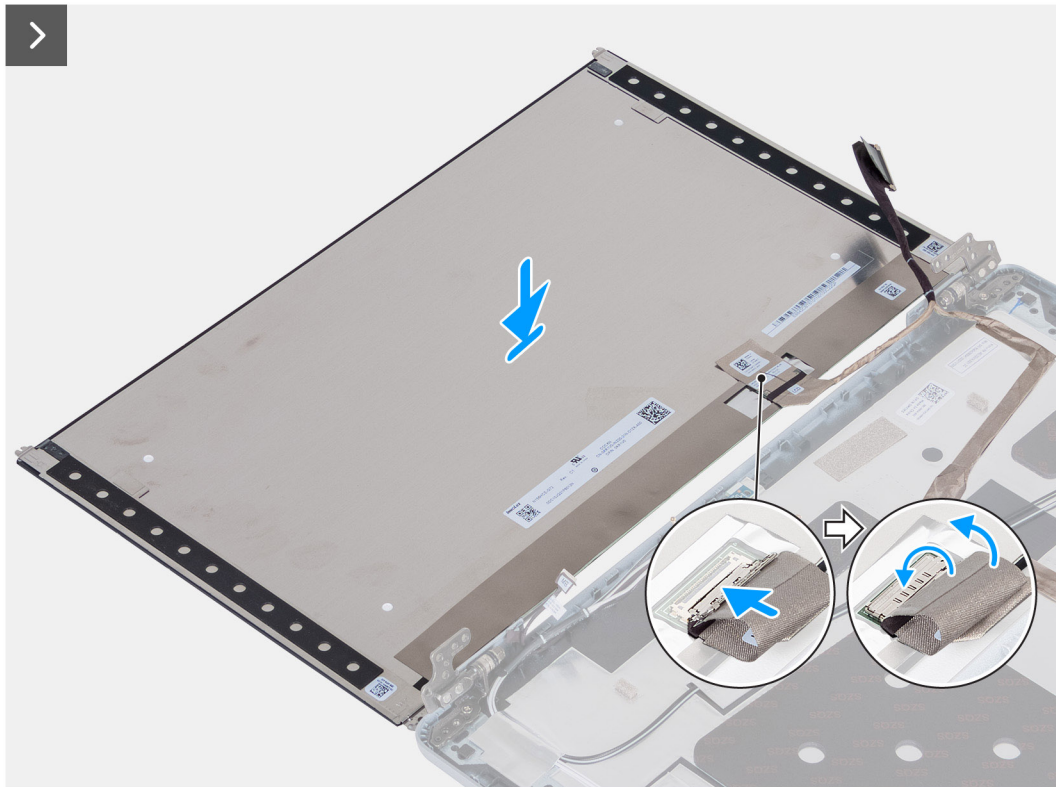

Figure 81. Installing the display panel

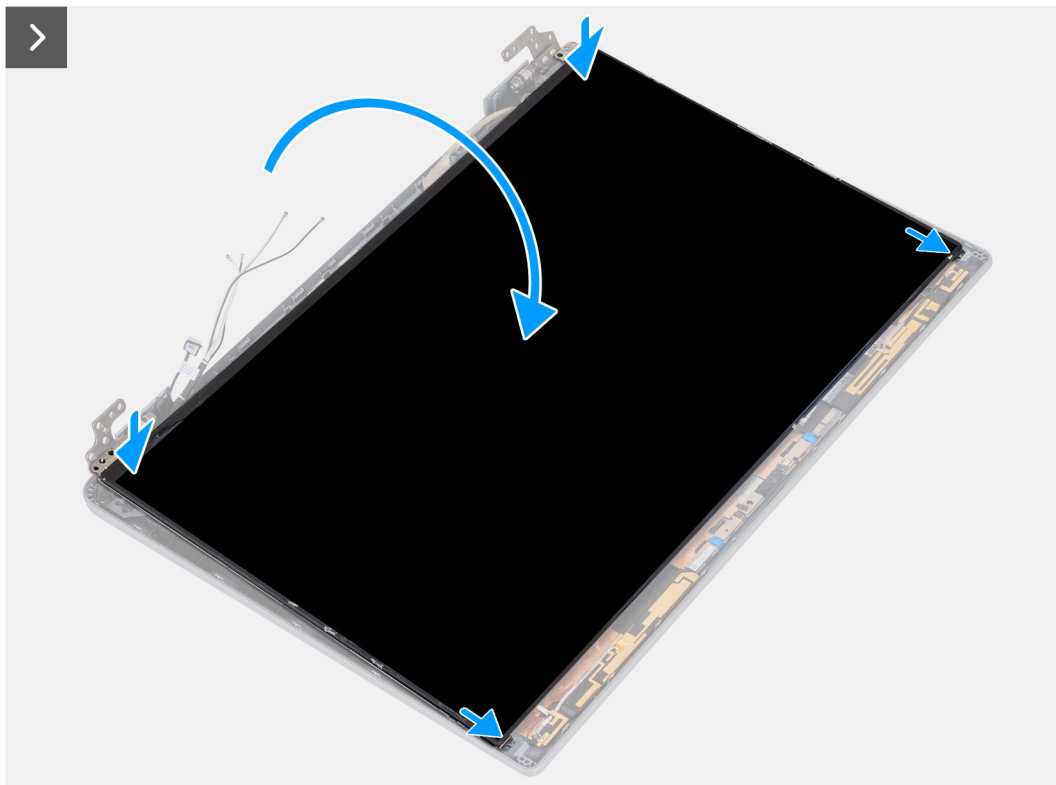

Figure 82. Installing the display panel

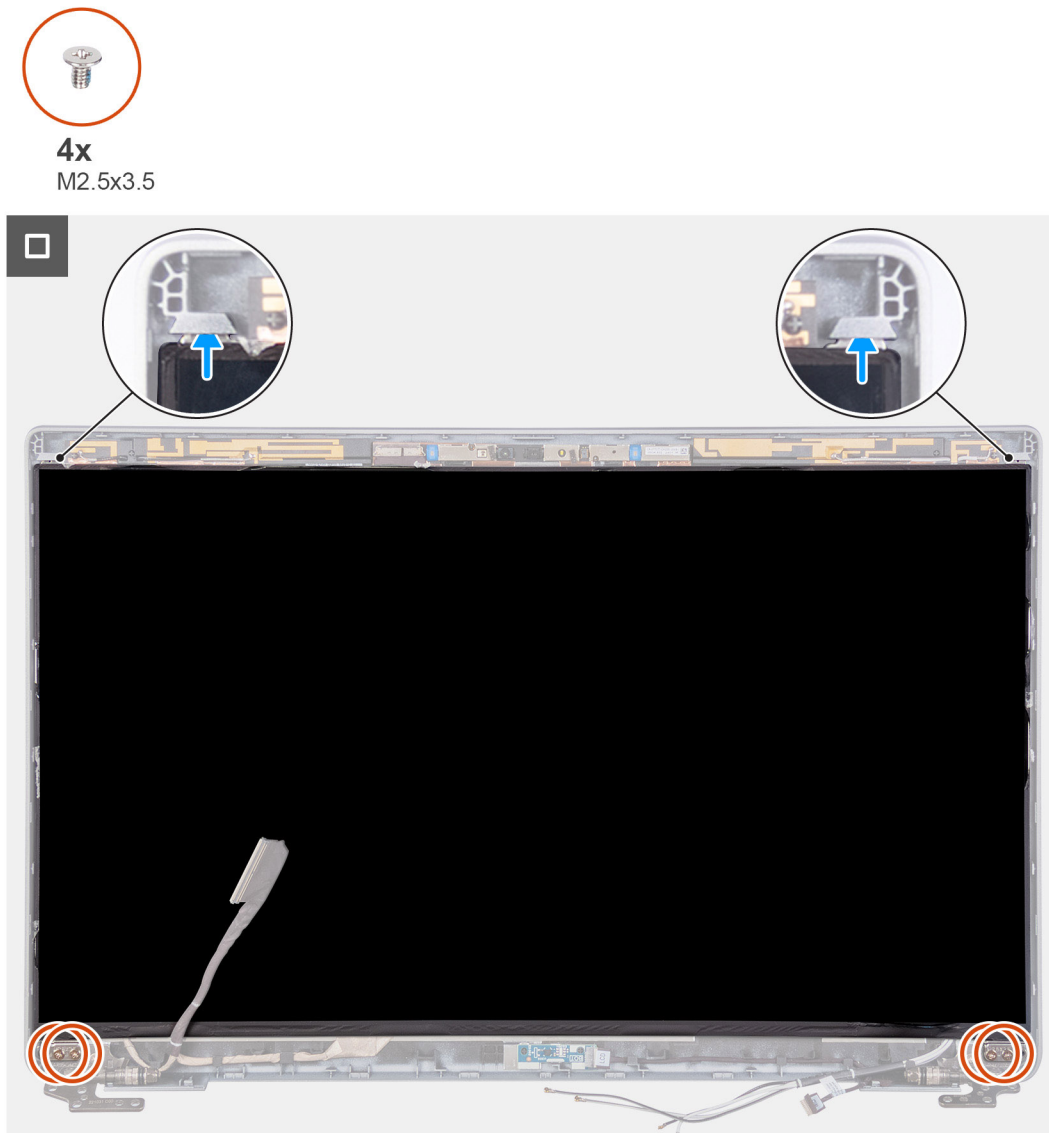

Figure 83. Installing the display panel

Steps

1. Connect the display cable to the connector on the display panel and close the latch.
2. Adhere the conductive tape to secure the display cable to the display panel.
3. Close the display panel and the display back cover to assemble.

i **NOTE:** Ensure that the display panel tabs are inserted into the slots on the display cover.

4. Replace the four screws (M2.5x3.5) to secure the display panel to the display back cover.

Next steps

1. Install the [display bezel](#).
2. Install the [display assembly](#).
3. Install the [wireless card](#).
4. Install the [4G WWAN card](#) or [5G WWAN card](#), as applicable.
5. Install the [base cover](#).
6. Install the [SIM card](#).
7. Follow the procedure in [After working inside your computer](#).

Camera module

Removing the camera module

 **CAUTION:** The information in this removal section is intended for authorized service technicians only.

Prerequisites

1. Follow the procedure in [Before working inside your computer](#).
2. Remove the [SIM card](#).
3. Remove the [base cover](#).
4. Remove the [4G WWAN card](#) or [5G WWAN card](#), as applicable.
5. Remove the [wireless card](#).
6. Remove the [display assembly](#).
7. Remove the [display bezel](#).
8. Remove the [display panel](#).

About this task

The following images indicate the location of the camera module and provide a visual representation of the removal procedure.

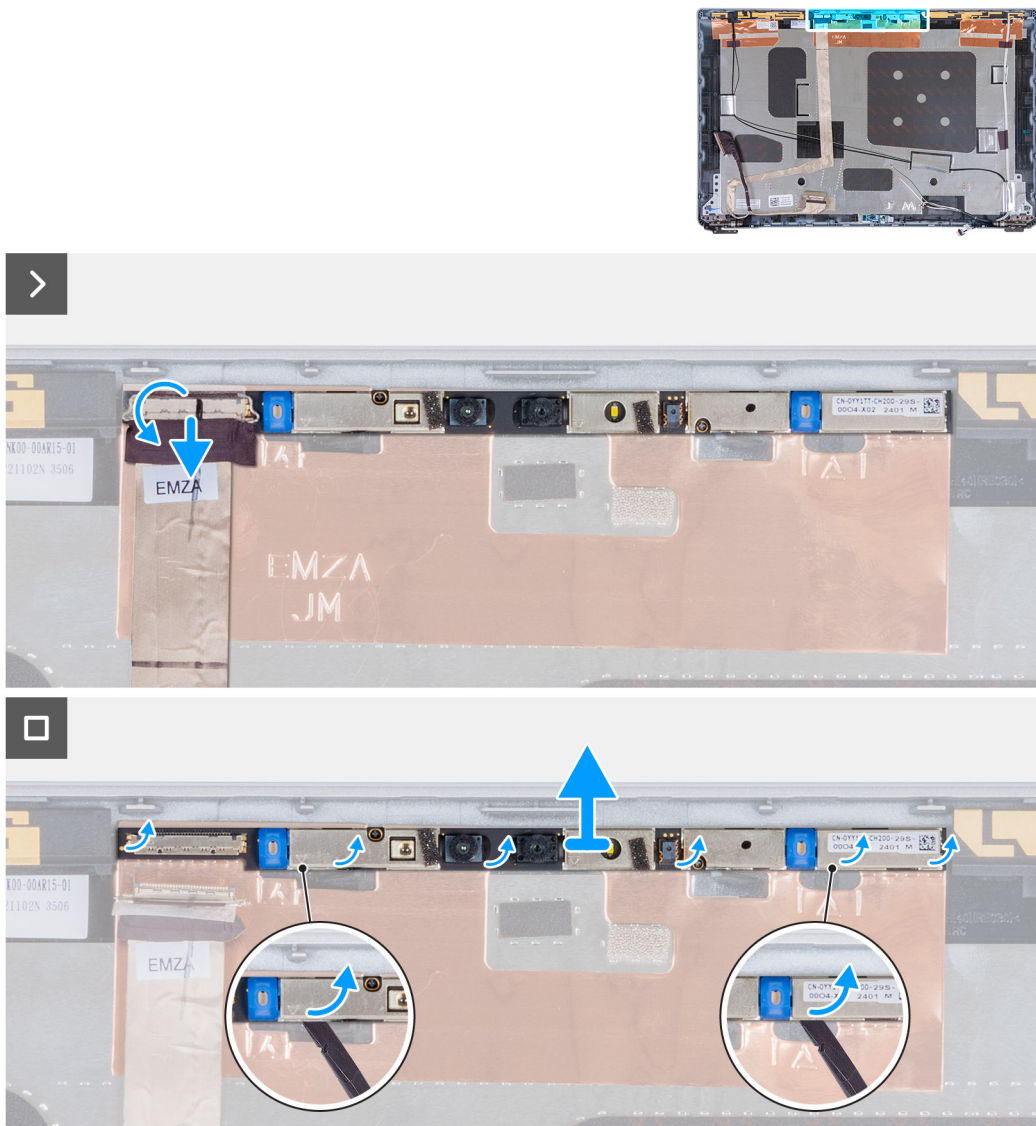

Figure 84. Removing the camera module

Steps

1. Peel the tape that secures the camera cable to the display back cover.
2. Disconnect the camera cable from the camera.
3. Carefully pry up the camera module starting from the prying point at the bottom edge of the camera module.
4. Lift the camera module from the display back cover.

Installing the camera module

CAUTION: The information in this installation section is intended for authorized service technicians only.

Prerequisites

If you are replacing a component, remove the existing component before performing the installation process.

About this task

The following images indicate the location of the camera module and provide a visual representation of the installation procedure.

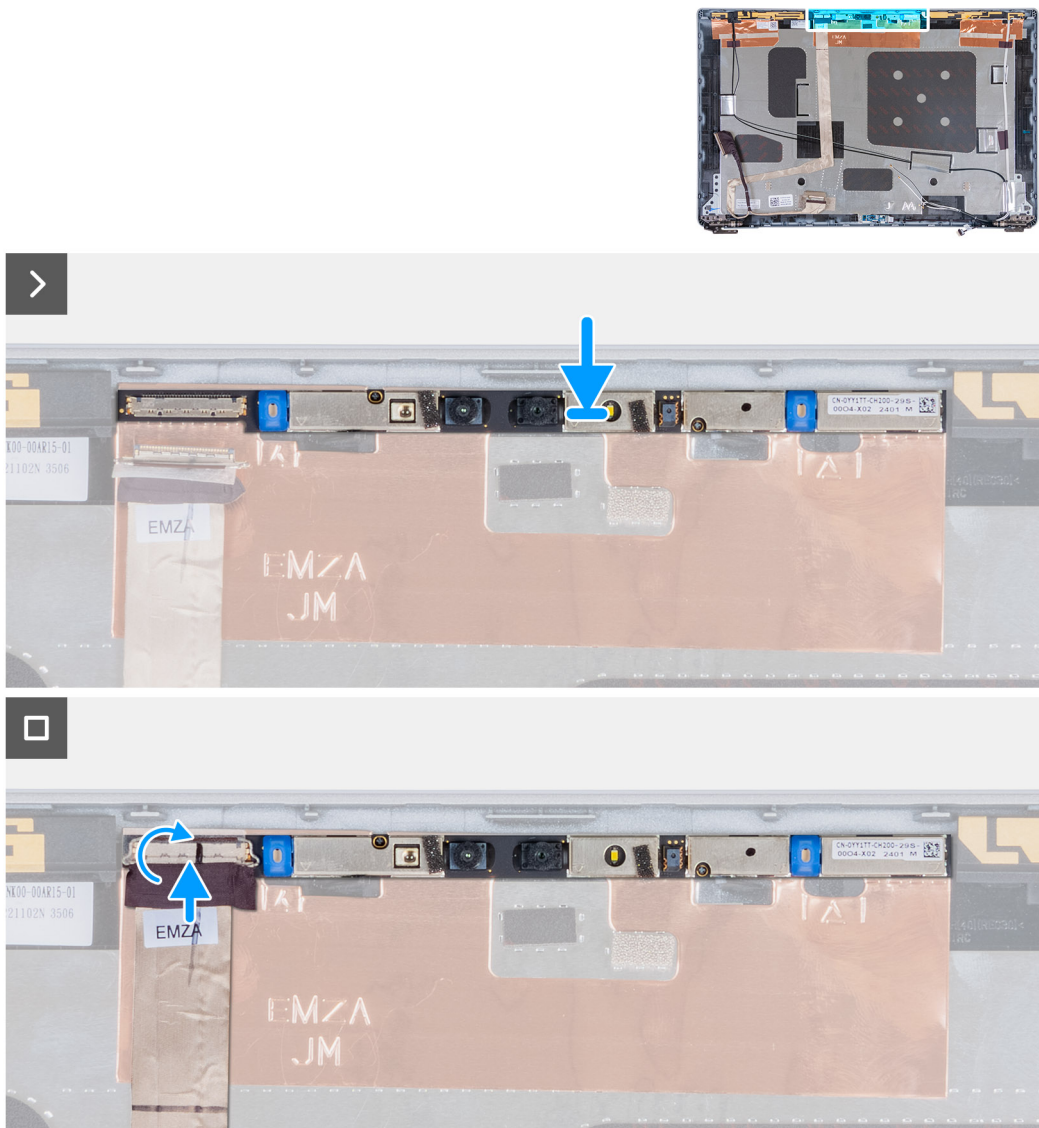

Figure 85. Installing the camera module

Steps

1. Align and place the camera module into the slot on the display back cover.
2. Connect the camera module cable to the connector on the camera module.
3. Adhere the tape to secure the camera cable to the camera.

Next steps

1. Install the [display panel](#).
2. Install the [display bezel](#).
3. Install the [display assembly](#).
4. Install the [wireless card](#).
5. Install the [4G WWAN card](#) or [5G WWAN card](#), as applicable.
6. Install the [base cover](#).
7. Install the [SIM card](#).
8. Follow the procedure in [After working inside your computer](#).

Display hinges

Removing the display hinges

CAUTION: The information in this removal section is intended for authorized service technicians only.

Prerequisites

1. Follow the procedure in [Before working inside your computer](#).
2. Remove the [SIM card](#).
3. Remove the [base cover](#).
4. Remove the [4G WWAN card](#) or [5G WWAN card](#), as applicable.
5. Remove the [wireless card](#).
6. Remove the [display assembly](#).
7. Remove the [display bezel](#).
8. Remove the [display panel](#).

About this task

The following images indicate the location of the display hinges and provide a visual representation of the removal procedure.

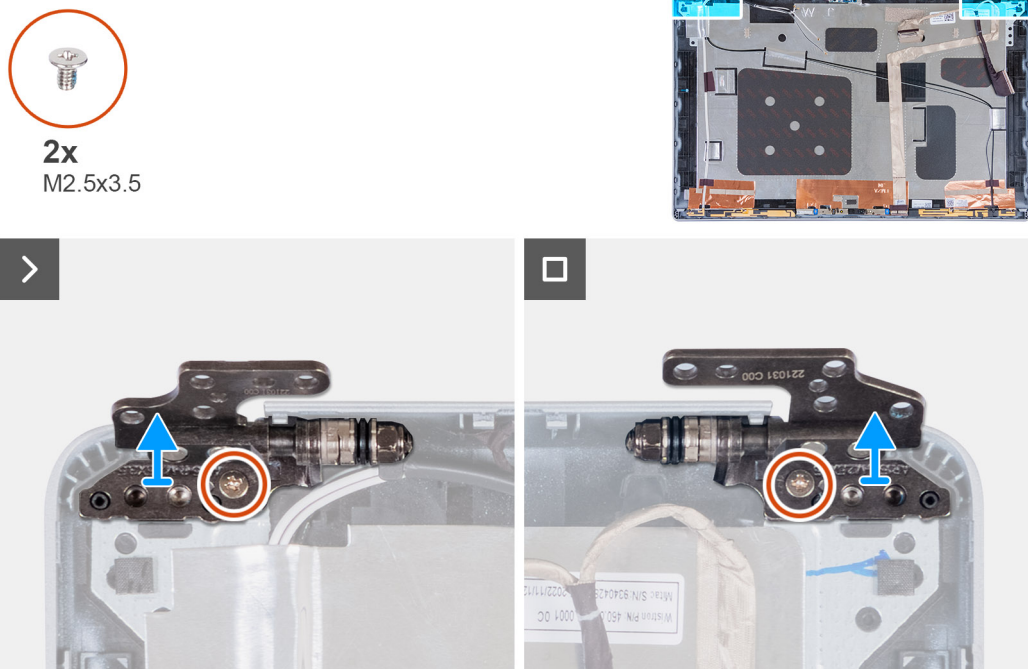

Figure 86. Removing the display hinges

Steps

1. Remove the screw (M2.5x3.5) that secures the right hinge to the display back cover.
2. Lift and remove the right hinge from the display back cover.
3. Remove the screw (M2.5x3.5) that secures the left hinge to the display back cover.
4. Lift and remove the left hinge from the display back cover.

Installing the display hinges

CAUTION: The information in this installation section is intended for authorized service technicians only.

Prerequisites

If you are replacing a component, remove the existing component before performing the installation process.

About this task

The following images indicate the location of the display hinges and provide a visual representation of the installation procedure.

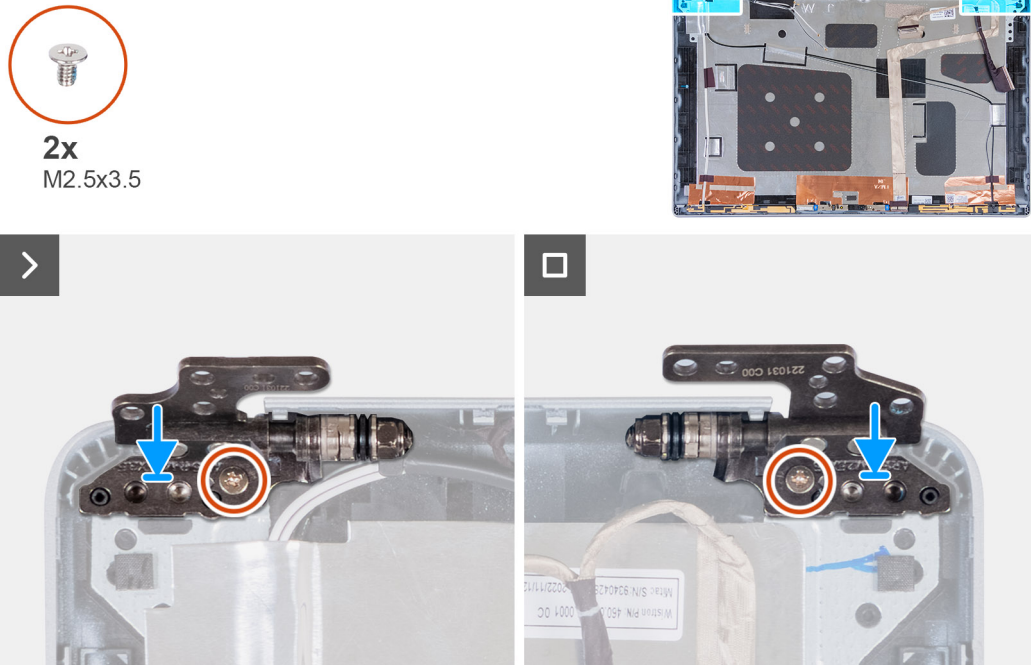

Figure 87. Installing the display hinges

Steps

1. Align the screw hole on the left hinge with the screw hole on the display back cover.
2. Replace the screw (M2.5x3.5) that secures the left hinge to the display back cover.
3. Align the screw hole on the right hinge with the screw hole on the display back cover.
4. Replace the screw (M2.5x3.5) that secures the right hinge to the display back cover.

Next steps

1. Install the [display panel](#).
2. Install the [display bezel](#).
3. Install the [display assembly](#).
4. Install the [wireless card](#).
5. Install the [4G WWAN card](#) or [5G WWAN card](#), as applicable.
6. Install the [base cover](#).
7. Install the [SIM card](#).
8. Follow the procedure in [After working inside your computer](#).

Display back cover

Removing the display back cover

CAUTION: The information in this removal section is intended for authorized service technicians only.

Prerequisites

1. Follow the procedure in [Before working inside your computer](#).
2. Remove the [SIM card](#).
3. Remove the [base cover](#).
4. Remove the [4G WWAN card](#) or [5G WWAN card](#), as applicable.
5. Remove the [wireless card](#).
6. Remove the [display assembly](#).
7. Remove the [display bezel](#).
8. Remove the [display panel](#).

About this task

The following images indicate the location of the display back cover and provide a visual representation of the removal procedure.

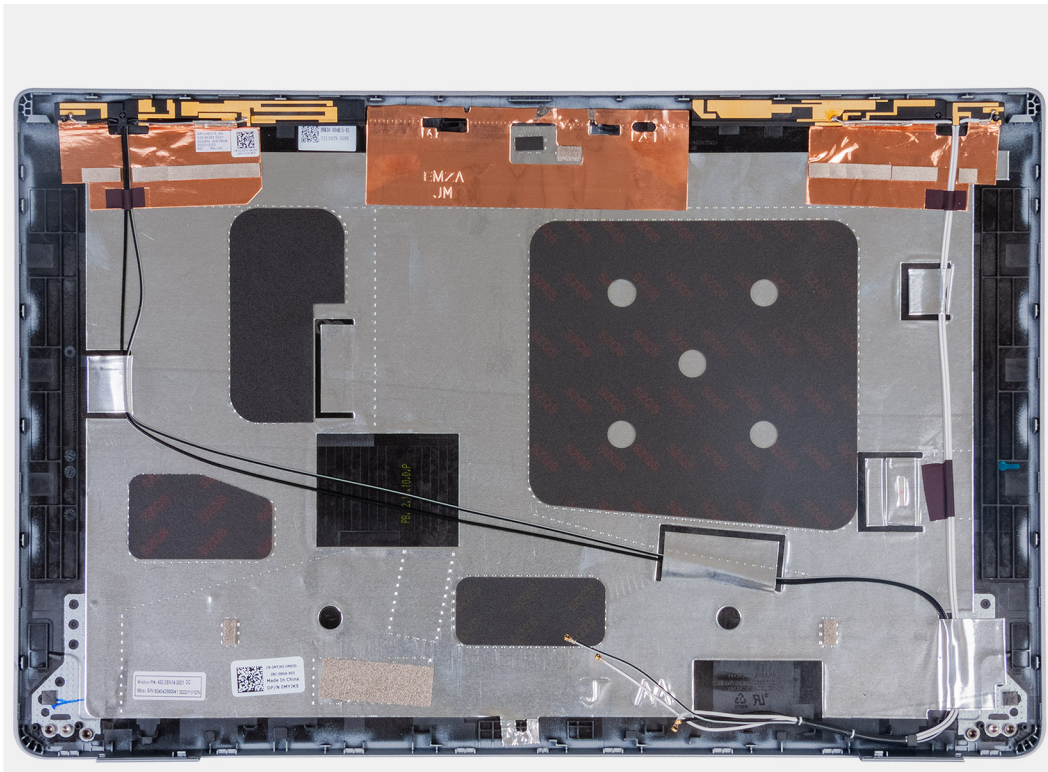

Figure 88. Removing the display back cover

Steps

Remove all the components mentioned in the pre-requisites to get the display back cover.

Installing the display back cover

⚠ CAUTION: The information in this installation section is intended for authorized service technicians only.

Prerequisites

If you are replacing a component, remove the existing component before performing the installation process.

About this task

The following images indicate the location of the display back cover and provide a visual representation of the installation procedure.

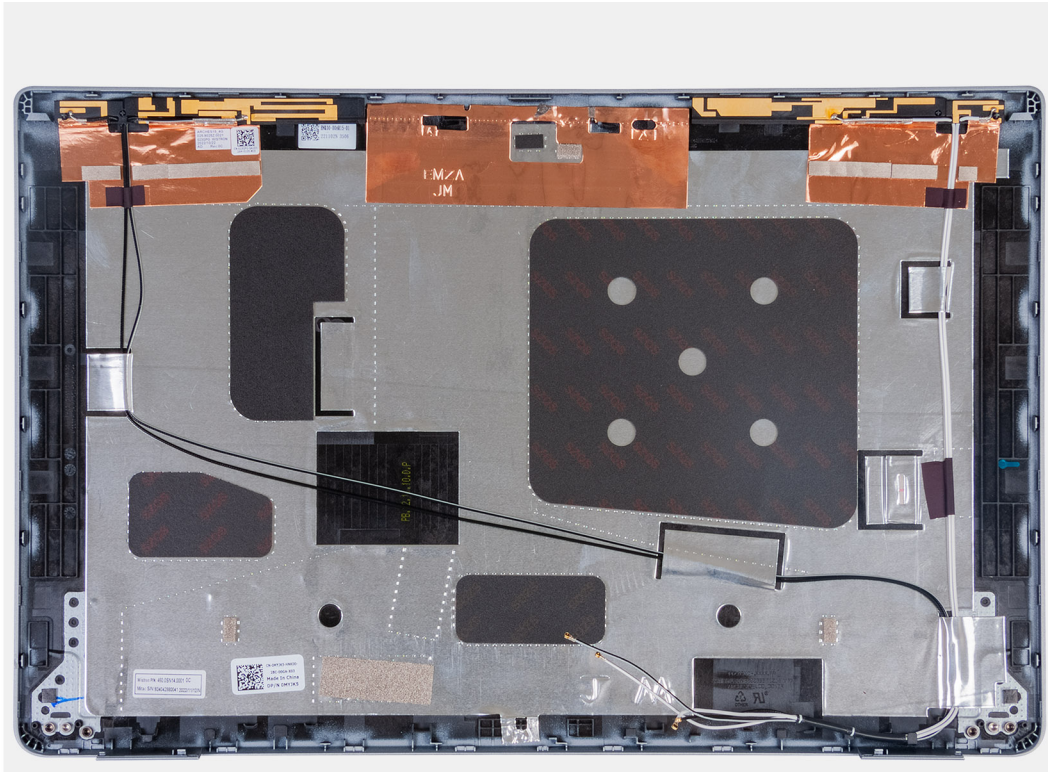

Figure 89. Installing the display back cover

Steps

Place the display back cover on a flat surface.

Next steps

1. Install the [display panel](#).
2. Install the [display bezel](#).
3. Install the [display assembly](#).
4. Install the [wireless card](#).
5. Install the [4G WWAN card](#) or [5G WWAN card](#), as applicable.
6. Install the [base cover](#).
7. Install the [SIM card](#).
8. Follow the procedure in [After working inside your computer](#).

Display cable

Removing the display cable

CAUTION: The information in this removal section is intended for authorized service technicians only.

Prerequisites

1. Follow the procedure in [Before working inside your computer](#).
2. Remove the [SIM card](#).
3. Remove the [base cover](#).
4. Remove the [4G WWAN card](#) or [5G WWAN card](#), as applicable.
5. Remove the [wireless card](#).
6. Remove the [display assembly](#).
7. Remove the [display bezel](#).

8. Remove the [display panel](#).

About this task

The following images indicate the location of the display cable and provide a visual representation of the removal procedure.



Figure 90. Removing the display cable

Steps

1. Peel the tape that secures the display cable to the display back cover.
2. Disconnect the display cable from the camera module.
3. Peel the display cable to release it from adhesive and lift the display cable off the display back cover.

Installing the display cable

CAUTION: The information in this installation section is intended for authorized service technicians only.

Prerequisites

If you are replacing a component, remove the existing component before performing the installation process.

About this task

The following images indicate the location of the display cable and provide a visual representation of the installation procedure.



Figure 91. Installing the display cable

Steps

1. Connect the display cable to the connector on the camera.
2. Adhere the display cable to the display back cover.
3. Adhere the tape that secures the display cable to the display back cover.

Next steps

1. Install the [display panel](#).
2. Install the [display bezel](#).
3. Install the [display assembly](#).
4. Install the [wireless card](#).
5. Install the [4G WWAN card](#) or [5G WWAN card](#), as applicable.
6. Install the [base cover](#).
7. Install the [SIM card](#).
8. Follow the procedure in [After working inside your computer](#).

Sensor board

Removing the sensor board

CAUTION: The information in this removal section is intended for authorized service technicians only.

Prerequisites

1. Follow the procedure in [Before working inside your computer](#).
2. Remove the [SIM card](#).
3. Remove the [base cover](#).
4. Remove the [4G WWAN card](#) or [5G WWAN card](#), as applicable.

5. Remove the [wireless card](#).
6. Remove the [display assembly](#).
7. Remove the [display bezel](#).

About this task

The following images indicate the location of the sensor board and provide a visual representation of the removal procedure.

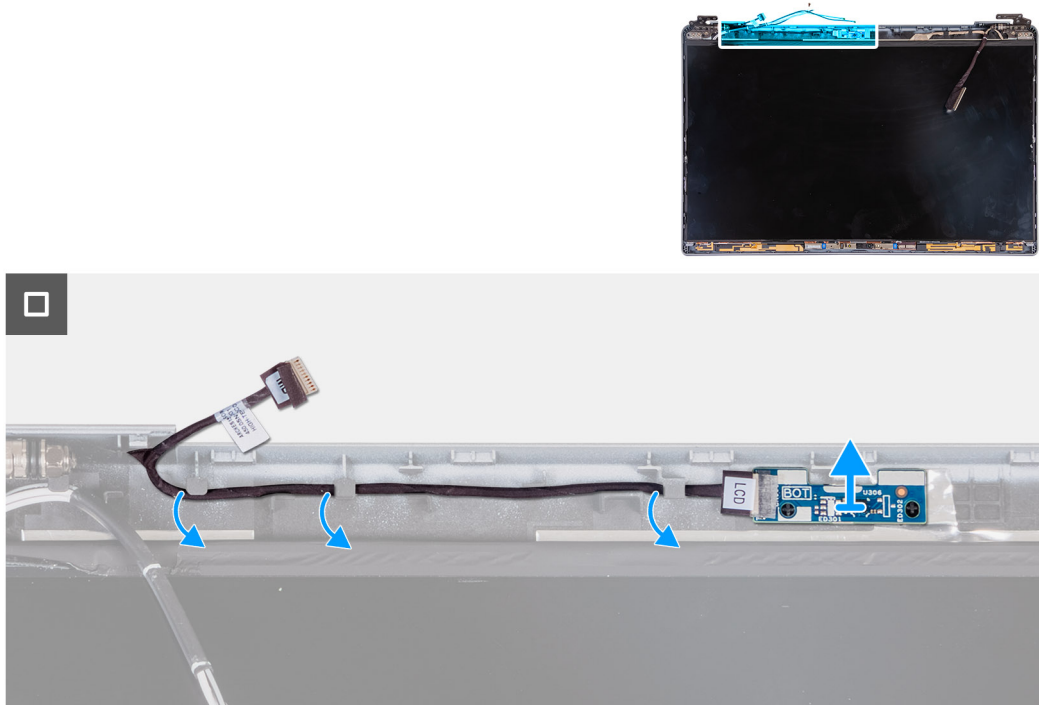

Figure 92. Removing the sensor board

Steps

1. Remove the sensor-board cable from the routing guides on the display back cover.
2. Lift the sensor board, along with its cable, off the display back cover.

Installing the sensor board

CAUTION: The information in this installation section is intended for authorized service technicians only.

Prerequisites

If you are replacing a component, remove the existing component before performing the installation process.

About this task

The following images indicate the location of the sensor board and provide a visual representation of the installation procedure.

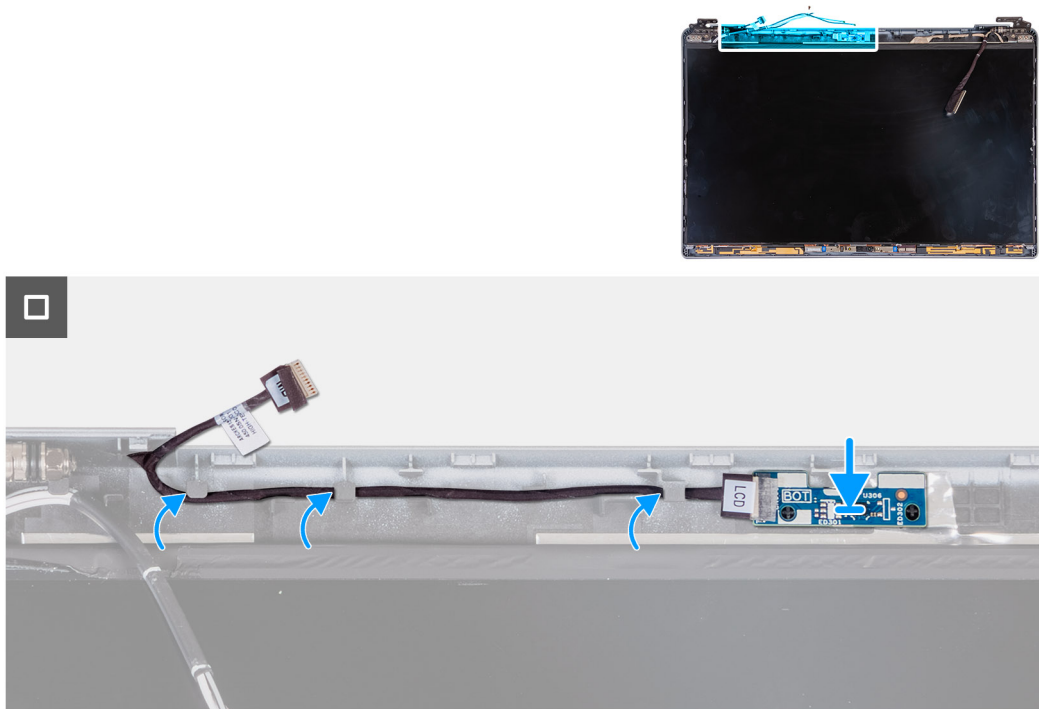

Figure 93. Installing the sensor board

Steps

1. Place the sensor board on its slot on the display back cover.
2. Route the sensor-board cable through the routing guides on the display back cover.

Next steps

1. Install the [display bezel](#).
2. Install the [display assembly](#).
3. Install the [wireless card](#).
4. Install the [4G WWAN card](#) or [5G WWAN card](#), as applicable.
5. Install the [base cover](#).
6. Install the [SIM card](#).
7. Follow the procedure in [After working inside your computer](#).

Fingerprint reader (optional)

Removing the fingerprint reader (optional)

CAUTION: The information in this removal section is intended for authorized service technicians only.

Prerequisites

1. Follow the procedure in [Before working inside your computer](#).
2. Remove the [SIM card](#).
3. Remove the [base cover](#).
4. Remove the [battery](#).
5. Remove the [assembly-inner frame](#).

About this task

The following images indicate the location of the fingerprint reader and provide a visual representation of the removal procedure.

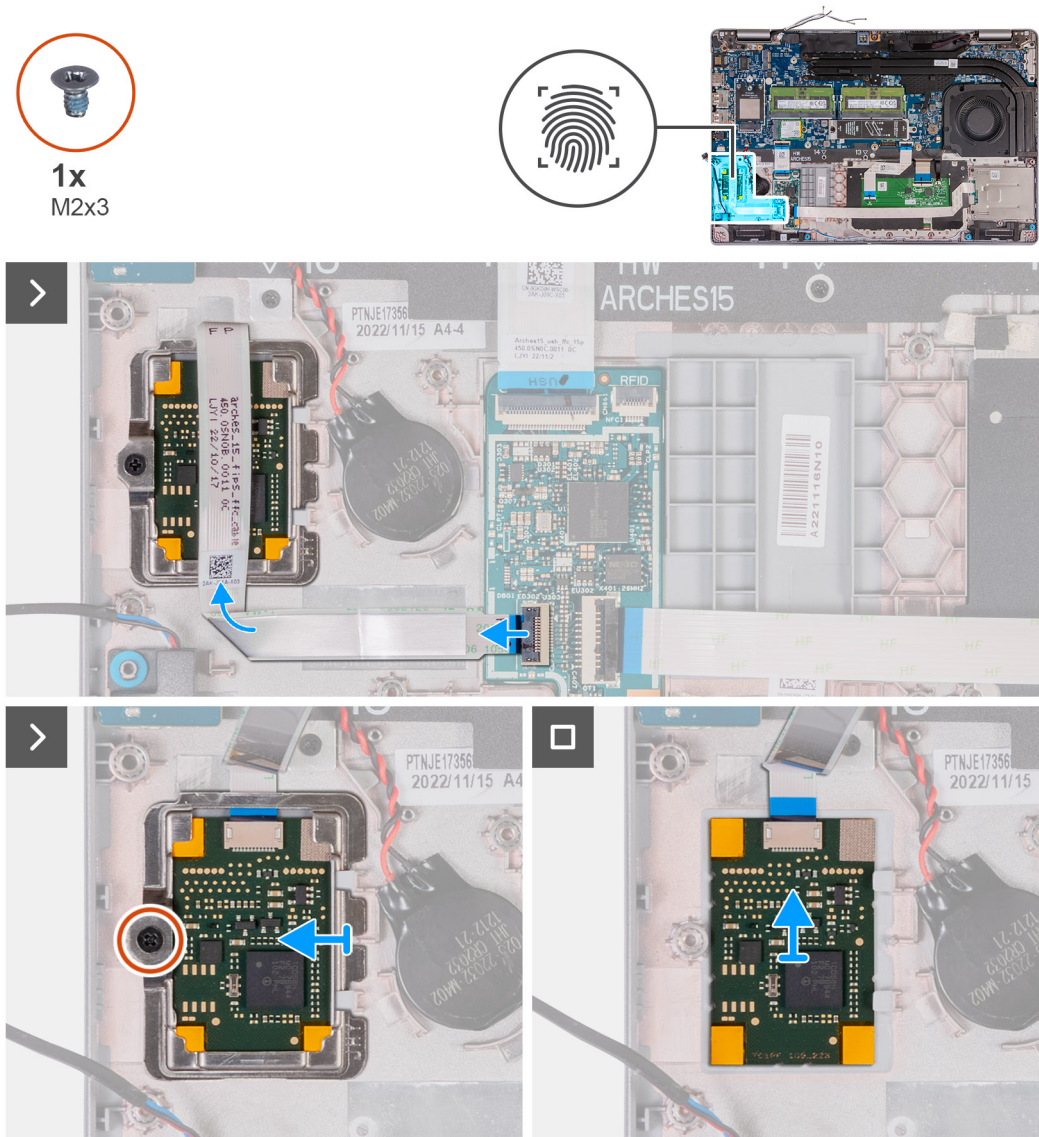

Figure 94. Removing the fingerprint reader

Steps

1. Lift the latch and disconnect the fingerprint-reader cable from the connector on the USH board.
2. Move the fingerprint-reader cable away from the fingerprint reader so that the cable is not covering the fingerprint reader.
3. Remove the screw (M2x3) that secures the fingerprint-reader bracket to the palm-rest assembly.
4. Slide and remove the fingerprint-reader bracket from the palm-rest assembly.
5. Lift the fingerprint reader, along with its cable, off the palm-rest assembly.

Installing the fingerprint reader (optional)

CAUTION: The information in this installation section is intended for authorized service technicians only.

Prerequisites

If you are replacing a component, remove the existing component before performing the installation process.

About this task

The following images indicate the location of the fingerprint reader and provide a visual representation of the installation procedure.

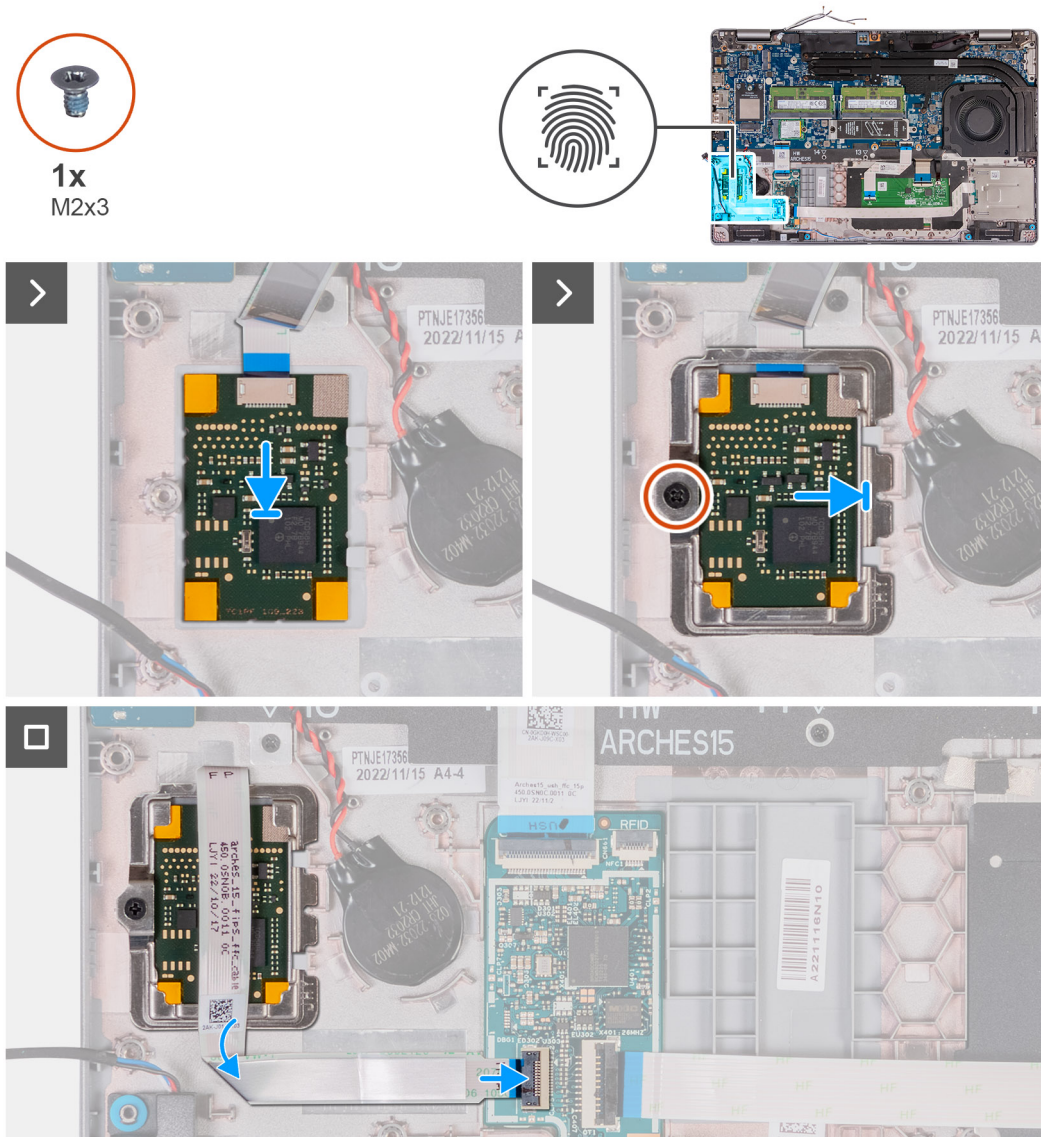

Figure 95. Installing the fingerprint reader

Steps

1. Align and place the fingerprint reader on its slot on the palm-rest assembly.
2. Slide the fingerprint-reader bracket on its slot on the palm-rest assembly.
3. Replace the screw (M2x3) that secures the fingerprint reader to the palm-rest assembly.
4. Connect the fingerprint-reader cable to the connector on the USH board and close the latch.

Next steps

1. Install the [assembly-inner frame](#).
2. Install the [battery](#).
3. Install the [base cover](#).
4. Install the [SIM card](#).
5. Follow the procedure in [After working inside your computer](#).

Smart-card reader

Removing the smart-card reader

CAUTION: The information in this removal section is intended for authorized service technicians only.

NOTE: The smart-card reader is available only on certain configurations.

Prerequisites

1. Follow the procedure in [Before working inside your computer](#).
2. Remove the [SIM card](#).
3. Remove the [base cover](#).
4. Remove the [wireless card](#).
5. Remove the [4G WWAN card](#) or [5G WWAN card](#), as applicable.
6. Remove the [battery](#).
7. Remove the [assembly-inner frame](#).

About this task

The following images indicate the location of the smart-card reader and provide a visual representation of the removal procedure.

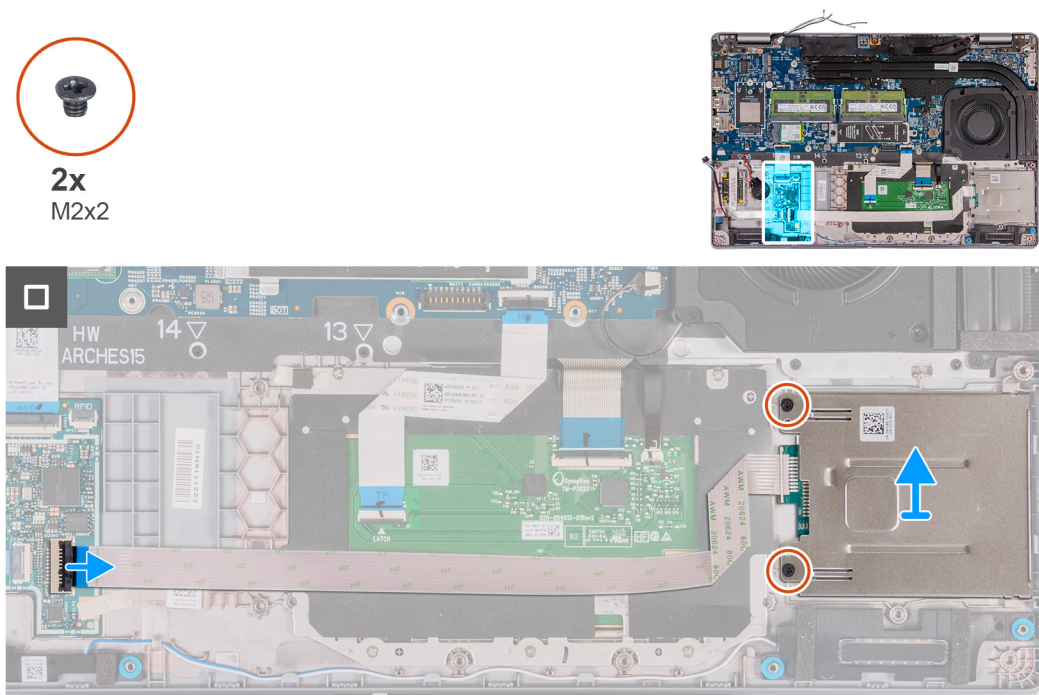

Figure 96. Removing the smart-card reader

Steps

1. Lift the latch and disconnect the smart-card reader cable from the connector on the USH board.
2. Remove the two screws (M2x2) that secure the smart-card reader to the palm-rest assembly.
3. Lift the smart-card reader, along with its cable, off the palm-rest assembly.

Installing the smart-card reader

CAUTION: The information in this installation section is intended for authorized service technicians only.

NOTE: The smart-card reader is available only on certain configurations.

Prerequisites

If you are replacing a component, remove the existing component before performing the installation process.

About this task

The following images indicate the location of the smart card reader and provide a visual representation of the installation procedure.

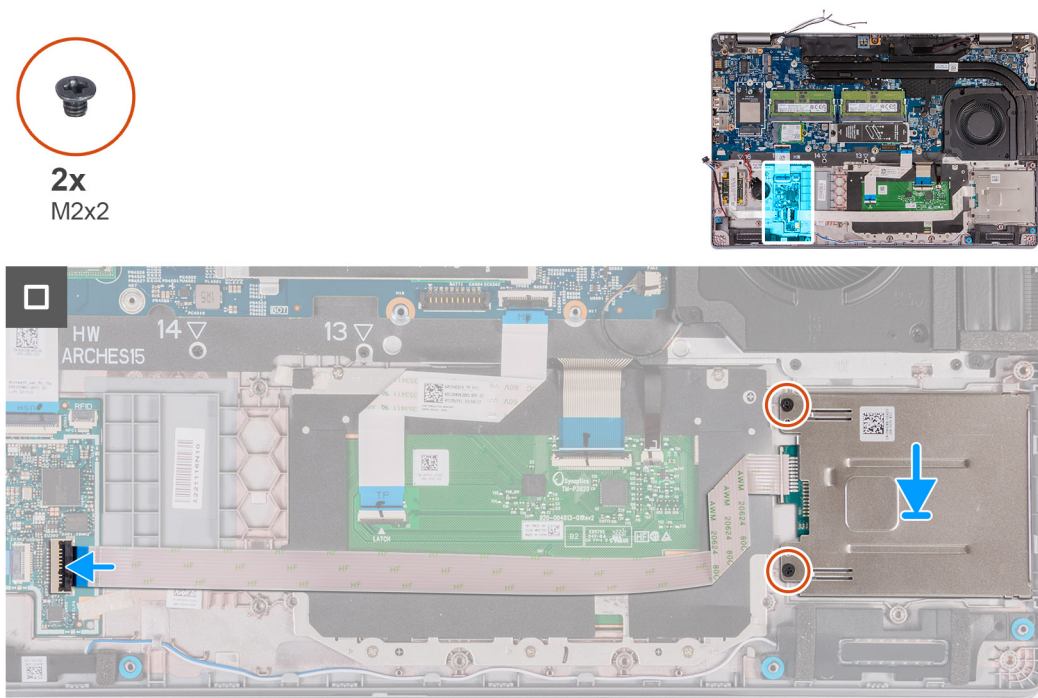

Figure 97. Installing the smart-card reader

Steps

1. Align and place the smart-card reader on its slot on the palm-rest assembly.
2. Replace the two screws (M2x2) that adheres the smart-card reader to the palm-rest assembly.
3. Connect the smart-card cable to the connector on the USH board and close the latch.

Next steps

1. Install the [assembly-inner frame](#).
2. Install the [battery](#).
3. Install the [4G WWAN card](#) or [5G WWAN card](#), as applicable.
4. Install the [wireless card](#).
5. Install the [base cover](#).
6. Install the [SIM card](#).
7. Follow the procedure in [After working inside your computer](#).

Dummy SIM-card slot filler

Removing the dummy SIM-card slot filler

 **CAUTION:** The information in this removal section is intended for authorized service technicians only.

 **NOTE:** The dummy SIM-card slot filler is available only on certain configurations.

Prerequisites

1. Follow the procedure in [Before working inside your computer](#).
2. Remove the [SIM card](#).
3. Remove the [base cover](#).
4. Remove the [wireless card](#).
5. Remove the [memory modules](#).
6. Remove the [M.2 2230](#) or [M.2 2280](#) SSD from slot 1, as applicable.
7. Remove the [M.2 2230](#) SSD from slot 2, if applicable.
8. Remove the [battery](#).
9. Remove the [assembly-inner frame](#).
10. Remove the [system board](#).

 **NOTE:** The system board can be removed with the heat sink attached in order to simplify the procedure and preserve the thermal bond between the system board and heat sink.

11. Remove the [display assembly](#).
12. Remove the [smart-card reader](#).
13. Remove the [fingerprint reader](#), if applicable.

About this task

 **NOTE:** For models shipped with wireless card only, the dummy SIM-card slot filler is a separate service part and is not included with a replacement palm rest. As a result, the dummy SIM-card slot filler must be removed and then reinstalled when replacing the palm-rest assembly.

The following images indicate the dummy SIM-card slot filler and provide a visual representation of the dummy SIM-card slot filler removal procedure.

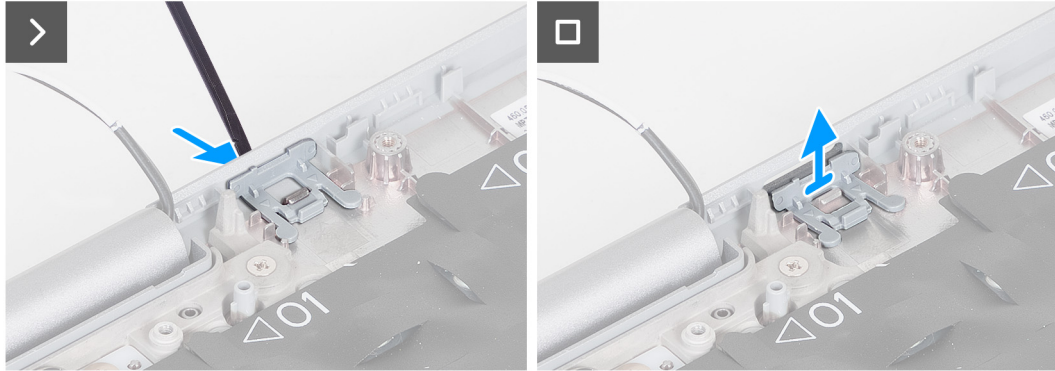
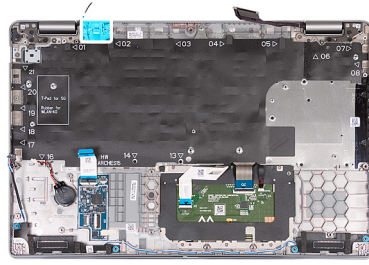

Figure 98. Removing the dummy SIM-card slot filler

Steps

1. Using a scribe, push the dummy SIM-card slot filler from the top side of the palm-rest assembly.
2. Gently lift the dummy SIM-card slot filler out of the palm-rest assembly.

Installing the dummy SIM-card slot filler

CAUTION: The information in this installation section is intended for authorized service technicians only.

NOTE: The dummy SIM-card slot filler is available only on certain configurations.

Prerequisites

If you are replacing a component, remove the necessary component before the installation procedure.

About this task

The following images indicate the location of the dummy SIM-card slot filler and provide a visual representation of the dummy SIM-card slot filler installation procedure.

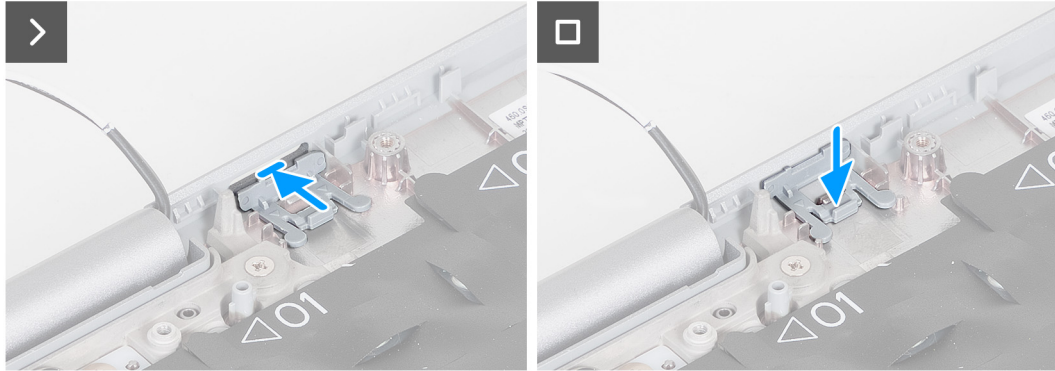
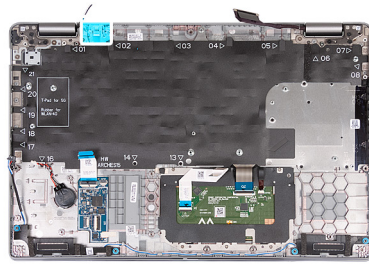

Figure 99. Installing the dummy SIM-card slot filler

Steps

1. Place the dummy SIM-card slot filler into its compartment on the palm rest.
i **NOTE:** Ensure that the dummy SIM-card slot filler is aligned with the ribs on the palm-rest assembly.
2. Press the dummy SIM-card slot filler until it clicks into place and ensure it fits securely into the SIM card slot.

Next steps

1. Install the [fingerprint reader](#), if applicable.
2. Install the [smart card reader](#).
3. Install the [display assembly](#).
4. Install the [system board](#).
i **NOTE:** The system board can be removed and installed with the heat sink attached in order to simplify the procedure and preserve the thermal bond between the system board and heat sink.
5. Install the [assembly inner frame](#).
6. Install the [battery](#).
7. Install the [heat sink \(discrete GPU\)](#) or [heat sink \(integrated GPU\)](#), as applicable.
8. Install the [M.2 2230 SSD](#) in slot 2, if applicable.
9. Install the [M.2 2230](#) or [M.2 2280 SSD](#) in slot 1, as applicable.
10. Install the [memory modules](#).
11. Install the [wireless card](#).
12. Install the [base cover](#).
13. Install the [SIM card](#).
14. Follow the procedure in [After working inside your computer](#).

Palm-rest assembly

Removing the palm-rest assembly

⚠ CAUTION: The information in this removal section is intended for authorized service technicians only.

Prerequisites

1. Follow the procedure in [Before working inside your computer](#).
2. Remove the [SIM card](#).
3. Remove the [base cover](#).
4. Remove the [4G WWAN card](#) or [5G WWAN card](#), as applicable.
5. Remove the [wireless card](#).
6. Remove the [memory modules](#).
7. Remove the [M.2 2230](#) or [M.2 2280 SSD](#) from slot 1, as applicable.
8. Remove the [M.2 2230 SSD](#) from slot 2, if applicable.
9. Remove the [battery](#).
10. Remove the [assembly-inner frame](#).
11. Remove the [system board](#).

NOTE: The system board can be removed with the heat sink attached in order to simplify the procedure and preserve the thermal bond between the system board and heat sink.

12. Remove the [display assembly](#).
13. Remove the [smart-card reader](#).
14. Remove the [fingerprint reader](#), if applicable.

About this task

NOTE: When replacing the palm-rest assembly, transfer the dummy SIM filler to the new palm-rest assembly.

The following image indicates the location of the palm-rest assembly and provides a visual representation of the removal procedure.

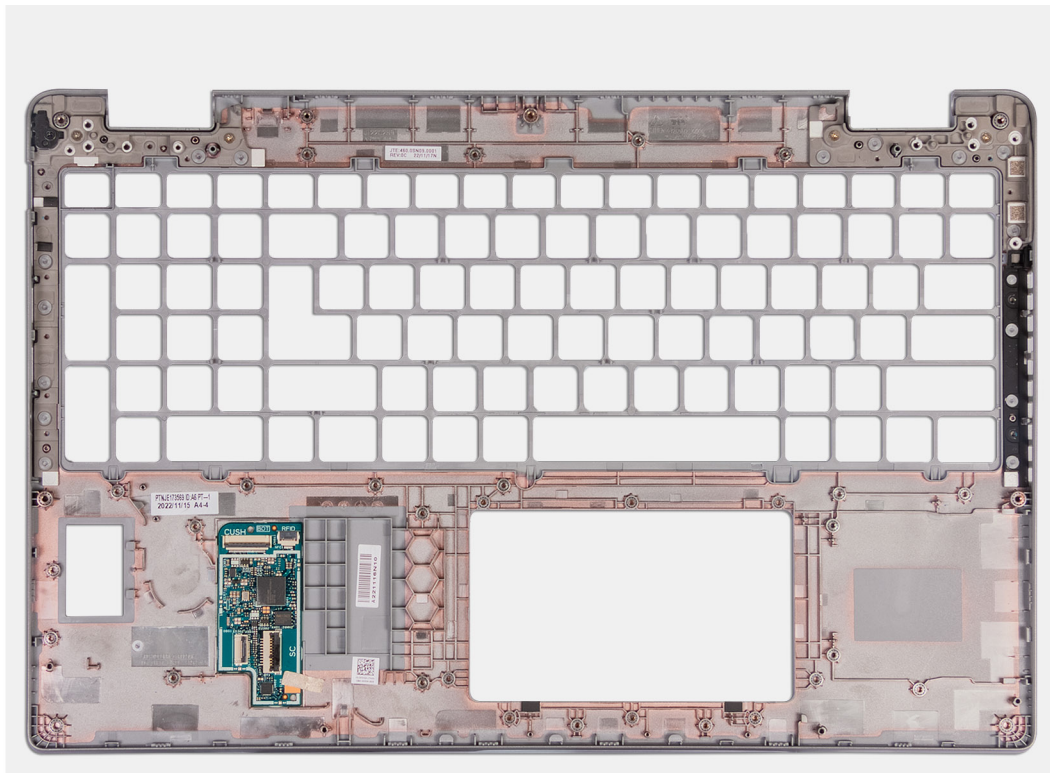

Figure 100. Removing the palm-rest assembly

Steps

Remove all the components mentioned in the pre-requisites to get the palm-rest assembly.

Installing the palm-rest assembly

CAUTION: The information in this installation section is intended for authorized service technicians only.

Prerequisites

If you are replacing a component, remove the existing component before performing the installation process.

About this task

The following image indicates the location of the palm-rest assembly and provides a visual representation of the installation procedure.

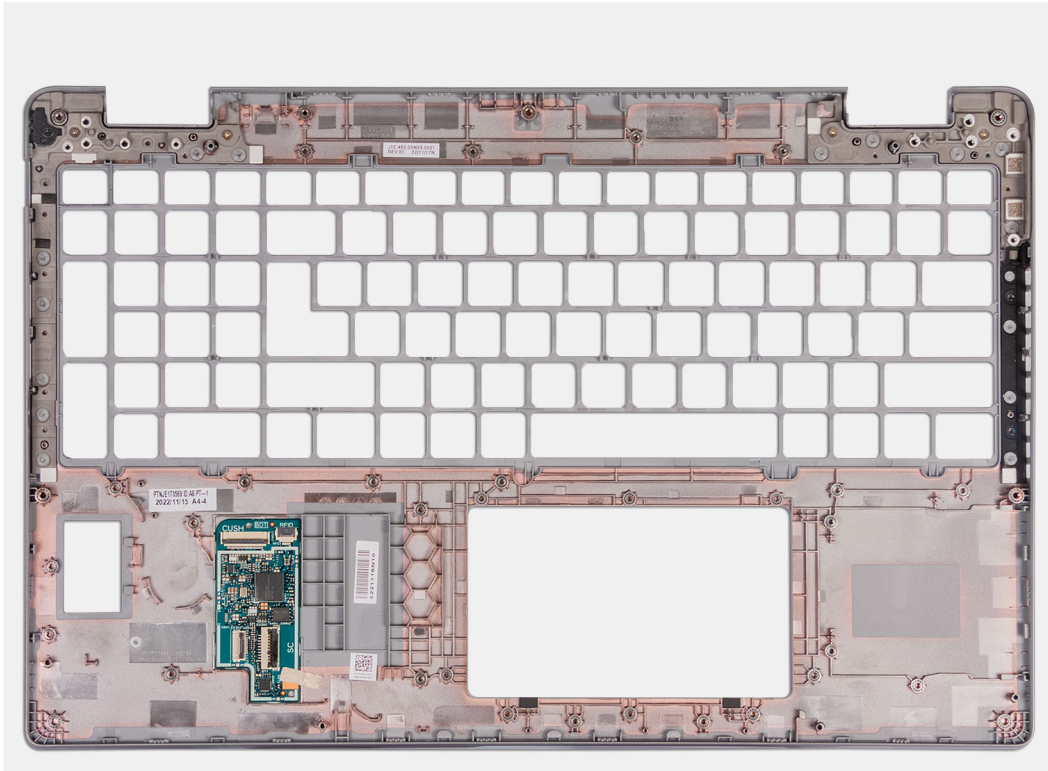

Figure 101. Installing the palm-rest assembly

Steps

Place the palm-rest assembly on a flat surface.

Next steps

1. Install the [fingerprint reader](#), if applicable.
2. Install the [smart card reader](#).
3. Install the [display assembly](#).
4. Install the [system board](#).

NOTE: The system board can be removed and installed with the heat sink attached in order to simplify the procedure and preserve the thermal bond between the system board and heat sink.

5. Install the [assembly inner frame](#).
6. Install the [battery](#).
7. Install the [heat sink \(discrete GPU\)](#) or [heat sink \(integrated GPU\)](#), as applicable.
8. Install the [M.2 2230 SSD](#) in slot 2, if applicable.
9. Install the [M.2 2230](#) or [M.2 2280 SSD](#) in slot 1, as applicable.
10. Install the [memory modules](#).

11. Install the [wireless card](#).
12. Install the [4G WWAN card](#) or [5G WWAN card](#), as applicable.
13. Install the [base cover](#).
14. Install the [SIM card](#).
15. Follow the procedure in [After working inside your computer](#).

Software

This chapter details the supported operating systems along with instructions on how to install the drivers.

Operating system

Your Precision 3590 supports the following operating systems:

- Windows 11 Home
- Windows 11 Pro
- Ubuntu Linux 22.04 LTS

Drivers and downloads

When troubleshooting, downloading, or installing drivers, it is recommended that you read the Dell Knowledge Base article [Drivers and Downloads FAQs 000123347](#).

BIOS Setup

CAUTION: Unless you are an expert computer user, do not change the settings in the BIOS Setup. Certain changes can make your computer work incorrectly.

NOTE: Depending on the computer and the installed devices, the options that are listed in this section may or may not be displayed.

NOTE: Before you change the settings in BIOS Setup, it is recommended that you note down the original settings for future reference.

Use BIOS Setup for the following purposes:

- Get information about the hardware installed in your computer, such as the amount of RAM and the size of the storage device.
- Change the system configuration information.
- Set or change a user-selectable option, such as the user password, type of hard drive installed, and enable or disable base devices.

Entering BIOS Setup program

About this task

Turn on (or restart) your computer and press F2 immediately.

Navigation keys

NOTE: For most of the BIOS Setup options, changes that you make are recorded but do not take effect until you restart the computer.

Table 41. Navigation keys

Keys	Navigation
Up arrow	Moves to the previous field.
Down arrow	Moves to the next field.
Enter	Selects a value in the selected field (if applicable) or follows the link in the field.
Spacebar	Expands or collapses a drop-down list, if applicable.
Tab	Moves to the next focus area.
Esc	Moves to the previous page until you view the main screen. Pressing Esc in the main screen displays a message that prompts you to save any unsaved changes and restart the computer.

F12 One Time Boot menu

To enter the One Time Boot menu, turn on your computer, and then press F12 immediately.

NOTE: If you are unable to enter the One Time Boot menu, repeat the above action.

The One Time Boot menu displays the devices that you can boot from and also display the options to start diagnostics. The boot menu options are:

- Removable Drive (if available)
- STXXXX Drive (if available)

 **NOTE:** XXX denotes the SATA drive number.

- Optical Drive (if available)
- SATA Hard Drive (if available)
- Diagnostics

The One Time Boot menu screen also displays the option to access BIOS Setup.

View Advanced Setup options

About this task

Some BIOS Setup options are only visible by enabling **Advanced Setup** mode, which is disabled by default.

 **NOTE:** BIOS Setup options, including **Advanced Setup** options, are described in [System setup options](#).

To enable Advanced Setup

Steps

1. Enter BIOS Setup.
The Overview menu appears.
2. Click the **Advanced Setup** option to move it to the **ON** mode.
Advanced BIOS Setup options are visible.

View Service options

About this task

Service options are hidden by default and only visible by entering a hotkey command.

 **NOTE:** Service options are described in [System setup options](#).

To view Service options:

Steps

1. Enter BIOS Setup.
The Overview menu appears.
2. Enter the hotkey combination **Ctrl +Alt + s** to view the **Service** options.
Service options are visible.

System Setup options

 **NOTE:** For most of the System Setup options, changes that you make are recorded but do not take effect until you restart the computer.

 **NOTE:** Depending on your computer and its installed devices, the items that are listed in this section may differ.

Table 42. System Setup options—Overview menu

Overview

Precision 3590

Table 42. System Setup options—Overview menu (continued)

Overview

BIOS Version	Displays the BIOS version number.
Service Tag	Displays the Service Tag of the computer.
Asset Tag	Displays the Asset Tag of the computer.
Manufacture Date	Displays the manufacture date of the computer.
Ownership Date	Displays the ownership date of the computer.
Express Service Code	Displays the Express Service Code of the computer.
Ownership Tag	Displays the Ownership Tag of the computer.
Signed Firmware Update	Displays whether the Signed Firmware Update is enabled on your computer. By default, the Signed Firmware Update option is enabled.  NOTE: To view this option, enable Service options as described in View Service options .

BATTERY

Battery Type	Displays whether the battery is Primary or Secondary on your computer.
Battery Level	Displays the battery level of the computer.
Battery State	Displays the battery state of the computer.
Health	Displays the battery health of the computer.
AC Adapter	Displays whether an AC adapter is connected. If connected, displays the type of AC adapter that is connected.
Battery Life Type	Displays whether the battery life type is Standard, Long Life Cycle 1.0, or Long Life Cycle 2.0.

PROCESSOR





Processor Type	Displays the processor type.
Maximum Clock Speed	Displays the maximum processor clock speed.  NOTE: To view this option, enable Advanced Setup mode as described in View Advanced Setup options .
Minimum Clock Speed	Displays the minimum processor clock speed.  NOTE: To view this option, enable Advanced Setup mode as described in View Advanced Setup options .
Current Clock Speed	Displays the current processor clock speed.  NOTE: To view this option, enable Advanced Setup mode as described in View Advanced Setup options .
Core Count	Displays the number of cores on the processor.
Processor ID	Displays the processor identification code.
Processor L2 Cache	Displays the Processor L2 Cache size
Processor L3 Cache	Displays the Processor L3 Cache size.
Microcode Version	Displays the microcode version.  NOTE: To view this option, enable Advanced Setup mode as described in View Advanced Setup options .
Intel Hyper-Threading Capable	Displays whether the processor is Hyper-Threading (HT) capable.  NOTE: To view this option, enable Advanced Setup mode as described in View Advanced Setup options .

Table 42. System Setup options—Overview menu (continued)

Overview	
64-Bit Technology	Displays whether 64-bit technology is used. Default value: Yes.
MEMORY	
Memory Installed	Displays the total computer memory installed.
Memory Available	Displays the total computer memory available.
Memory Speed	Displays the memory speed. i NOTE: To view this option, enable Advanced Setup mode as described in View Advanced Setup options .
Memory Channel Mode	Displays single or dual channel mode. i NOTE: To view this option, enable Advanced Setup mode as described in View Advanced Setup options .
Memory Technology	Displays the technology that is used for the memory.
DIMM_SLOT	Displays the DIMM slot memory information
DEVICES	
Panel Type	Displays the panel type of the computer.
Panel Revision	Displays the panel revision of the computer
Video Controller	Displays the video controller type of the computer.
Video Memory	Displays the video memory information of the computer.
Wi-Fi Device	Displays the wireless device information of the computer.
Native Resolution	Displays the native resolution of the computer.
Video BIOS Version	Displays the video BIOS version of the computer. i NOTE: To view this option, enable Advanced Setup mode as described in View Advanced Setup options .
Audio Controller	Displays the audio controller information of the computer.
Bluetooth Device	Displays the Bluetooth device information of the computer.
LOM MAC Address	Displays the LOM MAC address of the computer.
Pass Through MAC Address	Displays the MAC address of the video pass-through.
Cellular Device	Displays if the cellular device is installed.
dGPU Video Controller	Displays the name of the discrete video controller.

Table 43. System Setup options—Boot Configuration menu

Boot Configuration	
Boot Sequence	Displays the boot sequence.
Boot Mode: UEFI only	Displays the boot mode of the computer. i NOTE: To view this option, enable Service options as described in View Service options .
Enable PXE Boot Priority	Enables or disables PXE Boot Priority.
Secure Digital (SD) Card Boot	Enables or disables read-only boot from Secure Digital (SD) card. By default, the Secure Digital (SD) Card Boot option is disabled.

Table 43. System Setup options—Boot Configuration menu (continued)

Boot Configuration	
	<p>i NOTE: To view this option, enable Advanced Setup mode as described in View Advanced Setup options.</p>
Secure Boot	<p>Secure Boot is a method of guaranteeing the integrity of the boot path by performing additional validation of the operating system and PCI add-in cards. The computer stops booting to the operating system when a component is not authenticated during the boot process. Secure Boot can be enabled in BIOS setup or using management interfaces like Dell Command Configure, but can only be disabled from BIOS setup.</p>
Enable Secure Boot	<p>Enables the computer to boot using only validated boot software.</p> <p>By default, this Enable Secure Boot option is disabled. For additional security, Dell Technologies recommends keeping the Secure Boot option enabled to ensure that the UEFI firmware validates the operating system during the boot process.</p> <p>i NOTE: To view this option, enable Advanced Setup mode as described in View Advanced Setup options.</p> <p>i NOTE: To enable Secure Boot, the computer is required to be in UEFI boot mode and the Enable Legacy Option ROMs option is required to be turned off.</p>
Enable Microsoft UEFI CA	<p>When disabled, the UEFI CA is removed from the BIOS UEFI Secure Boot database.</p> <p>By default, the Enable Microsoft UEFI CA option is enabled.</p> <p>i NOTE: If you disable the Enable Microsoft UEFI CA option, you will be prompted to confirm the change when the computer restarts.</p> <p>i NOTE: When disabled, the Microsoft UEFI CA could render your computer unable to boot, computer graphics may not function, some devices may not function properly, and the computer could become unrecoverable.</p> <p>For additional security, Dell Technologies recommends keeping the Microsoft UEFI CA option enabled to ensure the broadest compatibility with devices and operating systems.</p>
Secure Boot Mode	<p>Enables or disables the Secure Boot operation mode.</p> <p>By default, the Deployed Mode is selected. Deployed Mode should be selected for normal operation of Secure Boot.</p> <p>i NOTE: To view this option, enable Advanced Setup mode as described in View Advanced Setup options.</p>
Expert Key Management	
Enable Custom Mode	<p>Enables or disables the keys in the PK, KEK, db, and dbx security key databases to be modified.</p> <p>By default, the Enable Custom Mode option is disabled.</p> <p>i NOTE: If you enable the Enable Custom Mode option, you will be prompted to confirm the change when the computer restarts.</p> <p>i NOTE: To view this option, enable Advanced Setup mode as described in View Advanced Setup options.</p>
Custom Mode Key Management	<p>Selects the custom values for expert key management.</p> <p>By default, the PK option is selected.</p>

Table 43. System Setup options—Boot Configuration menu (continued)

Boot Configuration	
	<p>i NOTE: If you change the Custom Mode Key Management setting, you will be prompted to confirm the change when the computer restarts.</p> <p>i NOTE: To view this option, enable Advanced Setup mode as described in View Advanced Setup options.</p>

Table 44. System Setup options—Integrated Devices menu

Integrated Devices	
Date/Time	
Date	Sets the computer date in MM/DD/YYYY format. Changes to the date format take effect immediately.
Time	Sets the computer time in HH/MM/SS 24-hour format. You can switch between a 12-hour or 24-hour clock. Changes to the time format take effect immediately.
Camera	
Enable Camera	<p>Enables the camera.</p> <p>By default, the Enable Camera option is enabled.</p> <p>i NOTE: Depending on the configuration ordered, the camera setup option may not be available.</p>
Audio	
Enable Audio	<p>Enables all integrated audio controller.</p> <p>By default, all the options are enabled.</p>
Enable Microphone	<p>Enables the microphone.</p> <p>By default, the Enable Microphone option is enabled.</p> <p>i NOTE: Depending on the configuration ordered, the microphone setup option may not be available.</p>
Enable Internal Speaker	<p>Enables the internal speaker.</p> <p>By default, the Enable Internal Speaker option is enabled.</p>
USB/Thunderbolt Configuration	
Enable External USB Ports	<p>Enables the external USB ports.</p> <p>By default, the Enable External USB Ports option is enabled.</p> <p>i NOTE: To view this option, enable Advanced Setup mode as described in View Advanced Setup options.</p>
Enable USB Boot Support	<p>Enables booting from USB mass storage devices that are connected to external USB ports.</p> <p>By default, the Enable USB Boot Support option is enabled.</p> <p>i NOTE: To view this option, enable Advanced Setup mode as described in View Advanced Setup options.</p>
Thunderbolt Adapter Configuration	
Enable Thunderbolt Technology Support	<p>Enables the associated ports and adapters for Thunderbolt Technology support.</p> <p>By default, the Enable Thunderbolt Technology Support option is enabled.</p> <p>i NOTE: To view this option, enable Advanced Setup mode as described in View Advanced Setup options.</p>

Table 44. System Setup options—Integrated Devices menu (continued)

Integrated Devices	
Enable Thunderbolt Boot Support	<p>Enables the Thunderbolt adapter-peripheral device and USB devices that are connected to the Thunderbolt adapter to be used during BIOS Preboot.</p> <p>By default, the Enable Thunderbolt Boot Support option is disabled.</p> <p>i NOTE: To view this option, enable Advanced Setup mode as described in View Advanced Setup options.</p>
Enable Thunderbolt (and PCIe behind TBT) pre-boot modules	<p>Enables the PCIe devices that are connected through a Thunderbolt adapter to run the PCIe devices UEFI Option ROM (if present) during preboot.</p> <p>By default, the Enable Thunderbolt (and PCIe behind TBT) pre-boot modules option is disabled.</p> <p>i NOTE: To view this option, enable Advanced Setup mode as described in View Advanced Setup options.</p>
Disable USB4 PCIE Tunneling	<p>Disables the USB4 PCIE Tunneling option.</p> <p>By default, the Disable USB4 PCIE Tunneling option is disabled.</p> <p>i NOTE: To view this option, enable Advanced Setup mode as described in View Advanced Setup options.</p>
Video/Power only on Type-C Ports	<p>Enables or disables the Type-C port functionality to video or only power.</p> <p>By default, the Video/Power only on Type-C Ports option is disabled.</p> <p>i NOTE: To view this option, enable Advanced Setup mode as described in View Advanced Setup options.</p>
Type-C Dock Override	<p>Enables or disables to use connected Type-C Dell Dock to provide data stream with external USB ports disabled. When Type-C Dock override is enabled, the Video/Audio/LAN submenu is activated.</p> <p>By default, the Type-C Dock Override option is enabled.</p> <p>i NOTE: To view this option, enable Advanced Setup mode as described in View Advanced Setup options.</p>
Type-C Dock Audio	<p>Enables or disables the usage of audio inputs and outputs from the connected Type-C Dell docking station.</p> <p>By default, the Type-C Dock Audio option is enabled.</p> <p>i NOTE: To view this option, enable Advanced Setup mode as described in View Advanced Setup options.</p>
Type-C Dock LAN	<p>Enables or disables the usage of LAN on the external ports of the connected Type-C Dell docking station.</p> <p>By default, the Type-C Dock LAN option is enabled.</p> <p>i NOTE: To view this option, enable Advanced Setup mode as described in View Advanced Setup options.</p>
Miscellaneous Devices	
Enable Fingerprint Reader Device	<p>Enables or disables the Fingerprint Reader Device option.</p> <p>By default, the Enable Fingerprint Reader Device option is enabled.</p> <p>i NOTE: To view this option, enable Advanced Setup mode as described in View Advanced Setup options.</p>
Unobtrusive Mode	<p>Enables or disables the unobtrusive mode. When enabled, all system LEDs, LCD panel backlight and audio devices of the computer are turned off.</p> <p>By default, the Unobtrusive Mode option is disabled.</p>

Table 44. System Setup options—Integrated Devices menu (continued)

Integrated Devices	
	<p>i NOTE: On computers with collaboration touchpad, the Collaboration Touchpad is disabled when the Unobtrusive Mode option is enabled.</p> <p>i NOTE: To view this option, enable Advanced Setup mode as described in View Advanced Setup options.</p>

Table 45. System Setup options—Storage menu

Storage	
SATA/NVMe Operation	
SATA/NVMe Operation	Sets the operating mode of the integrated SATA hard drive controller. By default, the Raid On option is selected.
Storage Interface	
M.2 PCIe SSD-1	Displays the onboard device interface present in the platform for control.
M.2 PCIe SSD-2	Displays the onboard device interface present in the platform for control.
Smart Reporting	
Enable Smart Reporting	Enables or disables the Smart reporting option. By default, the Smart Reporting option is disabled. <p>i NOTE: To view this option, enable Advanced Setup mode as described in View Advanced Setup options.</p>
Drive Information	
Enable MediaCard	
Secure Digital (SD) Card	Enables or disables the SD card. By default, the Secure Digital (SD) Card option is enabled. <p>i NOTE: To view this option, enable Advanced Setup mode as described in View Advanced Setup options.</p>
Secure Digital (SD) Card Read-Only Mode	Enables or disables the SD card read-only mode. <p>i NOTE: To view this option, enable Advanced Setup mode as described in View Advanced Setup options.</p> <p>By default, the Secure Digital (SD) Card Read-Only Mode option is disabled.</p>

Table 46. System Setup options—Display menu

Display	
Display Brightness	
Brightness on battery power	Enables to set the screen brightness when the computer is running on battery power. By default, the screen brightness is set to 50 when the computer is running on battery power. <p>i NOTE: To view this option, enable Advanced Setup mode as described in View Advanced Setup options.</p>
Brightness on AC power	Enables to set the screen brightness when the computer is running on AC power. By default, the screen brightness is set to 100 when the computer is running on AC power.

Table 46. System Setup options—Display menu (continued)





Display	
	<p> NOTE: To view this option, enable Advanced Setup mode as described in View Advanced Setup options.</p>
Full Screen Logo	<p>Enables or disables the computer to display full screen logo, if the image matches screen resolution.</p> <p>By default, the Full Screen Logo option is disabled.</p> <p> NOTE: To view this option, enable Advanced Setup mode as described in View Advanced Setup options.</p>
Touchscreen	<p>Enables or disables the touch screen option.</p> <p>By default, the Touchscreen option is enabled.</p> <p> NOTE: Only available on computers with touch screen displays.</p> <p> NOTE: To view this option, enable Advanced Setup mode as described in View Advanced Setup options.</p>

Table 47. System Setup options—Connection menu



Connection	
Network Controller Configuration	
Integrated NIC	<p>Enables or disables the network controller.</p> <p>By default, the Enabled with PXE option is selected.</p>
Wireless Device Enable	
WWAN/GPS	<p>Enables or disables the internal WWAN device.</p> <p>By default, the WWAN/GPS option is enabled.</p>
WLAN	<p>Enables or disables the internal WLAN device.</p> <p>By default, the WLAN option is enabled.</p>
Bluetooth	<p>Enables or disables the internal Bluetooth device.</p> <p>By default, the Bluetooth option is enabled.</p>
Contactless Smartcard/NFC	<p>Enables or disables the smartcard device.</p> <p>By default, the Contactless Smartcard/NFC option is enabled.</p> <p> NOTE: To view this option, enable Advanced Setup mode as described in View Advanced Setup options.</p>
Enable UEFI Network Stack	<p>Enables or disables the UEFI Network Stack and controls the onboard LAN Controller.</p> <p>By default, the Auto Enabled option is selected.</p> <p> NOTE: To view this option, enable Advanced Setup mode as described in View Advanced Setup options.</p>
Wireless Radio Control	
Control WLAN Radio	<p>Enables to sense the connection of the computer to a wired network and then disables the selected WLAN radio. Upon disconnection from the wired network, the selected wireless radios are reenabled.</p> <p>By default, the Control WLAN Radio option is disabled.</p>

Table 47. System Setup options—Connection menu (continued)

Connection	
	<p>i NOTE: To view this option, enable Advanced Setup mode as described in View Advanced Setup options.</p>
Control WWAN Radio	<p>Enables to sense the connection of the computer to a wired network and then disables the selected WWAN radios.</p> <p>By default, the Control WWAN Radio option is disabled.</p> <p>i NOTE: To view this option, enable Advanced Setup mode as described in View Advanced Setup options.</p>
HTTP(s) Boot	
HTTP(s) Boot	<p>When enabled, supports HTTP(s) boot on the client BIOS, which offers wired or wireless and HTTP/HTTPS connection options.</p> <p>i NOTE: To view this option, enable Advanced Setup mode as described in View Advanced Setup options.</p>
HTTP(s) Boot Modes	<p>In Auto Mode, the boot URL is obtained from the DHCP response; the boot URL specifies the HTTP Boot Server and location of the Network Boot Program (NBP) file. In Manual mode, the user enters the URL in the text box, which must start with <code>http://</code> or <code>https://</code> and end with the NBP file name.</p> <p>By default, Auto Mode is selected.</p> <p>i NOTE: To view this option, enable Advanced Setup mode as described in View Advanced Setup options.</p>
Boot URL	
Certificate	<p>Upload or delete the certificate.</p> <p>i NOTE: To view this option, enable Advanced Setup mode as described in View Advanced Setup options.</p>

Table 48. System Setup options—Power menu

Power	
Battery Configuration	
Battery Configuration	<p>Enables or disables the computer to run on battery during peak power usage hours. Use the table Custom Charge Start and Custom Charge Stop, to prevent AC power usage between certain times of each day.</p> <p>By default, the Adaptive option is selected. Battery settings are adaptively optimized based on your typical battery usage pattern.</p>
Custom Charge Start	<p>Enables you to set the Custom Charge Start value.</p> <p>Default value: 50</p>
Custom Charge Stop	<p>Enables you to set the Custom Charge Stop value.</p> <p>Default value: 90</p>
Advanced Configuration	
Enable Advanced Battery Charge Configuration	<p>Enables Advanced Battery Charge Configuration from the beginning of the day to a specified work period. When enabled, Advanced Battery Charged maximizes battery health while still supporting heavy use during the work day.</p> <p>By default, the Enable Advanced Battery Charge Configuration option is disabled.</p> <p>i NOTE: To view this option, enable Advanced Setup mode as described in View Advanced Setup options.</p>

Table 48. System Setup options—Power menu (continued)

Power	
Peak Shift	
Enable Peak Shift	<p>Enables or disables the computer to run on battery during peak power usage hours.</p> <p>By default, the Enable Peak Shift option is disabled.</p> <p>NOTE: To view this option, enable Advanced Setup mode as described in View Advanced Setup options.</p>
USB PowerShare	
Enable USB PowerShare	<p>Enables or disables the USB PowerShare on the computer.</p> <p>By default, the USB Powershare option is disabled.</p>
Thermal Management	
	<p>Enables or disables cooling of the fan and manages the processor heat to adjust the system performance, noise, and temperature.</p> <p>By default, the Optimized option is selected. Standard settings for balanced performance, noise, and temperature.</p>
USB Wake Support	
Wake on Dell USB-C Dock	<p>When enabled, connecting a Dell USB-C Dock wakes the computer from Standby, Hibernate, and Power Off.</p> <p>By default, the Wake on Dell USB-C Dock option is enabled.</p> <p>NOTE: To view this option, enable Advanced Setup mode as described in View Advanced Setup options.</p>
Block Sleep	
	<p>Enables or disables the computer from entering Sleep (S3) mode in the operating system.</p> <p>By default, the Block Sleep option is disabled.</p> <p>NOTE: When enabled, the computer does not go to Sleep, Intel Rapid Start is disabled automatically, and the operating system power option is blank if it was set to Sleep.</p> <p>NOTE: To view this option, enable Advanced Setup mode as described in View Advanced Setup options.</p>
Lid Switch	
Enable Lid Switch	<p>Enables or disables the Lid Switch.</p> <p>By default, the Enable Lid Switch option is enabled.</p>
Intel Speed Shift Technology	
	<p>Enables or disables the Intel Speed Shift Technology support. When enabled, the operating system selects the appropriate processor performance automatically.</p> <p>By default, the Intel Speed Shift Technology option is enabled.</p> <p>NOTE: To view this option, enable Service options as described in View Service options.</p>

Table 49. System Setup options—Security menu

Security	
TPM 2.0 Security	<p>Trusted Platform Module (TPM) is a security device that stores computer-generated keys for encryption and features such as BitLocker, Virtual Secure Mode, remote Attestation.</p> <p>By default, the TPM 2.0 Security option is enabled.</p>

Table 49. System Setup options—Security menu (continued)

Security	
	<p>For additional security, Dell Technologies recommends keeping the Trusted Platform Module (TPM) enabled to allow these security technologies to fully function.</p>
TPM 2.0 Security On	<p>Enables or disables the TPM.</p> <p>By default, the TPM 2.0 Security On option is enabled.</p> <p>For additional security, Dell Technologies recommends keeping TPM enabled to allow these security technologies to fully function.</p> <p>NOTE: To view this option, enable Advanced Setup mode as described in View Advanced Setup options.</p>
Attestation Enable	<p>The Attestation Enable option controls the endorsement hierarchy of TPM. Disabling the Attestation Enable option prevents TPM from being used to digitally sign certificates.</p> <p>By default, the Attestation Enable option is enabled.</p> <p>For additional security, Dell Technologies recommends keeping the Attestation Enable option enabled.</p> <p>NOTE: When disabled, this feature may cause compatibility issues or loss of functionality in some operating systems.</p> <p>NOTE: To view this option, enable Advanced Setup mode as described in View Advanced Setup options.</p>
Key Storage Enable	<p>The Key Storage Enable option controls the storage hierarchy of TPM, which is used to store digital keys. Disabling the Key Storage Enable option restricts the ability of TPM to store owner's data.</p> <p>By default, the Key Storage Enable option is enabled.</p> <p>For additional security, Dell Technologies recommends keeping the Key Storage Enable option enabled.</p> <p>NOTE: When disabled, this feature may cause compatibility issues or loss of functionality in some operating systems.</p> <p>NOTE: To view this option, enable Service options as described in View Service options.</p>
SHA-256	<p>Allows you to control the usage of SHA-256 by TPM. When enabled, the BIOS and TPM use the SHA-256 hash algorithm to extend measurements into the TPM PCRs during BIOS boot. When disabled, the BIOS and TPM use the SHA-1 hash algorithm to extend measurements into the TPM PCRs during BIOS boot.</p> <p>By default, the SHA-256 option is enabled.</p> <p>For additional security, Dell Technologies recommends keeping the SHA-256 option enabled.</p> <p>NOTE: To view this option, enable Service options as described in View Service options.</p>
Clear	<p>When enabled, the Clear option clears information that is stored in the TPM after exiting the system's BIOS. This option returns to the disabled state when the computer restarts.</p> <p>By default, the Clear option is disabled.</p> <p>Dell Technologies recommends enabling the Clear option only when TPM data is required to be cleared.</p> <p>NOTE: To view this option, enable Advanced Setup mode as described in View Advanced Setup options.</p>

Table 49. System Setup options—Security menu (continued)





Security	
Physical Presence Interface (PPI) Bypass for Clear Command	<p>The PPI Bypass for Clear Command option allows the operating system to manage certain aspects of PTT. When enabled, you are not prompted to confirm changes to the PTT configuration.</p> <p>By default, the PPI Bypass for Clear Command option is disabled.</p> <p>For additional security, Dell Technologies recommends keeping the PPI Bypass for Clear Command option disabled.</p>
Intel Total Memory Encryption	
Multi-Key Total Memory Encryption (Up to 16 keys)	<p>Enables or disables the processor’s memory encryption feature.</p> <p>By default, the Intel Total Memory Encryption option is disabled.</p> <p> NOTE: To view this option, enable Advanced Setup mode as described in View Advanced Setup options.</p>
Chassis Intrusion	
Chassis Intrusion	<p>Enables or disables the detection of chassis intrusion events. This feature notifies the user when the base cover has been removed from the computer.</p> <p>When set to Enabled, a notification is displayed on the next boot and the event is logged in the BIOS Events log.</p> <p>When set to Disabled, no notification is displayed and no event is logged in the BIOS Events log.</p> <p>When set to On-Silent, the event is logged in the BIOS Events log, but no notification is displayed.</p> <p>By default, the Chassis Intrusion Detection option is disabled.</p> <p>For additional security, Dell Technologies recommends keeping the Chassis Intrusion option enabled.</p> <p> NOTE: To view this option, enable Advanced Setup mode as described in View Advanced Setup options.</p>
Block Boot Until Cleared	<p>The Block Boot Until Clear option is enabled when Chassis Intrusion is enabled. When enabled, the computer does not boot until the chassis intrusion is cleared.</p> <p> NOTE: To view this option, enable Advanced Setup mode as described in View Advanced Setup options.</p>
Clear Intrusion Warning	<p>The Clear Intrusion Warning option appears only after chassis intrusion is enabled and is tripped.</p> <p>By default, the Clear Intrusion Warning option is disabled.</p>
SMM Security Mitigation	
	<p>Enables or disables additional UEFI SMM Security Mitigation protections. This option uses the Windows SMM Security Mitigations Table (WSMT) to confirm to the operating system that security best practices have been implemented by the UEFI firmware.</p> <p>By default, the SMM Security Mitigation option is enabled.</p> <p>For additional security, Dell Technologies recommends keeping the SMM Security Mitigation option enabled unless you have a specific application which is not compatible.</p> <p> NOTE: This feature may cause compatibility issues or loss of functionality with some legacy tools and applications.</p> <p> NOTE: To view this option, enable Service options as described in View Service options.</p>
Data Wipe on Next Boot	

Table 49. System Setup options—Security menu (continued)







<p>Security</p>	<p>Data Wipe is a secure wipe operation that deletes information from a storage device.</p> <p> CAUTION: The Secure Data Wipe operation erases information in a way that it cannot be reconstructed.</p> <p>Commands such as delete and format in the operating system may remove files from showing up in the file system, however they can be reconstructed through forensic means as they are still represented on the physical media. Data Wipe prevents this reconstruction and is not recoverable.</p> <p>When enabled, the BIOS will queue up a data wipe cycle for storage devices that are connected to the motherboard on the next reboot.</p> <p>By default, the Start Data Wipe option is disabled.</p> <p> NOTE: To view this option, enable Advanced Setup mode as described in View Advanced Setup options.</p>
<p>Absolute</p>	<p>Absolute Software provides various cyber security solutions, some requiring software preloaded on Dell computers and integrated into the BIOS. To use these features, you must enable the Absolute BIOS setting and contact Absolute for configuration and activation.</p> <p>By default, the Absolute option is enabled.</p> <p>For additional security, Dell Technologies recommends keeping the Absolute option enabled.</p> <p> WARNING: The Permanently Disabled option can only be selected once. When Permanently Disabled is selected, Absolute Persistence cannot be reenabled. No further changes to the Enable/Disable states are allowed.</p> <p> NOTE: The Enable/Disable options are unavailable while the computer is in the activated state.</p> <p> NOTE: When the Absolute features are activated, the Absolute integration cannot be disabled from the BIOS Setup screen.</p>
<p>UEFI Boot Path Security</p>	<p>Enables or disables the computer to prompt the user to enter the Administrator password (if set) when booting to a UEFI boot path device from the F12 boot menu.</p> <p>By default, the Always Except Internal HDD option is enabled.</p> <p> NOTE: To view this option, enable Advanced Setup mode as described in View Advanced Setup options.</p>
<p>Firmware Device Tamper Detection</p>	<p>Allows you to control the firmware device tamper detection feature. This feature notifies the user when the firmware device is tampered. When enabled, a screen warning message is displayed on the computer and a tamper detection event is logged in the BIOS Events log. The computer fails to reboot until the event is cleared.</p> <p>By default, the Firmware Device Tamper Detection option is enabled.</p> <p>For additional security, Dell Technologies recommends keeping the Firmware Device Tamper Detection option enabled.</p> <p> NOTE: To view this option, enable Advanced Setup mode as described in View Advanced Setup options.</p>
<p>Clear Firmware Device Tamper Detection</p>	<p>Allows you to clear the events that are logged when tampering of firmware device is detected.</p> <p>By default, the Clear Firmware Device Tamper Detection option is disabled.</p>

Table 49. System Setup options—Security menu (continued)

Security	
 NOTE: To view this option, enable Advanced Setup mode as described in View Advanced Setup options .	

Table 50. System Setup options—Passwords menu

Passwords	
Administrator Password	<p>The Administrator Password prevents unauthorized access to the BIOS Setup options. Once the administrator password is set, the BIOS Setup options can only be modified after providing the correct password.</p> <p>The following rules and dependencies apply to the Administrator Password -</p> <ul style="list-style-type: none"> • The administrator password cannot be set if system and/or internal hard drive passwords are previously set. • The administrator password can be used in place of the system and/or internal hard drive passwords. • When set, the administrator password must be provided during a firmware update. • Clearing the administrator password also clears the system password (if set). <p>Dell Technologies recommends using an administrator password to prevent unauthorized changes to BIOS Setup options.</p>
System Password	<p>The System Password prevents the computer from booting to an operating system without entering the correct password.</p> <p>The following rules and dependencies apply when the System Password is used -</p> <ul style="list-style-type: none"> • The computer shuts down when idle for approximately 10 minutes at the system password prompt. • The computer shuts down after three incorrect attempts to enter the system password. • The computer shuts down when the Esc key is pressed at the System Password prompt. • The system password is not prompted when the computer resumes from standby mode. <p>Dell Technologies recommends using the system password in situations where it is likely that a computer may be lost or stolen.</p>
Hard Drive Password  NOTE: On some computers, the M.2 PCIe SSD-0 Password option is shown.	<p>The hard drive password can be set to prevent unauthorized access of the data stored on the solid-state drive. The computer prompts for the hard drive password during boot in order to unlock the drive. A password-secured hard drive stays locked even when removed from the computer or placed into another computer. It prevents an attacker from accessing data on the drive without authorization.</p> <p>The following rules and dependencies apply when the Hard Drive Password or M.2 PCIe SSD-0 Password option is used.</p> <ul style="list-style-type: none"> • The hard drive password option cannot be accessed when the hard drive is disabled in the BIOS Setup. • The computer shuts down when idle for approximately 10 minutes at the hard drive password prompt. • The computer shuts down after three incorrect attempts to enter the hard drive password and treats the hard drive as not available. • The hard drive does not accept password unlock attempts after five incorrect attempts to enter the hard drive password from the BIOS Setup. The hard drive password must be reset for the new password unlock attempts. • The computer treats the hard drive as not available when the Esc key is pressed at the hard drive password prompt. • The hard drive password is not prompted when the computer resumes from standby mode. When the hard drive is unlocked by the user before the

Table 50. System Setup options—Passwords menu (continued)

Passwords	
	<p>computer goes into standby mode, it remains unlocked after the computer resumes from standby mode.</p> <ul style="list-style-type: none"> • If the system and hard drive passwords are set to the same value, the hard drive unlocks after the correct system password is entered. <p>Dell Technologies recommends using a hard drive password to protect unauthorized data access.</p>
Password Configuration	<p>The Password configuration page includes several options for changing the requirements of BIOS passwords. You can modify the minimum and maximum length of the passwords as well as require passwords to contain certain character classes (upper case, lower case, digit, special character).</p> <p>When the Lower Case Letter option is enabled, the password requires at least one lower case letter.</p> <p>When the Upper Case Letter option is enabled, the password requires at least one upper case letter.</p> <p>When the Digit option is enabled, the password requires at least one numeric digit.</p> <p>When the Special Character option is enabled, the password requires at least one special character from the set: !"#%&'()*+,-./:;<=>?@[\\]^_`{ }~.</p> <p>When setting Minimum Characters for password length, Dell Technologies recommends setting the minimum password length to at least eight characters.</p> <p>NOTE: To view this option, enable Advanced Setup mode as described in View Advanced Setup options.</p>
Password Bypass	<p>The Password Bypass option allows the computer to reboot from the operating system without entering the system or hard drive password. If the computer has already booted to the operating system, it is presumed that the user has already entered the correct system or hard drive password.</p> <p>NOTE: This option does not remove the requirement to enter the password after shutting down.</p> <p>By default, the Password Bypass option is disabled.</p> <p>For additional security, Dell Technologies recommends keeping the Password Bypass option enabled.</p> <p>NOTE: To view this option, enable Advanced Setup mode as described in View Advanced Setup options.</p>
Password Changes	
Allow Non-Admin Password Changes	<p>The Allow Non-Admin Password Changes option in BIOS Setup allows an end user to set or change the system or hard drive passwords without entering the administrator password. This gives an administrator control over the BIOS settings but enables an end user to provide their own password.</p> <p>By default, the Allow Non-Admin Password Changes option is enabled.</p> <p>For additional security, Dell Technologies recommends keeping the Allow Non-Admin Password Changes option disabled.</p> <p>NOTE: To view this option, enable Advanced Setup mode as described in View Advanced Setup options.</p>
Non-Admin Setup Changes	<p>The Non-Admin Setup Changes option allows an end user to configure the wireless devices without requiring the administrator password.</p> <p>By default, the Non-Admin Setup Changes option is disabled.</p> <p>For additional security, Dell Technologies recommends keeping the Non-Admin Setup Changes option disabled.</p>

Table 50. System Setup options—Passwords menu (continued)

Passwords	
	<p>i NOTE: To view this option, enable Advanced Setup mode as described in View Advanced Setup options.</p>
Enable Admin Setup Lockout	<p>The Admin Setup Lockout option prevents an end user from even viewing the BIOS Setup configuration without first entering the administrator password (if set).</p> <p>By default, the Enable Admin Setup Lockout option is disabled.</p> <p>For additional security, Dell Technologies recommends keeping the Admin Setup Lockout option disabled.</p> <p>i NOTE: To view this option, enable Advanced Setup mode as described in View Advanced Setup options.</p>
Enable Master Password Lockout	<p>The Master Password Lockout option allows you to disable the Recovery Password feature. If the system, administrator, or hard drive password is forgotten, the computer becomes unusable.</p> <p>i NOTE: When the owner password is set, the Master Password Lockout option is not available.</p> <p>i NOTE: When an internal hard drive password is set, it must first be cleared before Master Password Lockout can be changed.</p> <p>By default, the Enable Master Password Lockout option is disabled.</p> <p>Dell Technologies does not recommend enabling the Master Password Lockout unless you have implemented your own password recovery system.</p> <p>i NOTE: To view this option, enable Advanced Setup mode as described in View Advanced Setup options.</p>
Enable Allow Non-Admin PSID Revert	<p>The Allow Non-Admin PSID Revert option allows a user to clear the hard drive password without entering the BIOS Admin Password. When an Admin Password is set, the ability to enter the PSID is protected by requiring authentication with the Admin Password. If this option is enabled, any user can clear the drive without entering the Admin Password.</p> <p>By default, the Enable Allow Non-Admin PSID Revert option is disabled.</p> <p>i NOTE: To view this option, enable Advanced Setup mode as described in View Advanced Setup options.</p>

Table 51. System Setup options—Update, Recovery menu

Update, Recovery	
UEFI Capsule Firmware Updates	
Enable UEFI Capsule Firmware Updates	<p>Enables or disables BIOS updates through UEFI capsule update packages.</p> <p>i NOTE: Disabling this option blocks the BIOS updates from services such as Microsoft Windows Update and Linux Vendor Firmware Service (LVFS).</p> <p>By default, the Enable UEFI Capsule Firmware Updates option is enabled.</p> <p>i NOTE: To view this option, enable Advanced Setup mode as described in View Advanced Setup options.</p>
BIOS Recovery from Hard Drive	<p>Enables or disables the user to recover from certain corrupted BIOS conditions from a recovery file on the user primary hard drive or an external USB drive.</p> <p>By default, the BIOS Recovery from Hard Drive option is enabled.</p> <p>i NOTE: BIOS Recovery from Hard Drive is not available for self-encrypting drives (SED).</p>

Table 51. System Setup options—Update, Recovery menu (continued)

Update, Recovery	
	<p>i NOTE: BIOS recovery is designed to fix the main BIOS block and cannot work if the Boot Block is damaged. In addition, this feature cannot work in the event of EC corruption, ME corruption, or a hardware issue. The recovery image must exist on an unencrypted partition on the drive.</p> <p>i NOTE: To view this option, enable Advanced Setup mode as described in View Advanced Setup options.</p>
BIOS Downgrade	
Allow BIOS Downgrade	<p>Allows downgrading of the system firmware to previous revisions.</p> <p>By default, the Allow BIOS Downgrade option is enabled.</p>
SupportAssist OS Recovery	
	<p>Enables or disables the boot flow for SupportAssist OS Recovery tool if certain system errors occur.</p> <p>By default, the SupportAssist OS Recovery option is enabled.</p>
BIOSConnect	
	<p>Enables or disables cloud service operating system recovery if the main operating system fails to boot with the number of failures equal to or greater than the value specified by the Auto operating system Recovery Threshold setup option and local service operating system does not boot or is not installed.</p> <p>By default, the BIOSConnect option is enabled.</p>
Dell Auto OS Recovery Threshold	
	<p>Allows the control of the automatic boot flow for the SupportAssist System Resolution Console and the Dell operating system Recovery Tool.</p> <p>By default, the Dell Auto OS Recovery Threshold value is set to 2.</p> <p>i NOTE: To view this option, enable Advanced Setup mode as described in View Advanced Setup options.</p>

Table 52. System Setup options—System Management menu

System Management	
Service Tag	Displays the Service Tag of the computer.
Asset Tag	<p>Creates a computer Asset Tag that an IT administrator can use to uniquely identify a particular computer.</p> <p>i NOTE: Once set in the BIOS, the Asset Tag cannot be changed.</p>
AC Behavior	
Wake on AC	<p>Enables or disables the computer to turn on and go to boot when AC power is supplied to the computer.</p> <p>By default, the Wake on AC option is disabled.</p> <p>i NOTE: To view this option, enable Advanced Setup mode as described in View Advanced Setup options.</p>
Wake on LAN	<p>Enables or disables the computer to turn on by a special LAN signal.</p> <p>By default, the Wake on LAN option is disabled.</p> <p>i NOTE: To view this option, enable Advanced Setup mode as described in View Advanced Setup options.</p>
Auto On Time	<p>Enable to set the computer to turn on automatically every day or on a preselected date and time. This option can be configured only if the Auto On Time is set to Everyday, Weekdays, or Selected Days.</p> <p>By default, the Auto On Time option is disabled.</p>

Table 52. System Setup options—System Management menu (continued)





System Management	
	<p> NOTE: To view this option, enable Advanced Setup mode as described in View Advanced Setup options.</p>
Intel AMT capability	<p>Configure Intel Active Management Technology (AMT) options, which can be enabled, disabled, or restricted.</p> <p> NOTE: To view this option, enable Advanced Setup mode as described in View Advanced Setup options.</p>
First Power On Date	
Set Ownership Date	<p>Enables you to set the ownership date.</p> <p>By default, the Set Ownership Date option is disabled.</p>
Diagnostics OS agent requests	<p>Enable or disable the option for applications running in the operating system to run with preboot diagnostics on subsequent boots.</p> <p> NOTE: To view this option, enable Advanced Setup mode as described in View Advanced Setup options.</p>
Power-On-Self-Test Automatic Recovery	<p>Enable or disable the automatic recovery of the computer from no power or no-POST failure by applying mitigation steps.</p> <p>By default, the Power-On-Self-Test Automatic Recovery option is enabled.</p> <p> NOTE: To view this option, enable Advanced Setup mode as described in View Advanced Setup options.</p>

Table 53. System Setup options—Keyboard menu

Keyboard	
Numlock Enable	
Enable Numlock	<p>Enables or disables the Numlock.</p> <p>By default, the Numlock option is enabled.</p>
Fn Lock Options	
Fn Lock Mode	<p>Enables or disables the Fn Lock option.</p> <p>By default, the Fn Lock option is enabled.</p>
Lock Mode	<p>By default, the Lock Mode option is enabled. With this option, the F1-F12 keys scan the code for their secondary functions.</p>
Keyboard Illumination	
	<p>Configures the operating mode of the keyboard illumination feature.</p> <p>By default, the Dim option is selected. Enables the keyboard illumination feature at 100% brightness level.</p>
Keyboard Backlight Timeout on AC	
	<p>Sets the timeout value for the keyboard backlight when an AC adapter is connected to the computer.</p> <p>By default, the 10 seconds option is selected.</p> <p> NOTE: To view this option, enable Advanced Setup mode as described in View Advanced Setup options.</p>
Keyboard Backlight Timeout on Battery	
	<p>Sets the timeout value for the keyboard backlight when the computer is running only on the battery power. The keyboard backlight timeout value is only effective when the backlight is enabled.</p> <p>By default, the 10 seconds option is selected.</p>

Table 53. System Setup options—Keyboard menu (continued)

Keyboard	
	<p>i NOTE: To view this option, enable Advanced Setup mode as described in View Advanced Setup options.</p>
Device Configuration HotKey Access	<p>Allows you to control whether you can access device configuration screens through hotkeys during system startup.</p> <p>By default, the Device Configuration HotKey Access option is enabled.</p> <p>i NOTE: This setting controls only the Intel RAID (CTRL+I), MEBX (CTRL+P), and LSI RAID (CTRL+C) Option ROMs. Other preboot Option ROMs, which support entry using a key sequence, are not affected by this setting.</p> <p>i NOTE: To view this option, enable Advanced Setup mode as described in View Advanced Setup options.</p>

Table 54. System Setup options—Pre-boot Behavior menu

Pre-boot Behavior	
Adapter Warnings	
Enable Adapter Warnings	<p>Enables the warning messages during boot when the adapters with less power capacity are detected.</p> <p>By default, the Enable Adapter Warnings option is enabled.</p> <p>i NOTE: To view this option, enable Advanced Setup mode as described in View Advanced Setup options.</p>
Warnings and Errors	<p>Enables or disables the action to be taken when a warning or error is encountered.</p> <p>By default, the Prompt on Warnings and Errors option is selected. Stop, prompt, and wait for user input when warnings or errors are detected.</p> <p>i NOTE: Errors deemed critical to the operation of the computer hardware stop the functioning of the computer.</p> <p>i NOTE: To view this option, enable Advanced Setup mode as described in View Advanced Setup options.</p>
Extend BIOS POST Time	<p>Sets the BIOS POST (Power-On Self-Test) load time.</p> <p>By default, the 0 seconds option is selected.</p> <p>i NOTE: To view this option, enable Advanced Setup mode as described in View Advanced Setup options.</p>
MAC Address Pass-Through	<p>Replaces the external NIC MAC address (in a supported dock or dongle) with the selected MAC address from the computer.</p> <p>By default, the System Unique MAC Address option is selected.</p>
Sign of Life	
Early Keyboard Backlight	<p>Enables or disables the Keyboard Backlight Sign of Life.</p> <p>By default, the Early Keyboard Backlight option is enabled.</p> <p>i NOTE: To view this option, enable Advanced Setup mode as described in View Advanced Setup options.</p>

Table 55. System Setup options—Virtualization Support menu

Virtualization Support	
Intel Virtualization Technology	

Table 55. System Setup options—Virtualization Support menu (continued)

Virtualization Support	
Enable Intel Virtualization Technology (VT)	<p>When enabled, the computer can run a Virtual Machine Monitor (VMM).</p> <p>By default, the Enable Intel Virtualization Technology (VT) option is enabled.</p> <p>NOTE: To view this option, enable Advanced Setup mode as described in View Advanced Setup options.</p>
VT for Direct I/O	
Enable Intel VT for Direct I/O	<p>When enabled, the computer can perform Virtualization Technology for Direct I/O (VT-d). VT-d is an Intel method that provides virtualization for memory map I/O.</p> <p>By default, the Enable Intel VT for Direct I/O option is enabled.</p> <p>NOTE: To view this option, enable Advanced Setup mode as described in View Advanced Setup options.</p>
Intel Trusted Execution Technology (TXT)	<p>Specifies whether a measured Virtual Machine Monitor (MVMM) can use the additional hardware capabilities provided by Intel Trusted Execution Technology. The following must be enabled in order to enable Intel TXT -</p> <ul style="list-style-type: none"> • Trusted Platform Module (TPM) • Intel Hyper-Threading • All CPU cores (Multi-Core Support) • Intel Virtualization Technology • Intel VT for Direct I/O <p>By default, the Intel Trusted Execution Technology (TXT) option is disabled.</p> <p>NOTE: To view this option, enable Advanced Setup mode as described in View Advanced Setup options.</p>
DMA Protection	
Enable Pre-Boot DMA Support	<p>Allows you to control the Pre-Boot DMA protection for both internal and external ports. This option does not directly enable DMA protection in the operating system.</p> <p>NOTE: This option is not available when the virtualization setting for IOMMU is disabled (VT-d/AMD Vi).</p> <p>By default, the Enable Pre-Boot DMA Support option is enabled.</p> <p>For additional security, Dell Technologies recommends keeping the Enable Pre-Boot DMA Support option enabled.</p> <p>NOTE: This option is provided only for compatibility purposes, since some older hardware is not DMA capable.</p> <p>NOTE: To view this option, enable Advanced Setup mode as described in View Advanced Setup options.</p>
Enable OS Kernel DMA Support	<p>Allows you to control the Kernel DMA protection for both internal and external ports. This option does not directly enable DMA protection in the operating system. For operating systems that support DMA protection, this setting indicates to the operating system that the BIOS supports the feature.</p> <p>NOTE: This option is not available when the virtualization setting for IOMMU is disabled (VT-d/AMD Vi).</p> <p>By default, the Enable OS Kernel DMA Support option is enabled.</p> <p>NOTE: This option is provided only for compatibility purposes, since some older hardware is not DMA capable.</p> <p>NOTE: To view this option, enable Advanced Setup mode as described in View Advanced Setup options.</p>

Table 55. System Setup options—Virtualization Support menu (continued)

Virtualization Support	
Internal Port DMA Compatibility Mode	By default, the Internal Port DMA Compatibility Mode option is disabled.

Table 56. System Setup options—Performance menu

Performance	
Multi-Core Support	
Multiple Atom Cores	<p>Change the number of Atom cores available to the operating system. The default value is set to the maximum number of cores.</p> <p>By default, the All Cores option is selected.</p> <p>i NOTE: To view this option, enable Advanced Setup mode as described in View Advanced Setup options.</p>
Intel SpeedStep	
Enable Intel SpeedStep Technology	<p>Enables the computer to dynamically adjust processor voltage and core frequency, decreasing average power consumption and heat production.</p> <p>By default, the Enable Intel SpeedStep Technology option is enabled.</p> <p>i NOTE: To view this option, enable Service options as described in View Service options.</p>
C-State Control	
Enable C-State Control	<p>Enables or disables the ability of the CPU to enter and exit low-power state. When disabled, it disables all C-states. When enabled, it enables all C-states that the chipset or platform allows.</p> <p>By default, the Enable C-State Control option is enabled.</p> <p>i NOTE: To view this option, enable Advanced Setup mode as described in View Advanced Setup options.</p>
Enable Afaptive C-States for Discrete Graphics	
Enable Afaptive C-States for Discrete Graphics	<p>Allows the computer to dynamically detect high usage of discrete graphics and adjust the system parameters for higher performance during that time period.</p> <p>By default Enable Afaptive C-States for Discrete Graphics is enabled.</p>
Intel TurboBoost Technology	
Enable Intel Turbo Boost Technology	<p>Enables or disables the Intel TurboBoost mode of the processor. When enabled, the Intel TurboBoost driver increases the performance of the CPU or graphics processor.</p> <p>By default, the Enable Intel TurboBoost Technology option is enabled.</p> <p>i NOTE: To view this option, enable Advanced Setup mode as described in View Advanced Setup options.</p>
Intel HyperThread Technology	
Enable Intel HyperThread Technology	<p>Enables or disables the Intel Hyper-Threading mode of the processor. When enabled, the Intel Hyper-Threading increases the efficiency of the processor resources when multiple threads run on each core.</p> <p>By default, the Intel HyperThread Technology option is enabled.</p> <p>i NOTE: To view this option, enable Advanced Setup mode as described in View Advanced Setup options.</p>
Dynamic Tuning: Machine Learning	

Table 56. System Setup options—Performance menu (continued)

Performance	
Enable Dynamic Tuning: Machine Learning	<p>Enables or disables operating system capability to enhance power tuning capabilities depending on the detected workloads.</p> <p>NOTE: This option is available for development only and is not customer visible.</p> <p>By default, the Enable Dynamic Tuning: Machine Learning option is enabled.</p> <p>NOTE: To view this option, enable Service options as described in View Service options.</p>

Table 57. System Setup options—System Logs menu

System Logs	
BIOS Event Log	
Clear BIOS Event Log	<p>Select the option to keep or clear BIOS events logs.</p> <p>By default, the Keep Log option is selected.</p> <p>NOTE: To view this option, enable Advanced Setup mode as described in View Advanced Setup options.</p>
Thermal Event Log	
Clear Thermal Event Log	<p>Select the option to keep or clear Thermal events logs.</p> <p>By default, the Keep Log option is selected.</p> <p>NOTE: To view this option, enable Advanced Setup mode as described in View Advanced Setup options.</p>
Power Event Log	
Clear Power Event Log	<p>Select the option to keep or clear Power events logs.</p> <p>By default, the Keep Log option is selected.</p> <p>NOTE: To view this option, enable Advanced Setup mode as described in View Advanced Setup options.</p>

Updating the BIOS

Updating the BIOS in Windows

About this task

CAUTION: If BitLocker is not suspended before updating the BIOS, the next time you reboot the computer it will not recognize the BitLocker key. You will then be prompted to enter the recovery key to progress, and the computer will ask for this on each reboot. If the recovery key is not known this can result in data loss or an unnecessary operating system reinstall. For more information about this subject, search in the Knowledge Base Resource at [Dell Support Site](#).

Steps

1. Go to [Dell Support Site](#).
2. Click **Product support**. In the **Search support** box, enter the Service Tag of your computer, and then click **Search**.

NOTE: If you do not have the Service Tag, use the SupportAssist to automatically identify your computer. You can also use the product ID or manually browse for your computer model.

3. Click **Drivers & Downloads**. Expand **Find drivers**.
4. Select the operating system installed on your computer.
5. In the **Category** drop-down list, select **BIOS**.
6. Select the latest version of BIOS, and click **Download** to download the BIOS file for your computer.
7. After the download is complete, browse the folder where you saved the BIOS update file.
8. Double-click the BIOS update file icon and follow the on-screen instructions.

For more information, search in the Knowledge Base Resource at [Dell Support Site](#).

Updating the BIOS in Linux and Ubuntu

To update the system BIOS on a computer that is installed with Linux or Ubuntu, see the knowledge base article [000131486](#) at [Dell Support Site](#).

Updating the BIOS using the USB drive in Windows

About this task

 **CAUTION:** If BitLocker is not suspended before updating the BIOS, the next time you reboot the computer it will not recognize the BitLocker key. You will then be prompted to enter the recovery key to progress, and the computer will ask for this on each reboot. If the recovery key is not known this can result in data loss or an unnecessary operating system reinstall. For more information about this subject, search in the Knowledge Base Resource at [Dell Support Site](#).

Steps

1. Follow the procedure from step 1 to step 6 in [Updating the BIOS in Windows](#) to download the latest BIOS setup program file.
2. Create a bootable USB drive. For more information, search in the Knowledge Base Resource at [Dell Support Site](#).
3. Copy the BIOS setup program file to the bootable USB drive.
4. Connect the bootable USB drive to the computer that needs the BIOS update.
5. Restart the computer and press **F12**.
6. Select the USB drive from the **One Time Boot Menu**.
7. Type the BIOS setup program filename and press **Enter**.
The **BIOS Update Utility** appears.
8. Follow the on-screen instructions to complete the BIOS update.

Updating the BIOS from the One-Time boot menu

Update your computer BIOS using the BIOS XXXX.exe file that is copied to a FAT32 USB drive and booting from the One-Time boot menu.

About this task

 **CAUTION:** If BitLocker is not suspended before updating the BIOS, the next time you reboot the computer it will not recognize the BitLocker key. You will then be prompted to enter the recovery key to progress, and the computer will ask for this on each reboot. If the recovery key is not known this can result in data loss or an unnecessary operating system reinstall. For more information about this subject, search in the Knowledge Base Resource at [Dell Support Site](#).

BIOS Update

You can run the BIOS flash update file from Windows using a bootable USB drive or you can also update the BIOS from the One-Time boot menu on the computer.

You can confirm by booting your computer to the **One Time Boot** Menu to see if BIOS FLASH UPDATE is listed as a boot option. If the option is listed, then the BIOS can be updated using this method.

Updating from the One-Time boot menu

To update your BIOS from the One-Time boot menu, you need the following:

- USB drive formatted to the FAT32 file system (the drive does not have to be bootable)
- BIOS executable file that you downloaded from the Dell Support website and copied to the root of the USB drive
- AC power adapter must be connected to the computer
- Functional computer battery to flash the BIOS

Perform the following steps to perform the BIOS flash update process from the One-Time boot menu:

 **CAUTION:** Do not turn off the computer during the BIOS flash update process. The computer may not boot if you turn off your computer.

Steps

1. Turn off your computer, insert the USB drive where you copied the BIOS flash update file into a USB port of the computer.
2. Turn on the computer and press to access the **One Time Boot** Menu. Select BIOS Update using the mouse or arrow keys then press Enter.
The flash BIOS menu is displayed.
3. Click **Flash from file**.
4. Select the external USB device.
5. Select the file and double-click the flash target file, and then click **Submit**.
6. Click **Update BIOS**. The computer restarts to flash the BIOS.
7. The computer will restart after the BIOS flash update is completed.

System and setup password

Table 58. System and setup password

Password type	Description
System password	Password that you must enter to log in to your system.
Setup password	Password that you must enter to access and make changes to the BIOS settings of your computer.

You can create a system password and a setup password to secure your computer.

 **CAUTION:** The password features provide a basic level of security for the data on your computer.

 **CAUTION:** Anyone can access the data that is stored on your computer, when left unattended.

 **NOTE:** System and setup password feature is disabled.

Assigning a System Setup password

Prerequisites

You can assign a new System or Admin Password only when the status is in **Not Set**.

About this task

To enter BIOS System Setup, press F2 immediately after a power-on or reboot.

Steps

1. In the **System BIOS** or **System Setup** screen, select **Security** and press Enter.
The **Security** screen is displayed.
2. Select **System/Admin Password** and create a password in the **Enter the new password** field.
Use the following guidelines to assign the system password:
 - A password can have up to 32 characters.

- At least one special character: "(! " # \$ % & ' * + , - . / : ; < = > ? @ [\] ^ _ ` { | })"
- Numbers 0 to 9.
- Upper case letters from A to Z.
- Lower case letters from a to z.

3. **Confirm new password** type the system password that you entered earlier in the field and click **OK**.
4. Press Esc and save the changes as prompted by the message.
5. Press Y to save the changes.
The computer restarts.

Deleting or changing an existing system password or setup password

Prerequisites

Ensure that the **Password Status** is Unlocked (in the System Setup) before attempting to delete or change the existing system password and/or setup password. You cannot delete or change an existing system password or setup password if the **Password Status** is Locked.

About this task

To enter the System Setup, press F2 immediately after a power-on or reboot.

Steps

1. In the **System BIOS** or **System Setup** screen, select **System Security** and press Enter.
The **System Security** screen is displayed.
2. In the **System Security** screen, verify that the **Password Status** is Unlocked.
3. Select **System Password**. Update or delete the existing system password, and press Enter or Tab.
4. Select **Setup Password**. Update or delete the existing setup password, and press Enter or Tab.
 -  **NOTE:** If you change the system password and/or setup password, reenter the new password when prompted. If you delete the system password and/or setup password, confirm the deletion when prompted.
5. Press Esc. A message prompts you to save the changes.
6. Press Y to save the changes and exit from **System Setup**.
The computer restarts.

Clearing CMOS settings

About this task

 **CAUTION:** Clearing CMOS settings resets the BIOS settings on your computer.

Steps

1. Remove the [base cover](#).
2. Disconnect the battery cable from the system board.
3. Remove the [coin-cell battery](#).
4. Wait for one minute.
5. Replace the [coin-cell battery](#).
6. Connect the battery cable to the system board.
7. Replace the [base cover](#).

Clearing BIOS (System Setup) and System passwords

About this task

To clear the computer or BIOS passwords, contact Dell technical support as described at [Contact Support](#). For more information, go to [Dell Support Site](#).

 **NOTE:** For information about how to reset Windows or application passwords, see the documentation accompanying Windows or your application.

Troubleshooting

Handling swollen rechargeable Li-ion batteries

Like most laptops, Dell laptops use Lithium-ion batteries. One type of Lithium-ion battery is the rechargeable Li-ion battery. Rechargeable Li-ion batteries have increased in popularity in recent years and have become a standard in the electronics industry due to customer preferences for a slim form factor (especially with newer ultra-thin laptops) and long battery life. Inherent to rechargeable Li-ion battery technology is the potential for swelling of the battery cells.

A swollen battery may impact the performance of the laptop. To prevent possible further damage to the device enclosure or internal components leading to malfunction, discontinue the use of the laptop and discharge it by disconnecting the AC adapter and letting the battery drain.

Swollen batteries should not be used and must be replaced and disposed of properly. We recommend contacting Dell Support for options to replace a swollen battery under the terms of the applicable warranty or service contract, including options for replacement by a Dell authorized service technician.

The guidelines for handling and replacing rechargeable Li-ion batteries are as follows:

- Exercise caution when handling rechargeable Li-ion batteries.
- Discharge the battery before removing it from the computer. To discharge the battery, unplug the AC adapter from the computer and operate the computer only on battery power. The battery is fully discharged when the computer no longer turns on when the power button is pressed.
- Do not crush, drop, mutilate, or penetrate the battery with foreign objects.
- Do not expose the battery to high temperatures, or disassemble battery packs and cells.
- Do not apply pressure to the surface of the battery.
- Do not bend the battery.
- Do not use tools of any type to pry on or against the battery.
- If a battery gets stuck in a device as a result of swelling, do not try to free it as puncturing, bending, or crushing a battery can be dangerous.
- Do not attempt to reassemble a damaged or swollen battery into a laptop.
- Swollen batteries that are covered under warranty should be returned to Dell in an approved shipping container (provided by Dell)—this is to comply with transportation regulations. Swollen batteries that are not covered under warranty should be disposed of at an approved recycling center. Contact Dell Support at [Dell Support Site](#) for assistance and further instructions.
- Using a non-Dell or incompatible battery may increase the risk of fire or explosion. Replace the battery only with a compatible battery purchased from Dell that is designed to work with your Dell computer. Do not use a battery from other computers with your computer. Always purchase genuine batteries from [Dell Site](#) or otherwise directly from Dell.

Rechargeable Li-ion batteries can swell for various reasons such as age, number of charge cycles, or exposure to high heat. For more information about how to improve the performance and lifespan of the laptop battery and to minimize the possibility of occurrence of the issue, search Dell laptop battery in the Knowledge Base Resource at [Dell Support Site](#).

Locating the Service Tag or Express Service Code of your Dell computer

Your Dell computer is uniquely identified with a Service Tag or Express Service Code. To view relevant support resources for your Dell computer, we recommend entering the Service Tag or Express Service Code at [Dell Support Site](#).

For more information about how to find the Service Tag for your computer, see [Instructions on how to find your Service Tag or Serial Number](#).

Dell SupportAssist Pre-boot System Performance Check diagnostics

About this task

SupportAssist diagnostics (also known as system diagnostics) performs a complete check of your hardware. The Dell SupportAssist Pre-boot System Performance Check diagnostics is embedded with the BIOS and launched by the BIOS internally. The embedded system diagnostics provides options for particular devices or device groups allowing you to:

- Run tests automatically or in an interactive mode.
- Repeat the tests.
- Display or save test results.
- Run thorough tests to introduce additional test options to provide extra information about one or more failed devices.
- View status messages that inform you the tests are completed successfully.
- View error messages that inform you of problems encountered during testing.

 **NOTE:** Some tests for specific devices require user interaction. Always ensure that you are present at the computer when the diagnostic tests are performed.

For more information, see the knowledge base article [000180971](#).

Running the SupportAssist Pre-Boot System Performance Check

Steps

1. Turn on your computer.
2. As the computer boots, press the F12 key as the Dell logo appears.
3. On the boot menu screen, select the **Diagnostics** option.
4. Click the arrow at the bottom left corner.
Diagnostics page is displayed.
5. Click the arrow in the lower-right corner to go to the page listing.
The items that are detected are listed.
6. To run a diagnostic test on a specific device, press Esc and click **Yes** to stop the diagnostic test.
7. Select the device from the left pane and click **Run Tests**.
8. If there are any issues, error codes are displayed.
Note the error code and validation number and contact Dell.

Built-in self-test (BIST)

M-BIST

M-BIST (Built In Self-Test) is the system board built-in self-test diagnostics tool that improves the diagnostics accuracy of system board Embedded Controller (EC) failures.

 **NOTE:** M-BIST can be manually initiated before Power On Self-Test (POST).

How to run M-BIST

 **NOTE:** Before initiating M-BIST, ensure that the computer is in a power-off state.

1. Press and hold both the **M** key on the keyboard and the power button to initiate M-BIST.
2. The battery indicator LED may exhibit two states:
 - a. OFF: No fault was detected with the system board.
 - b. AMBER: Amber indicates a problem with the system board.
3. If there is a failure with the system board, the battery status LED flashes one of the following error codes for 30 seconds:

Table 59. LED error codes

Blinking Pattern		Possible Problem
Amber	White	
2	1	CPU Failure
2	8	LCD Power Rail Failure
1	1	TPM Detection Failure
2	4	Memory/RAM failure

4. If there is no failure with the system board, the LCD cycles through the solid color screens that are described in the LCD-BIST section for 30 seconds and then turn off.

LCD Power rail test (L-BIST)

L-BIST is an enhancement to the single LED error code diagnostics and is automatically initiated during POST. L-BIST will check the LCD power rail. If there is no power being supplied to the LCD (that is if the L-BIST circuit fails), the battery status LED flashes either an error code [2,8] or an error code [2,7].

NOTE: If L-BIST fails, LCD-BIST cannot function as no power will be supplied to the LCD.

How to invoke the L-BIST

1. Turn on your computer computer.
2. If the computer does not start up normally, look at the battery status LED:
 - If the battery status LED flashes an error code [2,7], the display cable may not be connected properly.
 - If the battery status LED flashes an error code [2,8], there is a failure on the LCD power rail of the system board, hence there is no power that is supplied to the LCD.
3. For cases, when a [2,7] error code is shown, check to see if the display cable is properly connected.
4. For cases when a [2,8] error code is shown, replace the system board.

LCD Built-in Self-Test (BIST)

Dell laptops have a built-in diagnostic tool that helps you determine if the screen abnormality you are experiencing is an inherent problem with the LCD (screen) of the Dell laptop or with the video card (GPU) and computer settings.

When you notice screen abnormalities like flickering, distortion, clarity issues, fuzzy or blurry image, horizontal or vertical lines, color fade and so on, it is always a good practice to isolate the LCD (screen) by running the Built-In Self-Test (BIST).

How to invoke the LCD BIST

1. Turn off your computer.
2. Disconnect any peripherals that are connected to the computer. Connect only the AC adapter (charger) to the computer.
3. Ensure that the LCD (screen) is clean (no dust particles on the surface of the screen).
4. Press and hold the **D** key and press the power button to enter LCD built-in self-test (BIST) mode. Continue to hold the **D** key until the computer boots up.
5. The screen displays solid colors and change colors on the entire screen to white, black, red, green, and blue twice.
6. Then it displays the colors white, black, and red.
7. Carefully inspect the screen for abnormalities (any lines, fuzzy color, or distortion on the screen).
8. At the end of the last solid color (red), the computer shuts down.

NOTE: Dell SupportAssist Preboot diagnostics upon launch initiates an LCD BIST first, expecting a user intervention to confirm functionality of the LCD.

System-diagnostic lights

This section lists the system-diagnostic lights of your Precision 3590.

Table 60. System-diagnostic lights

Blinking pattern		Problem description	Suggested resolution
Amber	White		
1	1	TPM detection failure	Replace the system board.
1	2	Unrecoverable SPI Flash Failure	Replace the system board.
1	5	EC unable to program i-Fuse	Replace the system board.
1	6	Generic catch-all for ungraceful EC code flow errors	Disconnect all power source (AC, battery, coin cell) and drain flea power by pressing and holding down the power button for 3~5 seconds.
2	1	CPU failure	<ul style="list-style-type: none"> • Run the Dell SupportAssist or Dell Diagnostics tool. • If the problem persists, replace the system board.
2	2	System board failure (included BIOS corruption or ROM error)	<ul style="list-style-type: none"> • Flash latest BIOS version • If the problem persists, replace the system board.
2	3	No memory or RAM detected	<ul style="list-style-type: none"> • Confirm that the memory module is installed properly. • If the problem persists, replace the memory module.
2	4	Memory or RAM failure	<ul style="list-style-type: none"> • Reset and swap memory modules among the slots. • If the problem persists, replace the memory module.
2	5	Invalid memory installed	<ul style="list-style-type: none"> • Reset and swap memory modules among the slots. • If the problem persists, replace the memory module.
2	6	System board or Chipset Error	Replace the system board.
2	7	LCD failure (SBIOS message)	Replace the LCD module.
2	8	Display power-rail failure on the system board	Replace the system board.
3	1	CMOS battery failure	<ul style="list-style-type: none"> • Reset the main battery connection. • If the problem persists, replace the main battery.
3	2	PCI or Video card or chip failure	Replace the system board.

Table 60. System-diagnostic lights (continued)

Blinking pattern		Problem description	Suggested resolution
Amber	White		
3	3	BIOS Recovery image not found	<ul style="list-style-type: none"> Flash latest BIOS version If the problem persists, replace the system board.
3	4	BIOS Recovery image found but invalid	<ul style="list-style-type: none"> Flash latest BIOS version If the problem persists, replace the system board.
3	5	Power rail failure	Replace the system board.
3	6	Flash corruption is detected by SBIOS.	<ul style="list-style-type: none"> Press the power button for over 25 seconds to do RTC reset. If the problem persists, replace the system board. Disconnect all power source (AC, battery, coin cell) and drain flea power by pressing and holding down the power button 3~5 seconds to ensure all power are drained. Run "BIOS recovery from USB", and the instructions are in the website Dell support. If the problem persists, replace the system board.
3	7	Timeout waiting on ME to reply to HECI message.	Replace the system board.

NOTE: Blinking 3-3-3 LEDs on Lock LED (Caps-Lock or Num-Lock), Power button LED (without Fingerprint reader), and Diagnostic LED indicates failure to provide input during LCD panel test on Dell SupportAssist Pre-boot System Performance. Check diagnostics.

Recovering the operating system

When your computer is unable to boot to the operating system even after repeated attempts, it automatically starts Dell SupportAssist OS Recovery.

Dell SupportAssist OS Recovery is a stand-alone tool that is preinstalled in Dell computers running Windows operating system. It consists of tools to diagnose and troubleshoot issues that may occur before your computer boots to the operating system. It enables you to diagnose hardware issues, repair your computer, back up your files, or restore your computer to its factory state.

You can also download it from the Dell Support website to troubleshoot and fix your computer when it fails to boot into the primary operating system due to software or hardware failures.

For more information about the Dell SupportAssist OS Recovery, see *Dell SupportAssist OS Recovery User's Guide* at [Serviceability Tools at the Dell Support Site](#). Click **SupportAssist** and then, click **SupportAssist OS Recovery**.

Real-Time Clock (RTC Reset)

The Real-Time Clock (RTC) reset function enables you or the service technician to recover Dell computers from No POST/No Power/No Boot situations. The legacy jumper enabled RTC reset has been retired on these models.

Start the RTC reset with the computer powered off and connected to AC power. Press and hold the power button for twenty seconds . The computer RTC Reset occurs after you release the power button.

Backup media and recovery options

It is recommended to create a recovery drive to troubleshoot and fix problems that may occur with Windows. Dell provides multiple options for recovering the Windows operating system on your Dell computer. For more information, see [Dell Windows Backup Media and Recovery Options](#).

Wi-Fi power cycle

About this task

If your computer is unable to access the Internet due to Wi-Fi connectivity issues, reset your Wi-Fi device by performing the following steps:

Steps

1. Turn off the computer.
2. Turn off the modem.

 **NOTE:** Some Internet service providers (ISPs) provide a modem and router combo device.

3. Turn off the wireless router.
4. Wait for 30 seconds.
5. Turn on the wireless router.
6. Turn on the modem.
7. Turn on the computer.

Drain residual flea power (perform hard reset)

About this task

Flea power is the residual static electricity that remains in the computer even after it has been powered off and the battery is removed.

For your safety, and to protect the sensitive electronic components in your computer, you must drain residual flea power before removing or replacing any components in your computer.

Draining residual flea power, also known as performing a "hard reset," is also a common troubleshooting step if your computer does not turn on or boot into the operating system.

Perform the following steps to drain the residual flea power:

Steps

1. Turn off the computer.
2. Disconnect the power adapter from the computer.
3. Remove the base cover.
4. Remove the battery.

 **CAUTION:** The battery is a Field Replaceable Unit (FRU) and the removal and installation procedures are intended for authorized service technicians only.

5. Press and hold the power button for 20 seconds to drain the flea power.
6. Install the battery.
7. Install the base cover.
8. Connect the power adapter to the computer.
9. Turn on the computer.

 **NOTE:** For more information about performing a hard reset, search in the Knowledge Base Resource at the [Dell Support Site](#).

Getting help and contacting Dell

Self-help resources

You can get information and help on Dell products and services using these self-help resources:

Table 61. Self-help resources

Self-help resources	Resource location
Information about Dell products and services	Dell Site
Tips	
Contact Support	In Windows search, type <code>Contact Support</code> , and press Enter.
Online help for operating system	Windows Support Site Linux Support Site
Access top solutions, diagnostics, drivers and downloads, and learn more about your computer through videos, manuals, and documents.	Your Dell computer is uniquely identified using a Service Tag or Express Service Code. To view relevant support resources for your Dell computer, enter the Service Tag or Express Service Code at Dell Support Site . For more information about how to find the Service Tag for your computer, see Locate the Service Tag on your computer .
Dell knowledge base articles	<ol style="list-style-type: none"> 1. Go to Dell Support Site. 2. On the menu bar at the top of the Support page, select Support > Support Library. 3. In the Search field on the Support Library page, type the keyword, topic, or model number, and then click or tap the search icon to view the related articles.

Contacting Dell

To contact Dell for sales, technical support, or customer service issues, see [Dell Support Site](#).

 **NOTE:** Availability of the services may vary depending on the country or region, and product.

 **NOTE:** If you do not have an active Internet connection, you can find contact information about your purchase invoice, packing slip, bill, or Dell product catalog.