

USER MANUAL

ProLite

LCD Monitor

ENGLISH

ProLite T2455MSC

Thank you very much for choosing the iiyama LCD monitor.

We recommend that you take a few minutes to read carefully through this brief but comprehensive manual before installing and switching on the monitor. Please keep this manual in a safe place for your future reference.



Dear user, we congratulate you on the purchase of your iiyama LCD.

For details on warranty and locally used pixel policies that apply directly after installation of your product please check the iiyama website.

To report a fault, please contact your local support centre found at <https://iiyama.com>

Things to check before you call the iiyama information line

- | if the power cable is connected securely and turned on?
- | if the display has been turned on?
- | if the signal cable is connected securely and the correct input selected?
- | if the computer has been restarted with the display connected?
- | if the graphics card is correctly installed with the latest drivers possible?
- | if the correct native resolution has been selected via 'Display Properties'?
- | If the R/G/B signal configuration is correct?
- | if the displays On Screen Menu is shown?
- | if the correct brightness and contrast settings have been set?
- | if given display tolerances and compatibility have been considered?
- | if via the On Screen Menu you have performed a Factory Reset/Recall?

Before reporting the screen defect, please prepare the following information/evidence:

- | model number *
- | purchase receipt and serial number *
- | name and address for collection
- | telephone/fax number, for availability during the day
- | convenient collection date (date, time)
- | short description of the defect

Important Note:

If there is no fault found in the collected equipment after inspection, the transferring party shall incur charges for transport and administration.

If you have checked all of the above and there is still no picture, call our information line for assistance in your country.

* see the identification plate on the back of the case.

CE MARKING DECLARATION OF CONFORMITY

This LCD monitor complies with the requirements of the EC/EU Directive 2014/30/EU "EMC Directive", 2014/35/EU "Low Voltage Directive", 2009/125/EC "ErP Directive" and 2011/65/EU "RoHS Directive".

The electro-magnetic susceptibility has been chosen at a level that gives correct operation in residential areas, business and light industrial premises and small-scale enterprises, inside as well as outside of the buildings. All places of operation are characterised by their connection to the public low voltage power supply system.

IYAMA CORPORATION: Wijkmeerstraat 8, 2131 HA Hoofddorp, The Netherlands

Model No. : PL2455M



We recommend recycling of used product. Please contact your dealer or iiyama service center. Recycle information is obtained via the Internet, using the address: <https://iiyama.com>

You can access the Web page of different countries from there.

- We reserve the right to change specifications without notice.
- All trademarks used in this user manual are the property of their respective owners.
- As an ENERGY STAR® Partner, iiyama has determined that this product meets the ENERGY STAR® guidelines for energy efficiency.
- This product qualifies for ENERGY STAR® in the "factory default" setting and this is the setting in which power saving will be achieved. Changing the factory default picture settings or enabling other features will increase power consumption that could exceed the limits necessary to qualify for ENERGY STAR® rating.
- Eprel registration number T2455MSC-B1 : 1326410

TABLE OF CONTENTS

| | |
|---|----|
| FOR YOUR SAFETY..... | 1 |
| SAFETY PRECAUTIONS..... | 1 |
| SPECIAL NOTES ON LCD MONITORS..... | 3 |
| CUSTOMER SERVICE..... | 3 |
| CLEANING..... | 3 |
| BEFORE YOU OPERATE THE MONITOR..... | 4 |
| FEATURES..... | 4 |
| CHECKING THE CONTENTS OF THE PACKAGE..... | 4 |
| INSTALLATION..... | 5 |
| CONTROLS AND CONNECTORS..... | 6 |
| CONNECTING YOUR MONITOR..... | 7 |
| COMPUTER SETTING..... | 8 |
| ADJUSTING THE VIEWING ANGLE..... | 10 |
| OPERATING THE MONITOR..... | 11 |
| ADJUSTMENT MENU CONTENTS..... | 12 |
| STANDBY FEATURE..... | 19 |
| TROUBLE SHOOTING..... | 20 |
| RECYCLING INFORMATION..... | 21 |
| APPENDIX..... | 22 |
| SPECIFICATIONS : ProLite T2455MSC-B1..... | 22 |
| DIMENSIONS..... | 23 |
| COMPLIANT TIMING..... | 23 |

FOR YOUR SAFETY

SAFETY PRECAUTIONS

WARNING

STOP OPERATING THE MONITOR IF YOU ARE AWARE OF ANY PROBLEMS

If you notice any abnormal phenomena such as smoke, strange sounds or fumes, unplug the monitor and contact your dealer or iiyama service center immediately. Further use may be dangerous and can cause fire or electric shock.

NEVER REMOVE THE CABINET

High voltage circuits are inside the monitor. Removing the cabinet may expose you to the danger of fire or electric shock.

DO NOT PUT ANY OBJECT INTO THE MONITOR

Do not put any solid objects or liquids such as water into the monitor. In case of an accident, unplug your monitor immediately and contact your dealer or iiyama service center. Using the monitor with any object inside may cause fire, electric shock or damage.

INSTALL THE MONITOR ON A FLAT, STABLE SURFACE

The monitor may cause an injury if it falls or is dropped.

DO NOT USE THE MONITOR NEAR WATER

Do not use where water may be splashed or spilt onto the monitor as it may cause fire or electric shock.

OPERATE UNDER THE SPECIFIED POWER SUPPLY

Be sure to operate the monitor only with the specified power supply. Use of an incorrect voltage will cause malfunction and may cause fire or electric shock.

PROTECT THE CABLES

Do not pull or bend the power cable and signal cable. Do not place the monitor or any other heavy objects on the cables. If damaged, the cables may cause fire or electric shock.

ADVERSE WEATHER CONDITIONS

It is advisable not to operate the monitor during a heavy thunder storm as the continual breaks in power may cause malfunction. It is also advised not to touch the plug in these circumstances as it may cause electric shock.

CAUTION

INSTALLATION LOCATION

Do not install the monitor where sudden temperature changes may occur, or in humid, dusty or smoky areas as it may cause fire, electric shock or damage. You should also avoid areas where the sun shines directly on the monitor.

DO NOT PLACE THE MONITOR IN A HAZARDOUS POSITION

The monitor may topple and cause injury if not suitably located. Please also ensure that you do not place any heavy objects on the monitor, and that all cables are routed such that children may not pull the cables and possibly cause injury.

MAINTAIN GOOD VENTILATION

Ventilation slots are provided to keep the monitor from overheating. Covering the slots may cause fire. To allow adequate air circulation, place the monitor at least 10cm (or 4 inches) from any walls. When removing the tilt stand, the ventilation slots on the back side of the monitor can be blocked. This may overheat the monitor and may cause fire or damage. Make sure to allow enough ventilation when removing the tilt stand. Operating the monitor on its back, side, upside down or on a carpet or any other soft material may also cause damage.

DISCONNECT THE CABLES WHEN YOU MOVE THE MONITOR

When you move the monitor, turn off the power switch, unplug the monitor and be sure the signal cable is disconnected. If you do not disconnect them, it may cause fire or electric shock.

UNPLUG THE MONITOR

If the monitor is not in use for a long period of time it is recommended that it is left unplugged to avoid accidents.

HOLD THE PLUG WHEN DISCONNECTING

To disconnect the power cable or signal cable, always pull it by the plug. Never pull on the cable itself as this may cause fire or electric shock.

DO NOT TOUCH THE PLUG WITH WET HANDS

Pulling or inserting the plug with wet hands may cause electric shock.

WHEN YOU INSTALL THE MONITOR ON YOUR COMPUTER

Be sure the computer is strong enough to hold the weight of the monitor, otherwise, you may damage your computer.

REMARK FOR 24/7 USAGE

This product is not specifically designed for 24/7 usage in all environments.

OTHERS

ERGONOMIC RECOMMENDATIONS

To eliminate eye fatigue, do not operate the monitor against a bright background or in a dark room. For optimal viewing comfort, the monitor should be just below eye level and 40-60 cm (16-24 inches) away from your eyes. When using the monitor over a prolonged time, a ten minute break every hour is recommended as looking at the screen continuously can cause eye strain.

SPECIAL NOTES ON LCD MONITORS

The following symptoms are normal with LCD monitors and do not indicate a problem.

- NOTE**
- When you first turn on the LCD monitor, the picture may not fit in the display area because of the type of computer that is used. In this case, adjust the picture position to the correct position.
 - You may find slightly uneven brightness on the screen depending on the desktop pattern you use.
 - Due to the nature of the LCD screen, an afterimage of the previous screen may remain after switching the image, when the same image is displayed for hours. In this case, the screen can be recovered slowly by changing the image or turning off the Power Switch for some hours.

CUSTOMER SERVICE

- NOTE**
- If you have to return your unit for service and the original packaging has been discarded, please contact your dealer or iiyama service center for advice or replacement packaging.

CLEANING

- WARNING**
- If you drop any materials or liquids such as water into the monitor when cleaning, unplug the power cable immediately and contact your dealer or iiyama service center.

- CAUTION**
- For safety reasons, turn off the power switch and unplug the monitor before you clean it.

- NOTE**
- To protect the LCD panel, do not scratch or rub the screen with a hard object.
 - Never use any of the following strong solvents. These will damage the cabinet and the LCD screen.

| | |
|------------------|--------------------------|
| Thinner | Spray-type cleaner |
| Benzene | Wax |
| Abrasive cleaner | Acid or Alkaline solvent |

- Touching the cabinet with any product made from rubber or plastic for a long time may cause degeneration or loss of paint on the cabinet.

CABINET Stains can be removed with a cloth lightly moistened with a mild detergent solvent. Then wipe the cabinet with a soft dry cloth.

LCD Periodic cleaning with a soft dry cloth is recommended.

SCREEN Don't use tissue paper etc. because these will damage the LCD screen.

BEFORE YOU OPERATE THE MONITOR

FEATURES

- ◆ Supports Resolutions up to 1920 × 1080
- ◆ High Contrast 1000:1 (Typical), Adv. Contrast Function Available / Brightness 350cd/m² (Typical: with Touch panel)
- ◆ Blue Light Reducer
- ◆ Digital Character Smoothing
- ◆ Stereo Speakers
2 × 1W Stereo Speakers
- ◆ Standby Feature
- ◆ VESA Mounting Standard (100mm×100mm) Compliant
- ◆ Keyhole for Security Lock

CHECKING THE CONTENTS OF THE PACKAGE

The following accessories are included in your package. Check to see if they are enclosed with the monitor. If anything is missing or damaged, please contact your local iiyama dealer or regional iiyama office.

- | | | |
|----------------|----------------|---------------------|
| ■ Power Cable* | ■ HDMI Cable | ■ USB Cable |
| ■ Spiral tube | ■ Safety Guide | ■ Quick Start Guide |

CAUTION

- * The rating of the Power Cable enclosed in 120V area is 10A/125V. If you are using a power supply higher than this rating, then a power cable with a rating of 10A/250V must be used. However, all guarantees and warranties are void for any problems or damage caused by a power cable not supplied by iiyama. An approved power cable greater or equal to H05VVF, 3G, 0.75mm² must be used.

INSTALLATION

CAUTION

- Before installation, make sure the wall, ceiling or desktop arm is strong enough to hold the necessary weight of the display and the mount.

< WALL MOUNTING >

CAUTION

- When you use with the wall mounting, in consideration of thickness of the mounting stage, tighten the M4 Screws (4pcs) which “L” length is 11mm to fasten the monitor. Using the screw longer than this may cause electric shock or damage because it may contact with the electrical parts inside the monitor.

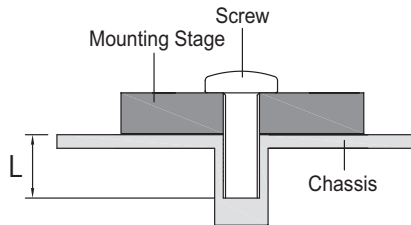

[ROTATING THE MONITOR]

The monitor is designed to be compatible only with the landscape mode.

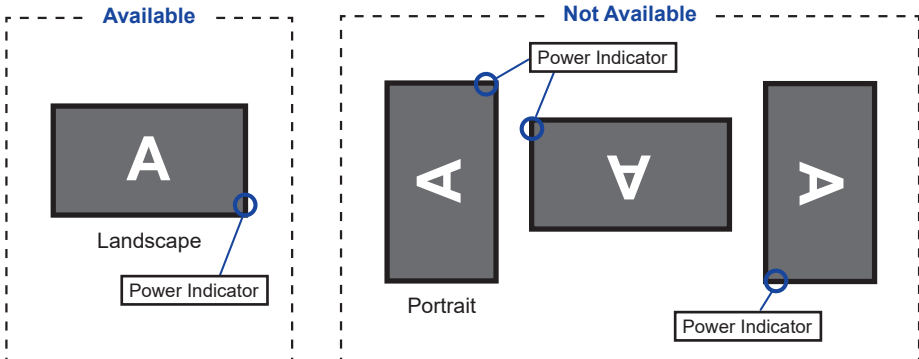

CONTROLS AND CONNECTORS

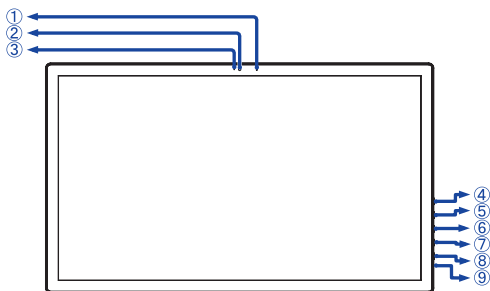

<Front>

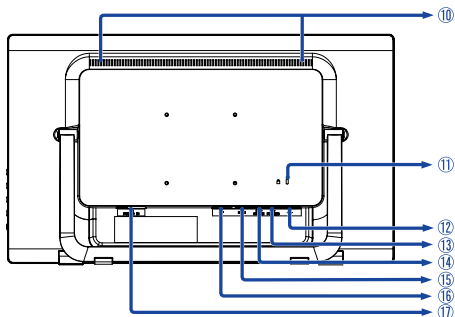

<Back>

- ① Microphone
- ② Web Camera
- ③ Web Camera Indicator
 - NOTE** Light indicating webcam is on.
- ④ Menu Button (①)
- ⑤ Scroll up / Eco Button (▲)
- ⑥ Scroll down / Volume Button (▼)
- ⑦ Select / Input select Button (②)
- ⑧ Power Switch (⏻)
- ⑨ Power Indicator
 - NOTE** Blue: Normal operation
 - Orange: Standby mode
- ⑩ Speakers
- ⑪ Keyhole for Security Lock
 - NOTE** You can fasten a security lock and cable to prevent the monitor from being removed without your permission.
- ⑫ USB Downstream Connector (⚡ 5V, 900mA)
- ⑬ USB Upstream Connector (⚡ PC USB)
- ⑭ Headphone Connector (EARPHONE)
- ⑮ HDMI Connector (HDMI)
- ⑯ DisplayPort Connector (DP)
- ⑰ AC Connector(~ : Alternating current) (AC POWER IN)

CONNECTING YOUR MONITOR

- ① Ensure that both the computer and the monitor are switched off.
- ② Connect the computer to the monitor with the signal cable.
- ③ Connect the computer to the monitor with the USB Cable.
- ④ Connect the Power Cable to the monitor first and then to the power source.
- ⑤ Turn on your monitor and computer.

NOTE

- Make sure that the building installation has a circuit breaker of 120/240V, 20A (maximum).
- The signal cables used for connecting the computer and monitor may vary with the type of computer used. An incorrect connection may cause serious damage to both the monitor and the computer. The cable supplied with the monitor is for a standard connector. If a special cable is required please contact your local iiyama dealer or regional iiyama office.
- Make sure you tighten the finger screws at each end of the signal cable.
- The Class I pluggable equipment Type A must be connected to protective earth.
- The socket-outlet shall be installed near the equipment and shall be easily accessible.
- Excessive sound pressure from ear-/headphones can cause hearing damage/hearing loss.

[Example of Connection]

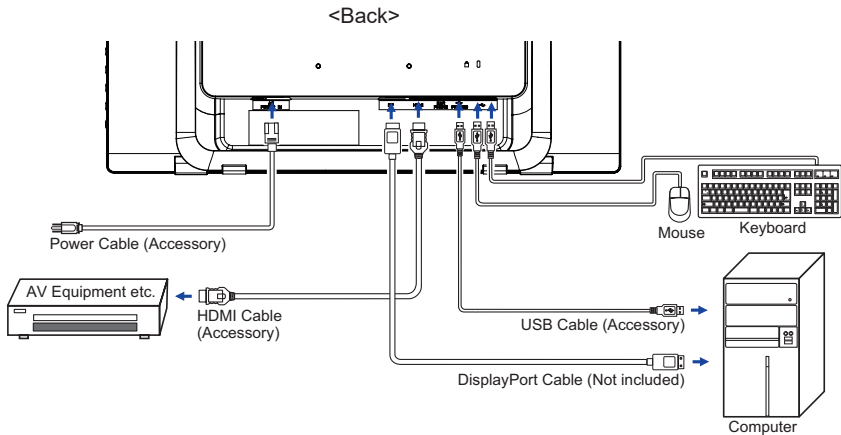

COMPUTER SETTING

■ Signal Timing

Change to the desired signal timing listed on page 23: COMPLIANT TIMING.

■ TOUCH support operation system

| | Mouse | Digitizer | Gestures* ¹ |
|-----------------|-------------------------------|---|---|
| Windows8/8.1/10 | ○ | ○ | ○ |
| Windows7 | ○ | ○ | ○ |
| Windows Vista | ○ | ○ | × |
| Windows XP | × | × | × |
| Mac OS/OS X | × | × | × |
| Linux | ○ | × | × |
| Android | × | × | × |
| Functions | Click Drag Double-Click | Mouse function Right-Click Flick Visual feedback | Mouse & Digitizer functions Press & Tap, Rotate, Zoom-in/out |

The other OS Versions not listed are not supported.

○ : Supported × : Not supported

*¹ Gestures can be supported by application programs.

■ Touch Input Settings in Dual Screen Mode

① Connect the primary monitor to the computer first.

Set Control Panel > Hardware and Sound > Tablet PC Settings > Display > Setup.

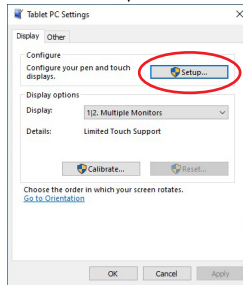
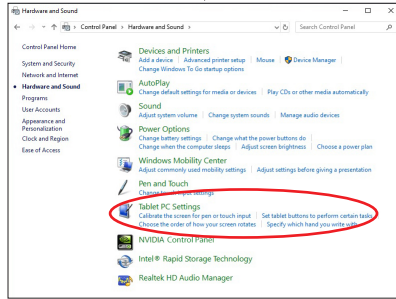
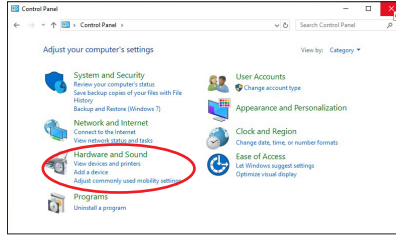

The following message will appear on the screen. Please follow the instructions.

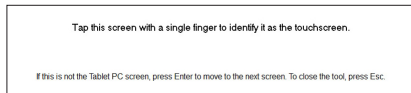

② After setting ①, connect a second monitor and perform the setup as in ①.

NOTE The monitors are recognized as dual-display, and touch operation cannot be performed on two monitors at the same time.

You can perform touch operation on only one of the monitors.

ADJUSTING THE VIEWING ANGLE

- For optimal viewing it is recommended to look at the full face of the monitor.
 - You are able to adjust the monitor's angle up to 15 - 65 degrees upward.
- ① Put a piece of soft cloth on the table beforehand to prevent the monitor from being scratched. Lay the monitor flat on a table with front face down.
 - ② Hold the monitor and pull the stand up until you hear a click.
 - ③ Stand the monitor in the upright position. Adjust the screen tilt to your preference.

NOTE

- Do not touch the LCD screen when you change the angle. It may cause damage or break the LCD screen.
- Careful attention is required not to pinch your fingers or hands into the moving part of the stand when you change the angle.
- When packaged, the stand is folded. Do not use in this state otherwise injury may occur if it falls or is dropped.

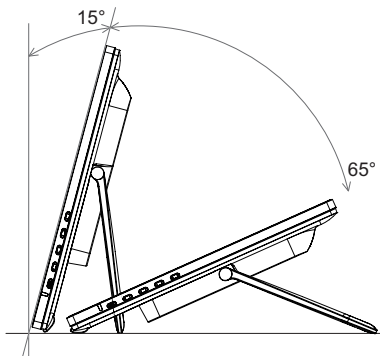

OPERATING THE MONITOR

To create the best picture, your iiyama LCD monitor has been preset at the factory with the COMPLIANT TIMING shown on page 23. You are also able to adjust the picture by following the button operation shown below.

- ① Press the ① Button to start the On Screen Display (OSD) feature. There are additional Menu items which can be switched by using the ▲ / ▼ Buttons.



- ② Select the Menu item which contains the adjustment icon relating to the adjustment you want to make. Press the ② Button. Then, use the ▲ / ▼ Buttons to highlight the desired adjustment icon.
- ③ Press the ② Button again. Use the ▲ / ▼ Buttons to make the appropriate adjustment or setting.
- ④ Press the ① Button to leave the menu, and the settings you just made would be automatically saved.

For example, to correct for OSD vertical position, select Menu item of OSD and then press the ② Button. Then, select OSD Vertical Position by using the ▲ / ▼ Buttons.

An adjustment page appears after you press the ② Button. Then, use the ▲ / ▼ Buttons to change the OSD vertical position settings.

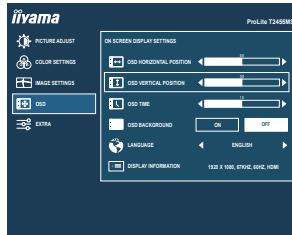

Press the ① Button lastly, it ends, all changes are saved in the memory.

NOTE

- When button operations are aborted during adjustment, On-Screen Display disappears when the time set for the OSD Time has passed. Also, the ① button can be used to return previous menu and turn off the On-Screen Display.
- Any changes are automatically saved in the memory when the On Screen Display disappears. Turning off the power should be avoided while using the Menu.
- All adjustments have only one setting which applies to all signal timings.

ADJUSTMENT MENU CONTENTS



Picture Adjust

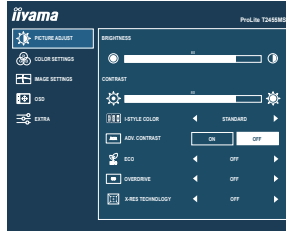

| Adjustment Item | Problem / Option | | Button to Press |
|--|------------------|---|---|
| Brightness *1,2 | Too dark | | |
| | Too bright | | |
| Contrast *1 | Too dull | | |
| | Too intense | | |
| i-Style Color *1,2,3 | Off | Return to a state set by color adjustment except i-Style Color. | |
| | Standard | For general windows environment and monitor default setting. | |
| | Game | For PC game environment. | |
| | Cinema | For movie and video environment. | |
| | Scenery | For displaying outdoor scenery images | |
| | Text | For text editing and viewing in a word processing environment. | |
| Adv. Contrast *1 | On | Increased Contrast Ratio | |
| | Off | Typical Contrast Ratio | |
| <p>NOTE Adv. Contrast adjusts brightness according to the image, and improve the contrast ratio during movie playing. Contrast, Brightness, i-Style Color, Eco, Gamma and Color Temp. cannot be adjusted and selected while Adv. Contrast is active.</p> | | | |
| Eco *1 | Direct | Off | Normal |
| | | Mode1 | Brightness of back-light is reduced. |
| | | Mode2 | Brightness of back-light is reduced more than Mode 1. |
| | | Mode3 | Brightness of back-light is reduced more than Mode2. |

Direct



You can skip the Menu items and directly display an option setting screen by using the following button operations.

- Eco: Press the ▲ Button when the Menu is not displayed.

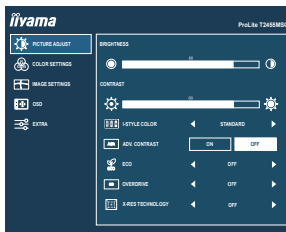

Picture Adjust



| Adjustment Item | Problem / Option | Button to Press |
|------------------|--|---|
| Overdrive *4 | Off / 1 / 2 / 3 / 4 / 5 It will improve the gray level response time of the LCD panel. A higher level results in a faster response time. |    |
| X-Res Technology | Off | Normal |
| | Soft | Enhance the picture edge. |
| | Middle | Enhance the picture edge more than the Soft option. |
| | Hard | Enhance the picture edge more than the Middle option. |

*1 The availability of each item depends on which item is activated. See page 18 Function Correlation Matrix for more details.

*2 Adjust the Brightness when you are using the monitor in a dark room and feel the screen is too bright.

*3 i-Style Color is disabled when Blue Light Reducer is activated.

*4 When Overdrive is activated, some level of image retention will be caused.



Color Settings *1

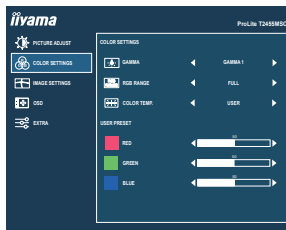

| Adjustment Item | Problem / Option | | Button to Press | |
|-----------------|------------------|---|------------------------|--|
| Gamma *2 | Gamma 1 | High contrast | | |
| | Gamma 2 | Normal | | |
| | Gamma 3 | Dark | | |
| RGB Range | Full | For full-range color scale signalscale signal | | |
| | Limited | For limited color scale signal | | |
| Color Temp. *2 | User | Red | Too weak Too strong | |
| | | Green | | |
| | | Blue | | |
| | Cool | Cool color | | |
| | Normal | Normal color | | |
| Warm | Warm color | | | |



*1 Color Settings are disabled when Blue Light Reducer is activated.

*2 The availability of each item depends on which item is activated. See page 18 Function Correlation Matrix for more details.

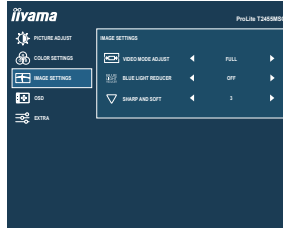

Image Settings



| Adjustment Item | Problem / Option | Button to Press |
|-----------------------|---|---|
| Video Mode Adjust *1 | Full | Expansion display |
| | Aspect | Expansion display of Aspect |
| Blue Light Reducer *2 | Off | Typical |
| | Mode 1 | Blue light is reduced. |
| | Mode 2 | Blue light is reduced more than Mode 1. |
| | Mode 3 | Blue light is reduced more than Mode 2. |
| Sharp and Soft | 1 / 2 / 3 / 4 / 5 / 6 You can change the picture quality from 1 to 6 (sharp to soft). Press the ▲ Button to change the picture quality in numerical order. Press the ▼ Button to change the picture quality in reverse numerical order. |    |

*1 It can display in the center of the screen with a 4:3, 5:4 or 16:10 aspect ratio when input video resolution is 4:3, 5:4 or 16:10.

*2 Blue Light Reducer cannot be enabled if i-Style Color, Adv.Contrast or Eco is enabled.

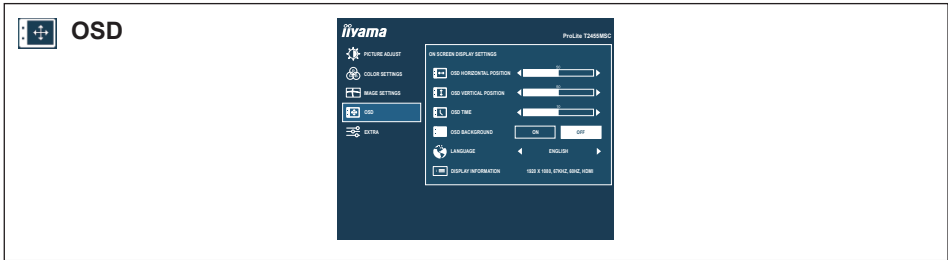

| Adjustment Item | Problem / Option | | Button to Press | |
|-------------------------|---|--|-----------------|----------|
| OSD Horizontal Position | OSD is too left OSD is too right | | | |
| OSD Vertical Position | OSD is too low OSD is too high | | | |
| OSD Time | You can set the OSD display duration time between 5 and 60 seconds. | | | |
| OSD Background | On | The background of OSD is made transparent. | | |
| | Off | Return the background of OSD. | | |
| Language | English | English | Česky | Czech |
| | Français | French | Italiano | Italian |
| | Deutsch | German | Русский | Russian |
| | Nederlands | Dutch | 日本語 | Japanese |
| | Polski | Polish | | |
| Display Information | <p>Displays information regarding the current input signal coming from the graphic card in your computer.</p> <p>NOTE See your graphic card user guide for more information about changing the resolution and refresh.</p> | | | |



Extra

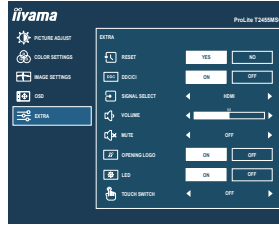

ENGLISH

| Adjustment Item | Problem / Option | | Button to Press |
|---|------------------|--|-----------------|
| Reset | Yes | Factory-preset data is restored. | |
| | No | Return to Menu. | |
| DDC/CI | On | DDC/CI is On. | |
| | Off | DDC/CI is Off. | |
| Signal Select Direct | Auto | Select the signal input automatically. | |
| | HDMI | Select the Digital (HDMI) input. | |
| | DisplayPort | Select the Digital (DisplayPort) input. | |
| NOTE If "Auto" is selected, only one source available is selected automatically. Input source is fixed, not selected automatically when HDMI and DisplayPort are selected. | | | |
| Volume Direct | Too soft | | |
| | Too loud | | |
| Mute Direct | On | Turn off the sound temporarily. | |
| | Off | Return the sound volume to the previous level. | |
| Opening Logo | On | Opening Logo is On. | |
| | Off | Opening Logo is Off. | |
| LED | On | The Power Indicator is turned On. | |
| | Off | The Power Indicator is turned Off. | |
| NOTE Turn Off the Power Indicator when you are bothered by the light. | | | |
| Touch Switch * | Off | Normal touch (with bare hands or stylus device) | |
| | Glove | Touch with gloved hand (Supports thickness +2mm) | |

* Please turn on the power and set the Touch Switch after the monitor installation is completed. Turning on the power and setting the Touch Switch before the monitor installation may cause misalignment or malfunction of the touch calibration.

Direct

You can skip the Menu items and directly display an option setting screen or an adjustment scale by using the following button operations.

- Volume: Press the ▼ Button when the Menu is not displayed.
- Mute: Pressing and holding of the ▼ Button for about 2 seconds when the Menu is not displayed. Mute and Unmute are switched as follows by pressing the ▼ Button successively.
- Signal Select: Press the ② Button when the Menu is not displayed, it shows following Menu.



- Lock Mode:

<OSD>

Pressing and holding the ① button for 5 seconds when Menu is not displayed, it will lock/unlock the OSD Lock function.

<Power>

Pressing and holding the ② button for 5 seconds when Menu is not displayed, will lock/unlock the Power Lock function.

■ Function Correlation Matrix

| Item to be selected Item activated | Picture Adjust | | | | | Color Settings | |
|---------------------------------------|----------------|------------|---------------|---------------|-----|----------------|-------------|
| | Contrast | Brightness | i-Style Color | Adv. Contrast | Eco | Gamma | Color Temp. |
| i-Style Color | — | — | — | — | — | — | ✓ |
| Adv. Contrast | — | — | — | — | — | — | — |
| Eco | ✓ | — | ✓ | ✓ | — | ✓ | ✓ |

✓ : Available

— : Not available

STANDBY FEATURE

This product features the standby function. When activated, it automatically reduces unnecessary power consumption of the monitor when your computer is not in use.

There is a standby step the monitor takes as described below. The standby function, including any timer settings is configured by the operating system. Check your operating system manual for information on how this can be configured.

■ Standby Mode

When the video signal from the computer is off, the monitor enters into Standby Mode which reduces the power consumption to less than 1.5W*. The screen becomes dark, and the power indicator turns to orange. From Standby Mode, the image reappears in several seconds when either the keyboard or the mouse are touched again.

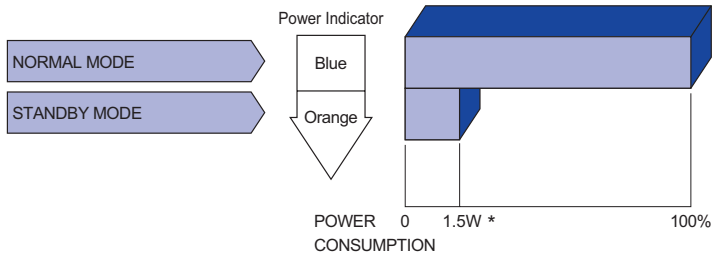

* When the USB devices are not connected.

TROUBLE SHOOTING

If the monitor fails to operate correctly, please follow the steps below for a possible solution.

1. Perform the adjustments described in OPERATING THE MONITOR, depending on the problem you have. If the monitor does not get a picture, skip to 2.
2. Consult the following items if you cannot find an appropriate adjustment item in OPERATING THE MONITOR or if the problem persists.
3. If you are experiencing a problem which is not described below or you cannot correct the problem, discontinue using the monitor and contact your dealer or iiyama service center for further assistance.

Problem

Check

- ① The picture does not appear.

(Power indicator does not light up.)

- The Power Cable is firmly seated in the socket.
- The Power Switch is turned ON.
- The AC socket is live. Please check with another piece of equipment.

(Power indicator is blue.)

- If the blank screen saver is in active mode, touch the keyboard or the mouse.
- Increase the Contrast and/or Brightness.
- The computer is ON.
- The Signal Cable is properly connected.
- The signal timing of the computer is within the specification of the monitor.

(Power indicator is orange.)

- If the monitor is in standby mode, touch the keyboard or the mouse.
- The computer is ON.
- The Signal Cable is properly connected.
- The signal timing of the computer is within the specification of the monitor.

- ② The screen is not synchronized.

- The Signal Cable is properly connected.
- The signal timing of the computer is within the specification of the monitor.

- ③ The screen position is not in the center.

- The signal timing of the computer is within the specification of the monitor.

- ④ The screen is too bright or too dark.

- The video output level of the computer is within the specification of the monitor.

- ⑤ The screen is shaking.

- The power voltage is within the specification of the monitor.
- The signal timing of the computer is within the specification of the monitor.

- ⑥ No sound.

- The audio equipment (computer etc.) is ON.
- The Audio Cable is properly connected.
- The Volume is turned up.
- The Mute is OFF.
- The audio output level of the audio equipment is within the specification of the monitor.

| Problem | Check |
|--|---|
| ⑦ The sound is too loud or too quiet. | <input type="checkbox"/> The audio output level of the audio equipment is within the specification of the monitor. |
| ⑧ A strange noise is heard. | <input type="checkbox"/> The Audio Cable is properly connected. |
| ⑨ The touch screen shows no response. | <input type="checkbox"/> The USB Cable is firmly seated in the socket. <input type="checkbox"/> Touch screen driver software is installed. |
| ⑩ The touch position does not deviate. | <input type="checkbox"/> The calibration function set up correctly. |

RECYCLING INFORMATION

For better environment protection please don't dispose your monitor.
Please visit our web site: <https://iiyama.com> for monitor recycling.

APPENDIX

Design and specifications are subject to change without prior notice.

SPECIFICATIONS : ProLite T2455MSC-B1

| | | |
|---------------------------------------|----------------------|---|
| Touch Screen | Technology | Projected capacitive 10pt touch |
| | Light transmission | 87% |
| | Communication system | USB |
| Size Category | | 24" |
| LCD Panel | Panel technology | IPS |
| | Size | Diagonal: 23.8" (60.47cm) |
| | Pixel pitch | 0.2745mm H × 0.2745mm V |
| | Brightness | 400cd/m ² (Typical: without Touch panel), 350cd/m ² (Typical: with Touch panel), 305cd/m ² (Default / Energy Saving) |
| | Contrast ratio | 1000 : 1 (Typical: with Touch panel), Adv. Contrast Function Available |
| | Viewable angle | Right / Left : 89 degrees each, Up / Down: 89 degrees each (Typical) |
| | Response time | 14ms (Typical), 5ms (Gray to Gray) ^{*3} |
| Display Colors | | Approx. 16.7M |
| Sync Frequency | | Horizontal: 30.0-83.0kHz, Vertical: 55-76Hz |
| Native Resolution | | 1920 × 1080, 2.1 MegaPixels |
| Supported max. resolution | | 1920 × 1080 60Hz |
| Input Connector | | HDMI, DisplayPort |
| Input Video Signal | | HDMI, DisplayPort |
| USB Standard | | USB3.0 (DC5V, 900mA) |
| Number of USB Ports | | 1 Upstream : Series B |
| Connector shape | | 2 Downstream : Series A |
| Headphone Connector | | ø 3.5mm mini jack (Stereo) |
| Speakers | | 1W × 2 (Stereo speakers) |
| Web Camera | | 0.9 MegaPixels |
| Maximum Screen Size | | 527.04mm W × 296.46mm H / 20.7" W × 11.7" H |
| Power Source | | 100-240VAC, 50/60Hz, 0.8A |
| Power Consumption ^{*1} | | 18W typical, Standby mode: 1.5W maximum, Off mode: 0.3W maximum |
| Dimensions ^{*2} / Net Weight | | 566.0 × 337.5 × 43.5mm / 22.3 × 13.3 × 1.7" (W×H×D) 4.4kg / 9.7lbs |
| Tilt Angle | | Upward: 15 - 65 degrees |
| Environmental Considerations | | Operating: Temperature 5 to 35°C / 41 to 95°F Humidity 10 to 90% (No condensation) Storage: Temperature -20 to 60°C / -4 to 140°F Humidity 10 to 90% (No condensation) |
| Approvals | | CE, UKCA, TÜV-Bauart, VCCI, PSE, EAC |

NOTE ^{*1} When the USB devices are not connected.

^{*2} When the stand is closed.

^{*3} When set to Overdrive +5.

DIMENSIONS

* When the stand is closed.

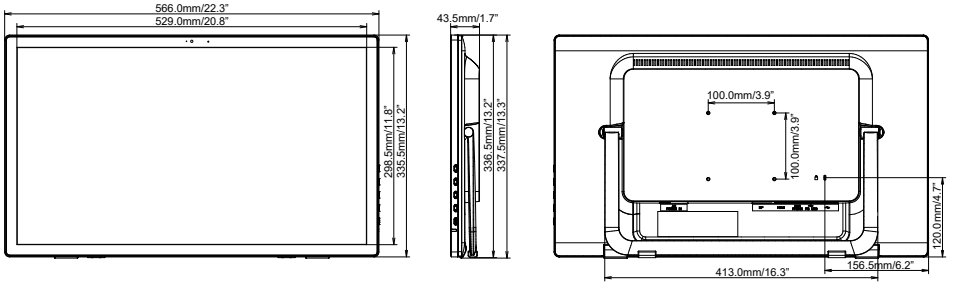

ENGLISH

COMPLIANT TIMING

| Video Mode | Horizontal Frequency | Vertical Frequency | Dot Clock |
|-------------|----------------------|--------------------|------------|
| 640 × 480 | 31.469kHz | 59.940Hz | 25.175MHz |
| | 37.500kHz | 75.000Hz | 31.500MHz |
| | 37.861kHz | 72.809Hz | 31.500MHz |
| 800 × 600 | 35.156kHz | 56.250Hz | 36.000MHz |
| | 37.879kHz | 60.317Hz | 40.000MHz |
| | 46.875kHz | 75.000Hz | 49.500MHz |
| 1024 × 768 | 48.363kHz | 60.004Hz | 65.000MHz |
| | 56.476kHz | 70.069Hz | 75.000MHz |
| | 60.023kHz | 75.029Hz | 78.750MHz |
| 1280 × 1024 | 63.981kHz | 60.020Hz | 108.000MHz |
| | 79.976kHz | 75.025Hz | 135.000MHz |
| 1440 × 900 | 55.935kHz | 59.887Hz | 106.500MHz |
| 1680 × 1050 | 65.290kHz | 60.000Hz | 146.250MHz |
| 1920 × 1080 | 66.590kHz | 59.930Hz | 138.500MHz |